

The logo for Mintyre Building Products. The word "Mintyre" is written in a bold, white, sans-serif font with a registered trademark symbol (®) at the end. Below it, the words "BUILDING PRODUCTS" are written in a smaller, white, sans-serif font, all contained within a red rectangular bar.

Mintyre[®]
BUILDING PRODUCTS

PRODUCT
INFORMATION

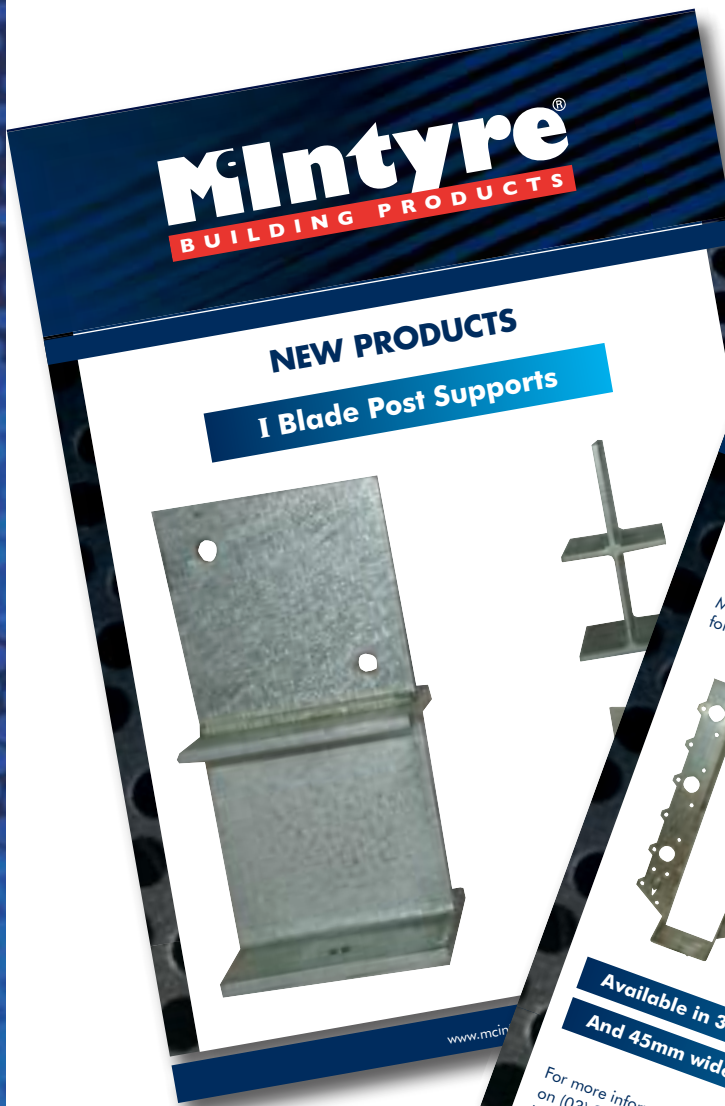

BUILDING PRODUCTS

McIntyre manufacture and distribute our extensive range of Timber Connectors, Post Supports, Metal Door Frames, Wall & Roof Bracing, Insulation Foil & Wrap, Brickties and Masonry products to Timber & Hardware retail outlets throughout Australia.

We also supply selected Building Products from our range, as well as Galvanised and Primed Flats, Angles and T.Bars, to Sand & Soil retail outlets in Victoria.

If you are a retailer of Builder's Hardware or if you operate a Sand & Soil retail outlet, and if you'd like some more information about our range, please feel free to contact one of our Sales Representatives or Customer Service staff to assist you.

We deliver daily to our customers, using McIntyre Trucks and Drivers so that we can provide you Quality Building Products and Friendly, Reliable Service.

For further information, please visit
www.mcintyresteel.com.au

McIntyre Steel Industries (Vic) Pty Ltd ABN 87 005 401 187
 176 – 178 McIntyre Road, North Sunshine, Victoria 3020
 Phone (03) 9311 0380 Fax (03) 9311 7221
sales@mcintyresteel.com.au

INDEX

Ant Caps	12	Multi Purpose Brackets – Zinc	16–17
Bitumen Malthoid – Dampcourse	11	Multi Purpose Brackets – Galvanised	17–20
Bitumen Alcor – Coated Aluminum	11	No Sag Easy Gate	10
Bracket Nails	7	Pergola Angle	9
Brick Ties	12	Plaster Angle	21
Damp Cor	11	Post Supports	2–4
ExFoam Expansion Foam	11	Safety Barrier Mesh	10
Expansion Ties	12	Shadetak	7
Flash Tape	11	Sisaltak	12
Flexembly	9	Steel Gate Frame Kit	10
Groupnail	7	Steel Lintels – Painted	21–22
Hangabrackets	4–5	Steel Lintels – Galvanised	23–24
Heavy Duty HYBeam Nails	7	Steel Pit Frames & Grate Sets	24
Holistrap	10	Sub Floor Access Doors	16
Hooknail	6	Timber Connectors	8–9
Hyspan & I Beam Brackets	5	Vents	10
Insulation Foil & Weatherproof Wrap	11	Wall & Roof Bracing	20
Metal Door Frames	13–15	Wire Ties	12
Mininail & Shadetak	7		

TO ORDER

FAX: (03) 9311 7221
PHONE: (03) 9311 0380

ORDERS UNDER \$250 WILL INCUR A SURCHARGE OF \$20
A FREIGHT CHARGE OF \$15.00 APPLIES TO ALL
DELIVERIES IN VICTORIA.

DEAR CUSTOMER

- To assist in the timely processing of orders, please quote the appropriate product code. Orders may be faxed into our customer service staff on (03) 9311 7221, emailed to sales@mcintyresteel.com.au or phoned through on (03) 9311 0380.
- Please feel free to ask your McIntyre Building Products representative about our merchandising bins & racks.
- Brackets nails are available to suit the full range of McIntyre timber connectors, including the heavy duty range of brackets.
- Should you require more information regarding our range of products & services please phone our customer service staff on (03) 9311 0380.
- Please note that a GST of 10% applies to all purchases of McIntyre Steel products.

McIntyre Steel Industries, proud to be an Australian Owned company

McIntyre® is a Registered Trademark of McIntyre Steel Industries (Vic.) Pty. Ltd.

Post Supports

PRODUCT NAME	CODE	QTY	WHL SALE	APN CODE
Full Stirrup – 3mm thick stirrup, 32mm diameter shaft				
65mm shaft x 90mm stirrup	FS65/90	10		9316101000322
65mm shaft x 100mm stirrup	FS65/100	10		9316101000315
125mm shaft x 90mm stirrup	FS125/90	10		9316101901254
125mm shaft x 100mm stirrup	FS125/100	10		9316101101258
125mm shaft x 115mm stirrup	FS125/115	10		9316101003828
125mm shaft x 125mm stirrup	FS125/125	10		9316101003798
150mm shaft x 90mm stirrup	FS150/90	10		9316101004702
150mm shaft x 100mm stirrup	FS150/100	10		9316101004719
150mm shaft x 115mm stirrup	FS150/115	10		9316101000483
150mm shaft x 120mm stirrup	FS150/120	10		9316101050136
150mm shaft x 125mm stirrup	FS150/125	10		9316101000476
150mm shaft x 150mm stirrup	FS150/150	10		9316101050044
200mm shaft x 90mm stirrup	FS200/90	10		9316101000346
200mm shaft x 100mm stirrup	FS200/100	10		9316101000339
225mm shaft x 90mm stirrup	FS225/90	10		9316101004726
225mm shaft x 100mm stirrup	FS225/100	10		9316101004733
250mm shaft x 90mm stirrup	FS250/90	10		9316101902503
250mm shaft x 100mm stirrup	FS250/100	10		9316101102507
250mm shaft x 115mm stirrup	FS250/115	10		9316101003835
250mm shaft x 120mm stirrup	FS250/120	10		9316101050273
250mm shaft x 125mm stirrup	FS250/125	10		9316101000506
300mm shaft x 90mm stirrup	FS300/90	10		9316101000360
300mm shaft x 100mm stirrup	FS300/100	10		9316101000353
300mm shaft x 115mm stirrup	FS300/115	10		9316101000520
300mm shaft x 120mm stirrup	FS300/120	10		9316101050150
300mm shaft x 125mm stirrup	FS300/125	10		9316101000513
300mm shaft x 135mm stirrup	FS300/135	10		9316101050402
300mm shaft x 150mm stirrup	FS300/150	10		9316101050051
375mm shaft x 90mm stirrup	FS375/90	10		9316101903753
375mm shaft x 100mm stirrup	FS375/100	10		9316101103757
375mm shaft x 115mm stirrup	FS375/115	10		9316101003996
375mm shaft x 120mm stirrup	FS375/120	10		9316101050167
375mm shaft x 125mm stirrup	FS375/125	10		9316101000582
375mm shaft x 135mm stirrup	FS375/135	10		9316101050419
450mm shaft x 90mm stirrup	FS450/90	10		9316101000384
450mm shaft x 100mm stirrup	FS450/100	10		9316101000377
450mm shaft x 115mm stirrup	FS450/115	10		9316101003804
450mm shaft x 125mm stirrup	FS450/125	10		9316101003811
450mm shaft x 135mm stirrup	FS450/135	10		9316101050426
450mm shaft x 150mm stirrup	FS450/150	10		9316101050068
500mm shaft x 90mm stirrup	FS500/90	10		9316101000407
500mm shaft x 100mm stirrup	FS500/100	10		9316101000391
500mm shaft x 115mm stirrup	FS500/115	10		9316101000605
500mm shaft x 120mm stirrup	FS500/120	10		9316101050174
500mm shaft x 125mm stirrup	FS500/125	10		9316101000544
600mm shaft x 90mm stirrup	FS600/90	5		9316101000421
600mm shaft x 100mm stirrup	FS600/100	5		9316101000414

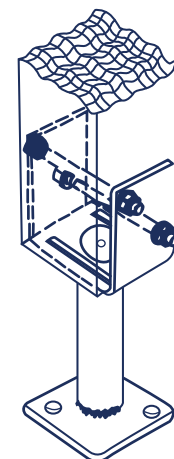
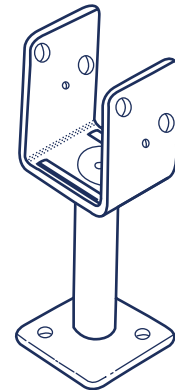

Post Supports

PRODUCT NAME	CODE	QTY	WHL SALE	APN CODE
Half Stirrup – 3mm thick stirrup				
65mm shaft	HSPS/65	10		9316101004740
125mm shaft	HSPS/125	10		9316101001251
200mm shaft	HSPS/200	10		9316101001800
250mm shaft	HSPS/250	10		9316101000735
300mm shaft	HSPS/300	10		9316101001817
375mm shaft	HSPS/375	10		9316101000742
500mm shaft	HSPS/500	10		9316101000759

Pin Type – 3mm thick bottom plate				
125mm shaft	PPS/125	10		9316101011250
150mm shaft	PPS/150	10		9316101050181
200mm shaft	PPS/200	10		9316101002074
250mm shaft	PPS/250	10		9316101000766
300mm shaft	PPS/300	10		9316101002081
375mm shaft	PPS/375	10		9316101000773
500mm shaft	PPS/500	10		9316101000780

Blade				
125mm shaft	BLPS/125	10		9316101000797
150mm shaft	BLPS/150	10		9316101003873
200mm shaft	BLPS/200	10		9316101000803
250mm shaft	BLPS/250	10		9316101000810
300mm shaft	BLPS/300	10		9316101000827
375mm shaft	BLPS/375	10		9316101000834
500mm shaft	BLPS/500	10		9316101000841

Heavy Duty Blade NEW				
125mm	IB125	1		9316101051102
150mm	IB150	1		9316101051119

Bolt On – 3mm stirrup & base, hot dipped galvanised				
90mm stirrup	BOPS/90	10		9316101000865
100mm stirrup	BOPS/100	10		9316101000858
115mm stirrup	BOPS/115	10		9316101003842
120mm stirrup	BOPS/120	10		9316101050143
125mm stirrup	BOPS/125	10		9316101001961
135mm stirrup	BOPS/135	10		9316101050396
140mm Stirrup	BOPS/140	10		9316101050945
150mm stirrup	BOPS/150	10		9316101050372
200mm stirrup	BOPS/200	2		9316101051065

Bolt on Post Anchor – Galvabond – 2mm Stirrup – 3mm Base				
90mm Stirrup	GBPS90	10		9316101251366
100mm Stirrup	GBPS100	10		9316101251373

Adjustable Post Supports				
75mm shaft	ASPS/75	10		9316101000889
125mm shaft	ASPS/125	8		9316101000896

Fed Trim Range				
Fedkit post cover – 105mm deep				
Clip on post base cover for posts, 90/100mm	PC1	1		9311006500182
Cap it all trim kit – 70mm deep				
Clip on post top trim for posts, 90 to 135mm	CTK1	1		9311006501004
Cover all post cover – 295mm deep				
Adj. clip on post base cover for posts, 90 to 135mm	CPC1	1		9311006502001

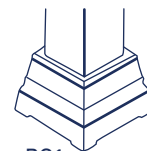
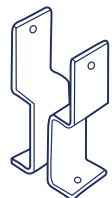
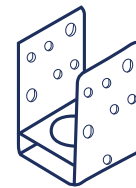
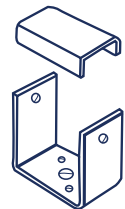
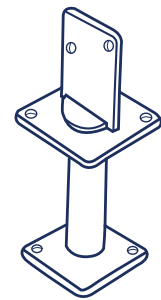
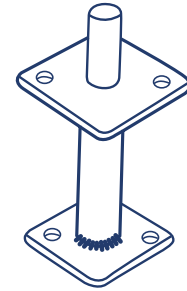
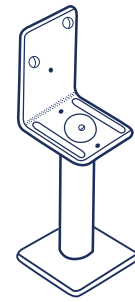

PC1



CTK1



CPC1

Post Supports

PRODUCT NAME	CODE	QTY	WHLSALE	APN CODE
Colonial Type - Aluminium				
90mm	COL/90	5		9316101000926
100mm	COL/100	5		9316101050204

Cyclonic				
300mm L x 50mm W, 90mm post	CY300/90	5		9316101004344
300mm L x 50mm W, 100mm post	CY300/100	5		9316101004351
450mm L x 50mm W, 90mm post	CY450/90	5		9316101004368
450mm L x 50mm W, 100mm post	CY450/100	5		9316101000902
600mm L x 50mm W, 90mm post	CY600/90	5		9316101004375
600mm L x 50mm W, 100mm post	CY600/100	5		9316101000919
600mm L x 50mm W, 125mm post	CY600/125	5		9316101004757
600mm L x 50mm W, 150mm post	CY600/150	5		9316101051058

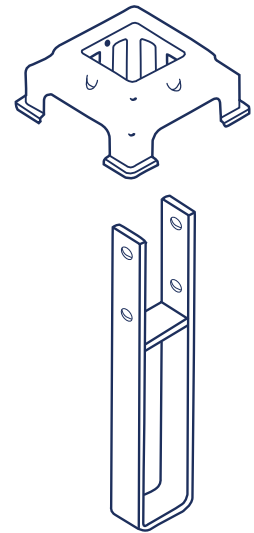

Hangabrackets

Hangabacket				
35 x 60mm	HB3560	40		9316101000940
35 x 90mm	HB3590	40		9316101000957
35 x 120mm	HB35120	40		9316101000964
35 x 140mm	HB35140	40		9316101000971
35 x 180mm	HB35180	40		9316101002166
38 x 60mm	HB3860	40		9316101000988
38 x 90mm	HB3890	40		9316101000995
38 x 120mm	HB38120	40		9316101001008
38 x 140mm	HB38140	40		9316101001015
38 x 180mm	HB38180	40		9316101001022
38 x 220mm	HB38220	20		9316101001039
45 x 60mm	HB4560	40		9316101001046
45 x 90mm	HB4590	40		9316101001053
45 x 120mm	HB45120	40		9316101001060
45 x 140mm	HB45140	40		9316101001077
45 x 180mm	HB45180	40		9316101001084
45 x 220mm	HB45220	20		9316101001091
50 x 60mm	HB5060	40		9316101001107
50 x 90mm	HB5090	40		9315330121150
50 x 120mm	HB50120	40		9316101001114
50 x 140mm	HB50140	40		9316101001121
50 x 180mm	HB50180	40		9316101001138
50 x 220mm	HB50220	20		9316101001145

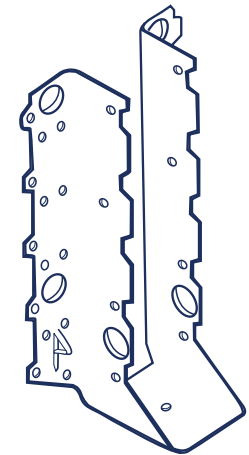

Hangabacket Stainless Steel NEW				
35 x 90mm	HBSS3590	20		9316101051157
35 x 120mm	HBSS35120	20		9316101051164
35 x 140mm	HBSS35140	20		9316101051171
45 x 90mm	HBSS4590	20		9316101051188
45 x 120mm	HBSS45120	20		9316101051195
45 x 140mm	HBSS45140	20		9316101051201
45 x 180mm	HBSS45180	20		9316101051218
45 x 220mm	HBSS45220	20		9316101051225

Heavy Duty Brackets				
49 x 180mm	HD49180	20		9316101001909
60 x 130mm	HD60130	20		9316101001855
60 x 240mm	HD60240	20		9316101001152
65 x 170mm	HD65170	20		9316101004825
70 x 90mm	HD7090	20		9316101001879
70 x 180mm	HD70180	20		9316101001886

Heavy Duty Brackets

PRODUCT NAME	CODE	QTY	WHLSALE	APN CODE
Heavy Duty Brackets				
70 x 200mm	HD70200	20		9316101004832
75 x 220mm	HD75220	20		9316101001176
75 x 280mm	HD75280	20		9316101001183
90 x 90mm	HD9090	20		9316101050907
90 x 140mm	HD90140	20		9316101050891
90 x 200mm	HD90200	20		9316101004849
95 x 165mm	HD95165	20		9316101001893
100 x 270mm	HD100270	20		9316101001190

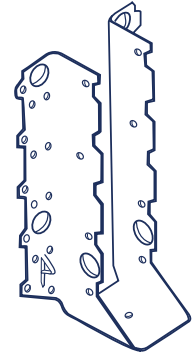

Hyspan & I Beam Brackets

Hyspan Brackets – HY Series – For 45mm & 63mm sections				
48 x 195mm	HY48195	20		9316101002227
48 x 235mm	HY48235	20		9316101002234
48 x 295mm	HY48295	20		9316101002449
65 x 165mm	HY65165	20		9316101001862
65 x 195mm	HY65195	20		9316101001954
65 x 235mm	HY65235	20		9316101002241
65 x 295mm	HY65295	20		9316101002258
65 x 355mm	HY65355	20		9316101002265

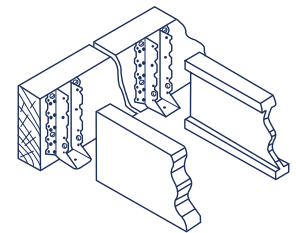

I Beam Brackets – Face Mounted (incl. HJ series Hybeam)				
46 x 235mm	HJ46235	20		081942032694
46 x 286mm	HJ46286	20		081942032670
48 x 195mm	HJ48195	20		9316101001916
48 x 235mm	HJ48235	20		9316101001930
59 x 240mm	HJ59240	20		9316101001947
60 x 355mm	HJ60355	20		081942033332
65 x 295mm	HJ65295	20		9316101001978
65 x 355mm	HJ65355	20		9316101001992
92 x 240mm	HJ92240	20		9316101003590

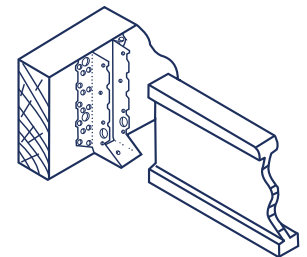

I Beam Brackets – Top Mounted (incl. HJ series Hybeam)				
46 x 241mm	TM46241	25		081942031338
46 x 302mm	TM46302	25		081942012269
48 x 200mm	TM48200	25		9316101003514
48 x 240mm	TM48240	25		9316101003521
58 x 246mm	TM58246	25		9316101003538
60 x 356mm	TM60356	25		081942031352
65 x 301mm	TM65301	25		081942047018
65 x 356mm	TM65356	25		081942041900

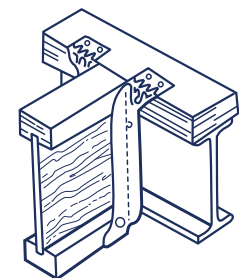

Double I Beam – Face Mounted				
97 x 195mm	HJD200	20		9316101003545
97 x 235mm	HJD240	20		9316101003552
117 x 240mm	HJD246	20		9316101003569
129 x 295mm	HJD300	20		9316101003576

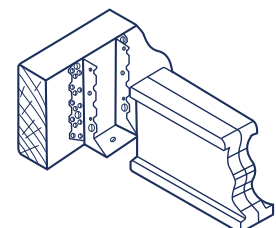

Hooknail

PRODUCT NAME	CODE	QTY	WHL SALE	APN CODE
Hooknail 32 – 4 Series				
33mm wide x 127mm	4R4N	267		9316101004382
33mm wide x 190mm	6R4N	178		9316101004399
33mm wide x 285mm	9R4N	118		9316101004405

Hooknail 32 – 5 Series				
44mm wide x 63mm	2R5N	400		9316101004412
44mm wide x 127mm	4R5N	200		9316101004429
44mm wide x 127mm Trade Pack	4R5NT	100		9316101004436
44mm wide x 190mm	6R5N	133		9316101004443
44mm wide x 190mm Trade Pack	6R5NT	66		9316101004450
44mm wide x 222mm	7R5N	114		9316101004467
44mm wide x 254mm	8R5N	100		9316101004474
44mm wide x 317mm	10R5N	80		9316101004481

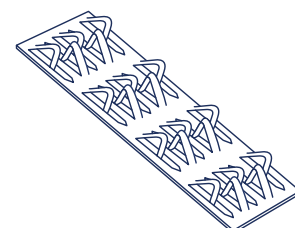

Hooknail 32 – 8 Series				
67mm wide x 63mm	2R8N	266		9316101004498
67mm wide x 127mm	4R8N	133		9316101004504
67mm wide x 127mm Trade Pack	4R8NT	66		9316101004511
67mm wide x 190mm	6R8N	88		9316101004528
67mm wide x 190mm Trade Pack	6R8NT	44		9316101004535
67mm wide x 254mm	8R8N	66		9316101004542

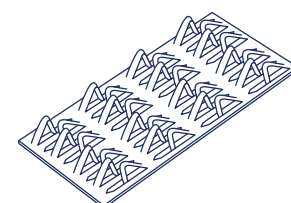

Hooknail 32 – 10 Series				
89mm wide x 63mm	2R10N	200		9316101004559
89mm wide x 127mm	4R10N	100		9316101004566
89mm wide x 127mm Trade Pack	4R10NT	50		9316101004573
89mm wide x 190mm	6R10N	66		9316101004580
89mm wide x 190mm Trade Pack	6R10NT	34		9316101004597
89mm wide x 254mm	8R10N	50		9316101004603
89mm wide x 254mm Trade Pack	8R10NT	26		9316101004610
89mm wide x 317mm	10R10N	40		9316101004627
89mm wide x 380mm	12R10N	33		9316101004634

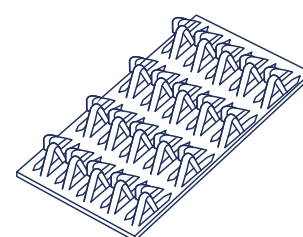

Hooknail 32 – 15 Series				
133mm wide x 63mm	2R15N	133		9316101004641
133mm wide x 127mm	4R15N	66		9316101004658
133mm wide x 190mm	6R15N	44		9316101004665
133mm wide x 254mm	8R15N	33		9316101004672
133mm wide x 317mm	10R15N	27		9316101004689
133mm wide x 380mm	12R15N	22		9316101004696

Bracket Nails

PRODUCT NAME	CODE	QTY	WHLSALE	APN CODE
30 x 2.8 Double Diameter				
Galvanised pack	NG10P	200x10		9316101001220
2kg Tub, Galvanised	NG	2kg		9316101001268
5kg Tub, Galvanised	NG5	5kg		9316101003026
Processed pack	NP10P	200x10		9316101001237
2kg Tub, Processed	NP	2kg		9316101001244
5kg Tub, Processed	NP5	5kg		9316101003033

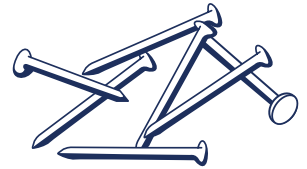

Heavy Duty HYBeam Nails

30 x 3.15 Double Diameter				
Galvanised pack	H'NG10P	200X10		9316101002272
2kg Tub, Galvanised	H'NG	2kg		9316101002302



Groupnail

Groupnail				
25 x 100mm	GN25	300		9316101001312
50 x 100mm (Trade Pack)	GNTP	100		9316101501003
50 x 100mm	GN50	200		9316101001329
75 x 100mm	GN75	150		9316101001336
100 x 100mm	GN100	100		9316101001343

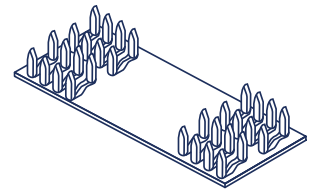

Mininail & Shadetak

Mininail				
25 x 50mm	MN2	500		9316101001350

Shadetak (12 x 50mm)				
Galvanised	STZ	500		9316101025011
Green	STG	500		9316101030015

Shadetak Prepacked				
Galvanised	STPZ	10X50		9316101132504
Green	STPG	10X50		9316101132511

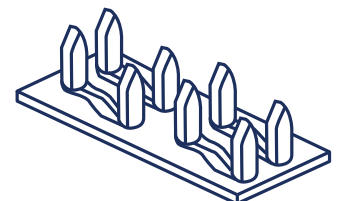
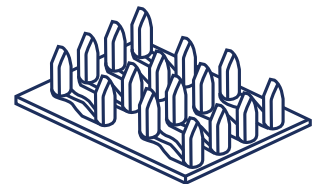

Timber Connectors

PRODUCT NAME	CODE	QTY	WHL SALE	APN CODE
Cyclone Strap				
340mm	CS34	100		9316101002104
400mm	CS40	100		9316101002111
Truss Grip				
110 x 25mm	TSGP	100		9316101004047
Batten Strap				
70mm	BS70	50		9316101050365
75mm	BS75	50		9316101001275
Heavy Duty Joistrap				
31 x 170mm – Left	HDJL	100		9316101002135
31 x 170mm – Right	HDJR	100		9316101002142
Joistrap				
175mm Long	JS150	150		9316101150751
Fascia Bracket				
312 x 50mm – Left	FBL	10		9316101001299
312 x 50mm – Right	FBR	10		9316101050266
Internal Wall Bracket				
Trade pak – Coined 105 x 46 x 38mm	IWB	100		9316101001305
Bearer Plate				
75 x 150 mm	BP	100		9316101001282
Stair Bracket – Galvanised				
50 x 50 x 200mm	STBR	25		9316101004320
Ultra Heavy Duty Angle – Zinc				
40 x 40 x 230mm x 2.55mm thick	UHDA	25		9316101000490
Unibracket				
58mm	UN58	200		9316101001206
100mm	UN100	100		9316101010017
125mm	UN125	100		9316101001213

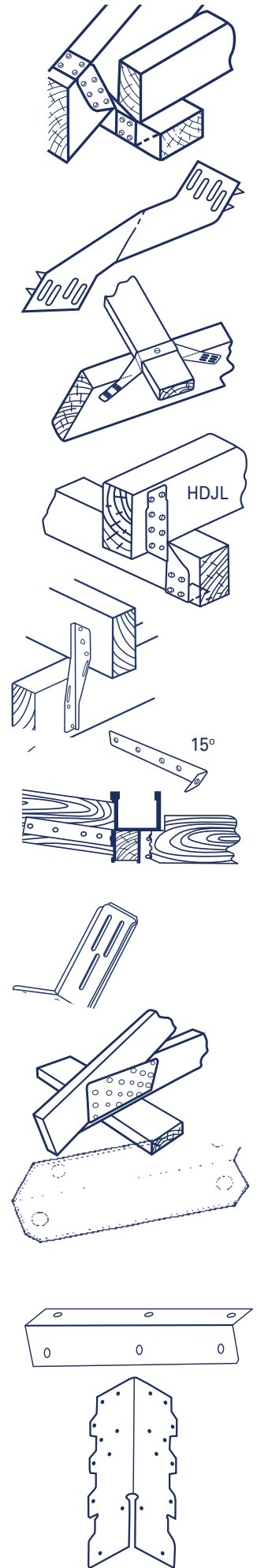

Timber Connectors

PRODUCT NAME	CODE	QTY	WHLSALE	APN CODE
Triple Fix				
Pre-bent Right	TGR	100		9316101331006
Pre-bent Left	TGL	100		9316101771000

Pergola Angle				
88 x 63 x 36 x 1.6mm	PGA	100		9316101886360

Stud Ties				
150 x 90 x 150mm – For 90mm Timber	ST4U90	100		9316101004894
250 x 150 - Single Bend	ST4U	80		9316101050921

Single Sided Stud Ties				
240 x 60mm - Left	SSTL	50		9316101050952
240 x 60mm - Right	SSTR	50		9316101050969

Plate Strap				
75 x 50 x 195 x 30mm	PS	100		9316101050938

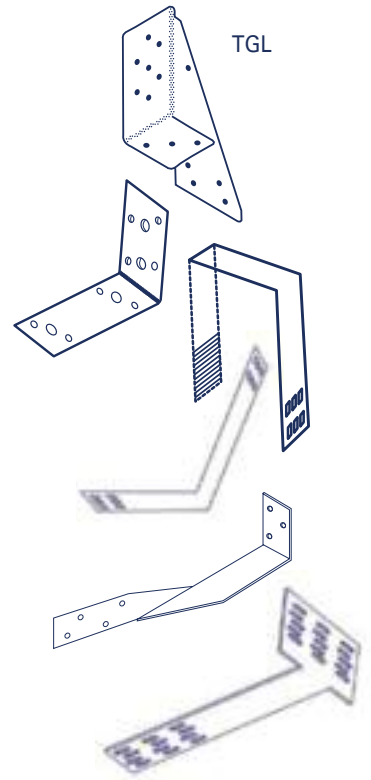

Flexemby (Twin cable)

PRODUCT NAME	CODE	QTY	APN CODE
2000mm Lengths	FXT200	1	9316101001541
2250mm Lengths	FXT225	1	9316101001558
2500mm Lengths	FXT250	1	9316101001565
2750mm Lengths	FXT275	1	9316101001572
3000mm Lengths	FXT300	1	9316101001589
3250mm Lengths	FXT325	1	9316101001596
3500mm Lengths	FXT350	1	9316101001602
3750mm Lengths	FXT375	1	9316101001619
4000mm Lengths	FXT400	1	9316101001626
4250mm Lengths	FXT425	1	9316101001633
4500mm Lengths	FXT450	1	9316101001640
4750mm Lengths	FXT475	1	9316101001657
5000mm Lengths	FXT500	1	9316101001664
5250mm Lengths	FXT525	1	9316101001671
5500mm Lengths	FXT550	1	9316101001688
5750mm Lengths	FXT575	1	9316101001695
6000mm Lengths	FXT600	1	9316101001701
6250mm Lengths	FXT625	1	9316101001718
6500mm Lengths	FXT650	1	9316101001725
6750mm Lengths	FXT675	1	9316101001732
7000mm Lengths	FXT700	1	9316101001749
7250mm Lengths	FXT725	1	9316101001756
7500mm Lengths	FXT750	1	9316101001763
7750mm Lengths	FXT775	1	9316101001770
8000mm Lengths	FXT800	1	9316101001787
Additional fulcrum	ADF1	1	9316101001794

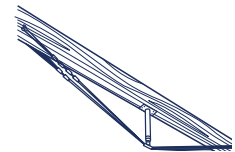

Holistrap

PRODUCT NAME	CODE	QTY	WHLSALE	APN CODE
Holistrap – 25mm x 0.6mm				
6m Punched	HS/ST6	1		9316101256064
15m Punched	HS/ST15	1		9316101251564
30m Punched	HS/ST30	1		9316101253063
50m Punched	HS/ST50	1		9316101255067

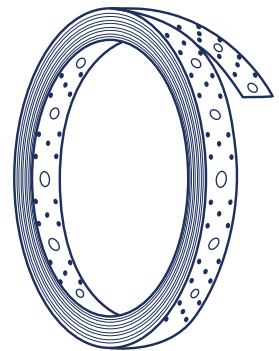

Holistrap – 25mm x 0.8mm				
6m Punched	HS/HD6	1		9316101256088
15m Punched	HS/HD15	1		9316101251588
30m Punched	HS/HD30	1		9316101253087
50m Punched	HS/HD50	1		9316101255081

Holistrap – 30mm x 0.8mm				
6m Punched	HS30/6	1		9316101306080
15m Punched	HS30/15	1		9316101301580
30m Punched	HS30/30	1		9316101303089
50m Punched	HS30/50	1		9316101305083

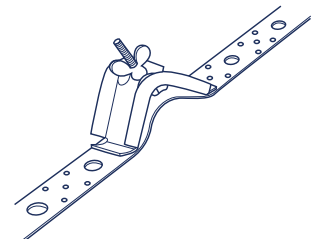

Holistrap – 30mm x 1.0mm				
6m Punched	HS30/HD6	1		9316101306103
15m Punched	HS30/HD15	1		9316101301511
30m Punched	HS30/HD30	1		9316101303010
50m Punched	HS30/HD50	1		9316101305014

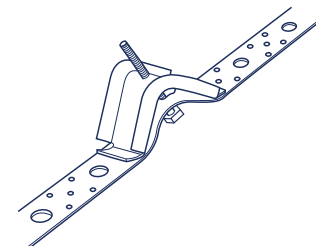

Holistrap – 32mm x 1.2mm				
30m Punched	HS32/30	1		9316101050914

Holistrap Tensioners				
Holistrap Tensioners	HT	30		9316101176102
Holistrap Tensioners - Bolt Fastened	HTB	30		9316101050853

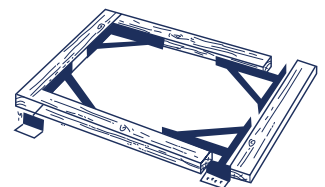

No Sag Easy Gate

Bracket Kit	NOSAG	1		066890800014
-------------	-------	---	--	--------------

Steel Gate Frame Kit

Steel Gate Frame	SGFR	1		9314453920015
Expansion Kit	SGEX	1		9314453920053

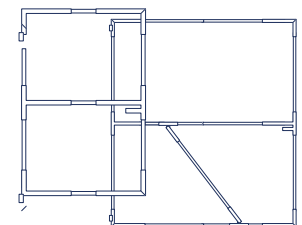

Safety Barrier Mesh, Orange

Safety Barrier Mesh – 1m x 50m roll	SBM	1		9316101003866
-------------------------------------	-----	---	--	---------------



Vents

Slim: 230 x 75	SLV	20		9316101001510
Slim: (230 x 88) Louvred	VSL	20		9316101001527
High: (230 x 168) Louvred	VHL	20		9316101001534
Fire Proof: 230 x 75	SLVFP	20		9316101002005
Fire Proof: (230 x 168) Louvred	VHLFP	20		9316101051089

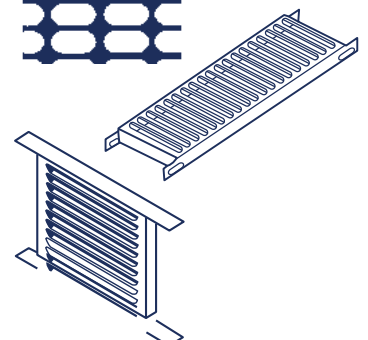

Insulation Foil & Weatherproof Wrap

PRODUCT NAME	CODE	QTY	WHLSALE	APN CODE
Weatherproof Wrap				
Weatherproof wrap – 1,350 x 30m roll	WPW3	1		9329496000174
Weatherproof wrap – 1,350 x 60m roll	WPW6	1		9329496000167
Weatherproof Wrap – BREATHER				
Weatherproof wrap – 1,350 x 30m roll	WPB3	1		9329496000242
Weatherproof wrap – 1,350 x 60m roll	WPB6	1		9329496000235

Damp Cor

Damp Cor – Polythene Dampcourse Flashing				
110mm wide x 500um x 30m	PDF110	1		9316101050075
150mm wide x 500um x 30m	PDF150	1		9316101050082
230mm wide x 500um x 30m	PDF230	1		9316101050099
300mm wide x 500um x 30m	PDF300	1		9316101050105
380mm wide x 500um x 30m	PDF380	1		9316101050112
450mm wide x 500um x 30m	PDF450	1		9316101050228

Bitumen Malthoid - Dampcourse

110mm wide x 20mt	MAL110	1		9316101050976
150mm wide x 20mt	MAL150	1		9316101050983

Alcor - 0.3mm Bitumen Coated Aluminum

230mm wide x 10mt	ALC230	1		9316101050990
300mm wide x 10mt	ALC300	1		9316101051003

Exfoam

Exfoam – Polyethylene Expansion Foam				
75mm wide x 10mm x 25m	EXF75	1		9316101050310
100mm wide x 10mm x 25m	EXF100	1		9316101050327
125mm wide x 10mm x 25m	EXF125	1		9316101050334
150mm wide x 10mm x 25m	EXF150	1		9316101050341

Exfoam – Adhesive Polyethylene Expansion Foam				
75mm wide x 10mm x 25m	EXFA75	1		9316101050808
100mm wide x 10mm x 25m	EXFA100	1		9316101050815
125mm wide x 10mm x 25m	EXFA125	1		9316101050822
150mm wide x 10mm x 25m	EXFA150	1		9316101050839

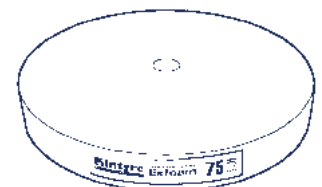
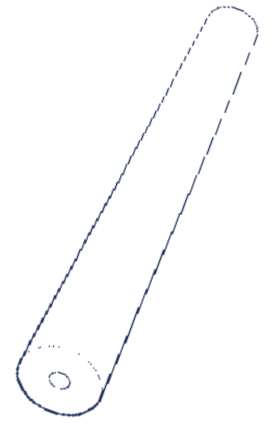

Sisaltak

PRODUCT NAME	CODE	QTY	WHLSALE	APN CODE
Sisaltak				
50 strips of 10 – 23 x 25mm 4 pin	ST500	500		

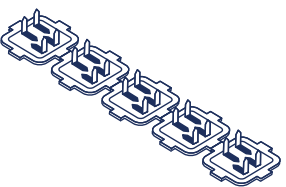

Ant Caps

Ant Caps (Small)				
100mm Plain	ANP	100		9316101001435
100mm with hole	ANA	100		9316101001442
110mm 22mm side/slot & hole	ANS	100		9316101000537

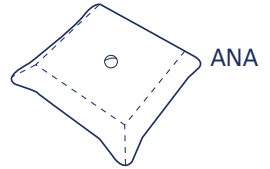

Ant Caps (Large)				
100mm 50mm side	ANP/50	50		9316101001459
100mm 50mm side & hole	ANA/50	50		9316101001466
100mm 50mm side/slot & hole	ANS/50	50		9316101003729
120mm 50mm side & hole	AN12	50		9316101001473
120mm 50mm side	ANP12	50		9316101003736
225mm Half	ANH25	50		9316101001480
225mm Half, 50mm side	ANH50	50		9316101002159
225mm 25mm side & hole	AN2/25	50		9316101001497
225mm 50mm side & hole	AN2/50	50		9316101001503
225mm 50mm side	ANP2/50	50		9316101002470

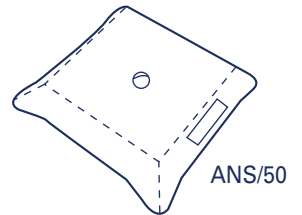

Brick Ties

Slim with Nails (100mm)	BTSL	150		9316101181359
Slim with Screws (100mm)	BTSL/S	150		9316101050198
Slim Stainless with S/S Nails (100mm)	SLST	150		9316101001374
Slim Stainless with S/S Screws (100mm)	SLST/S	150		9316101050129
Standard (100mm)	BTST	150		9316101251359
Standard with Nails (100mm)	BTST/N	150		9316101050303
Frame tie (230mm)	BTFT	75		9316101230750
Slim Cavity Ties (galv) (185mm)	SLCT	250		9316101001398
Slim Cavity Ties (SS) (185mm)	SLCTS	250		9316101001404

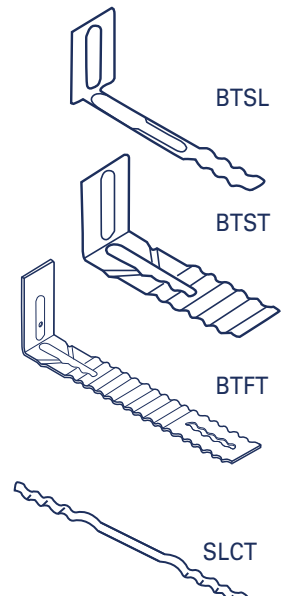

Expansion Ties

Expansion Ties (galv)	EXTG	20		9316101001411
Expansion Ties (ss)	EXTSS	20		9316101001428

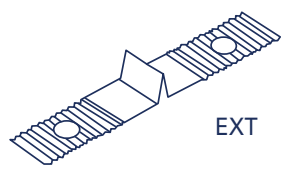

Double Sleeve Expansion Ties				
Double Sleeve Exp Ties (galv w plastic slides)	CGT 1-P	50		9316101000568
Double Sleeve Exp Ties (stainless w plastic slides)	CGT 1-P SS	50		9316101000551
Double Sleeve Exp Ties (galv w galv slides)	CGT 1	50		9316101050297
Right Angle Dble Slve Exp Ties (galv w galv slides)	CGT 1-B	50		9316101050280

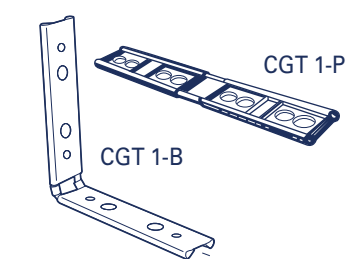

Wire Ties

Red/Galvanised Wire Ties				
Double Ring Cavity 180mm x 3.15mm	WTSL31R	10x50		9316035065978
Masonry Cavity 190mm x 3.15mm	WTB31R	5x50		9316035065909
Masonry Cavity 230mm x 4.0mm	WTHB40R	5x25		9316035065916

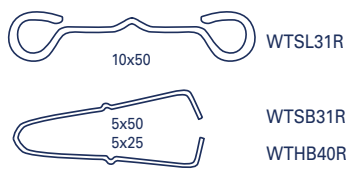

Metal Door Frames • Wholesale price is the same for both Assembled & Unassembled

PRODUCT NAME	CODE	WHLSALE
B93 Profile Unassembled (2055 Reveal Height)		
524 Single Left Hand 3 Hinge	B93524L3HU	
524 Single Right Hand 3 Hinge	B93524R3HU	
624 Single Left Hand 3 Hinge	B93624L3HU	
624 Single Right Hand 3 Hinge	B93624R3HU	
724 Single Left Hand 3 Hinge	B93724L3HU	
724 Single Right Hand 3 Hinge	B93724R3HU	
774 Single Left Hand 3 Hinge	B93774L3HU	
774 Single Right Hand 3 Hinge	B93774R3HU	
824 Single Left Hand 3 Hinge	B93824L3HU	
824 Single Right Hand 3 Hinge	B93824R3HU	
874 Single Left Hand 3 Hinge	B93874L3HU	
874 Single Right Hand 3 Hinge	B93874R3HU	
924 Single Left Hand 3 Hinge	B93924L3HU	
924 Single Right Hand 3 Hinge	B93924R3HU	
1024 Single Left Hand 3 Hinge	B931024L3HU	
1024 Single Right Hand 3 Hinge	B931024R3HU	
1074 Single Left Hand 3 Hinge	B931074L3HU	
1074 Single Right Hand 3 Hinge	B931074R3HU	
1246 Double 6 Hinge	B9312466HU	
1446 Double 6 Hinge	B9314466HU	
1546 Double 6 Hinge	B9315466HU	
1646 Double 6 Hinge	B9316466HU	
1746 Double 6 Hinge	B9317466HU	
1846 Double 6 Hinge	B9318466HU	
2046 Double 6 Hinge	B9320466HU	

PRODUCT NAME	CODE	WHLSALE
B102 Profile Unassembled (2055 Reveal Height)		
524 Single Left Hand 3 Hinge	B102524L3HU	
524 Single Right Hand 3 Hinge	B102524R3HU	
624 Single Left Hand 3 Hinge	B102624L3HU	
624 Single Right Hand 3 Hinge	B102624R3HU	
724 Single Left Hand 3 Hinge	B102724L3HU	
724 Single Right Hand 3 Hinge	B102724R3HU	
774 Single Left Hand 3 Hinge	B102774L3HU	
774 Single Right Hand 3 Hinge	B102774R3HU	
824 Single Left Hand 3 Hinge	B102824L3HU	
824 Single Right Hand 3 Hinge	B102824R3HU	
874 Single Left Hand 3 Hinge	B102874L3HU	
874 Single Right Hand 3 Hinge	B102874R3HU	
924 Single Left Hand 3 Hinge	B102924L3HU	
924 Single Right Hand 3 Hinge	B102924R3HU	
1024 Single Left Hand 3 Hinge	B1021024L3HU	
1024 Single Right Hand 3 Hinge	B1021024R3HU	
1074 Single Left Hand 3 Hinge	B1021074L3HU	
1074 Single Right Hand 3 Hinge	B1021074R3HU	
1246 Double 6 Hinge	B10212466HU	
1446 Double 6 Hinge	B10214466HU	
1546 Double 6 Hinge	B10215466HU	
1646 Double 6 Hinge	B10216466HU	
1746 Double 6 Hinge	B10217466HU	
1846 Double 6 Hinge	B10218466HU	
2046 Double 6 Hinge	B10220466HU	

PRODUCT NAME	CODE	WHLSALE
B114 Profile Unassembled (2055 Reveal Height)		
524 Single Left Hand 2 Hinge	B114524L2HU	
524 Single Right Hand 2 Hinge	B114524R2HU	
624 Single Left Hand 2 Hinge	B114624L2HU	
624 Single Right Hand 2 Hinge	B114624R2HU	
724 Single Left Hand 3 Hinge	B114724L3HU	
724 Single Right Hand 3 Hinge	B114724R3HU	
774 Single Left Hand 3 Hinge	B114774L3HU	
774 Single Right Hand 3 Hinge	B114774R3HU	
824 Single Left Hand 3 Hinge	B114824L3HU	
824 Single Right Hand 3 Hinge	B114824R3HU	
874 Single Left Hand 3 Hinge	B114874L3HU	
874 Single Right Hand 3 Hinge	B114874R3HU	
924 Single Left Hand 3 Hinge	B114924L3HU	
924 Single Right Hand 3 Hinge	B114924R3HU	
1024 Single Left Hand 3 Hinge	B1141024L3HU	
1024 Single Right Hand 3 Hinge	B1141024R3HU	
1074 Single Left Hand 3 Hinge	B1141074L3HU	
1074 Single Right Hand 3 Hinge	B1141074R3HU	
1246 Double 6 Hinge	B11412466HU	
1446 Double 6 Hinge	B11414466HU	
1546 Double 6 Hinge	B11415466HU	
1646 Double 6 Hinge	B11416466HU	
1746 Double 6 Hinge	B11417466HU	
1846 Double 6 Hinge	B11418466HU	
2046 Double 6 Hinge	B11420466HU	

PRODUCT NAME	CODE	WHLSALE
B114 Profile Unassembled (2355 Reveal Height)		
524 Single Left Hand 3 Hinge	B114524L3HUS1	
524 Single Right Hand 3 Hinge	B114524R3HUS1	
624 Single Left Hand 3 Hinge	B114624L3HUS1	
624 Single Right Hand 3 Hinge	B114624R3HUS1	
724 Single Left Hand 3 Hinge	B114724L3HUS1	
724 Single Right Hand 3 Hinge	B114724R3HUS1	
774 Single Left Hand 3 Hinge	B114774L3HUS1	
774 Single Right Hand 3 Hinge	B114774R3HUS1	
824 Single Left Hand 3 Hinge	B114824L3HUS1	
824 Single Right Hand 3 Hinge	B114824R3HUS1	
874 Single Left Hand 3 Hinge	B114874L3HUS1	
874 Single Right Hand 3 Hinge	B114874R3HUS1	
924 Single Left Hand 3 Hinge	B114924L3HUS1	
924 Single Right Hand 3 Hinge	B114924R3HUS1	
1024 Single Left Hand 3 Hinge	B1141024L3HUS1	
1024 Single Right Hand 3 Hinge	B1141024R3HUS1	
1074 Single Left Hand 3 Hinge	B1141074L3HUS1	
1074 Single Right Hand 3 Hinge	B1141074R3HUS1	
1246 Double 6 Hinge	B11412466HUS1	
1446 Double 6 Hinge	B11414466HUS1	
1546 Double 6 Hinge	B11415466HUS1	
1646 Double 6 Hinge	B11416466HUS1	
1746 Double 6 Hinge	B11417466HUS1	
1846 Double 6 Hinge	B11418466HUS1	
2046 Double 6 Hinge	B11420466HUS1	

Metal Door Frames

PRODUCT NAME	CODE	WHLSALE
B123 Profile Unassembled (2055 Reveal Height)		
524 Single Left Hand 3 Hinge	B123524L3HU	
524 Single Right Hand 3 Hinge	B123524R3HU	
624 Single Left Hand 3 Hinge	B123624L3HU	
624 Single Right Hand 3 Hinge	B123624R3HU	
724 Single Left Hand 3 Hinge	B123724L3HU	
724 Single Right Hand 3 Hinge	B123724R3HU	
774 Single Left Hand 3 Hinge	B123774L3HU	
774 Single Right Hand 3 Hinge	B123774R3HU	
824 Single Left Hand 3 Hinge	B123824L3HU	
824 Single Right Hand 3 Hinge	B123824R3HU	
874 Single Left Hand 3 Hinge	B123874L3HU	
874 Single Right Hand 3 Hinge	B123874R3HU	
924 Single Left Hand 3 Hinge	B123924L3HU	
924 Single Right Hand 3 Hinge	B123924R3HU	
1024 Single Left Hand 3 Hinge	B1231024L3HU	
1024 Single Right Hand 3 Hinge	B1231024R3HU	
1074 Single Left Hand 3 Hinge	B1231074L3HU	
1074 Single Right Hand 3 Hinge	B1231074R3HU	
1246 Double 6 Hinge	B12312466HU	
1446 Double 6 Hinge	B12314466HU	
1546 Double 6 Hinge	B12315466HU	
1646 Double 6 Hinge	B12316466HU	
1746 Double 6 Hinge	B12317466HU	
1846 Double 6 Hinge	B12318466HU	
2046 Double 6 Hinge	B12320466HU	

PRODUCT NAME	CODE	WHLSALE
B146 Profile Unassembled (2055 Reveal Height)		
524 Single Left Hand 3 Hinge	B146524L3HU	
524 Single Right Hand 3 Hinge	B146524R3HU	
624 Single Left Hand 3 Hinge	B146624L3HU	
624 Single Right Hand 3 Hinge	B146624R3HU	
724 Single Left Hand 3 Hinge	B146724L3HU	
724 Single Right Hand 3 Hinge	B146724R3HU	
774 Single Left Hand 3 Hinge	B146774L3HU	
774 Single Right Hand 3 Hinge	B146774R3HU	
824 Single Left Hand 3 Hinge	B146824L3HU	
824 Single Right Hand 3 Hinge	B146824R3HU	
874 Single Left Hand 3 Hinge	B146874L3HU	
874 Single Right Hand 3 Hinge	B146874R3HU	
924 Single Left Hand 3 Hinge	B146924L3HU	
924 Single Right Hand 3 Hinge	B146924R3HU	
1024 Single Left Hand 3 Hinge	B1461024L3HU	
1024 Single Right Hand 3 Hinge	B1461024R3HU	
1074 Single Left Hand 3 Hinge	B1461074L3HU	
1074 Single Right Hand 3 Hinge	B1461074R3HU	
1246 Double 6 Hinge	B14612466HU	
1446 Double 6 Hinge	B14614466HU	
1546 Double 6 Hinge	B14615466HU	
1646 Double 6 Hinge	B14616466HU	
1746 Double 6 Hinge	B14617466HU	
1846 Double 6 Hinge	B14618466HU	
2046 Double 6 Hinge	B14620466HU	

PRODUCT NAME	CODE	WHLSALE
B194 Profile Unassembled (2055 Reveal Height)		
524 Single Left Hand 3 Hinge	B194524L3HU	
524 Single Right Hand 3 Hinge	B194524R3HU	
624 Single Left Hand 3 Hinge	B194624L3HU	
624 Single Right Hand 3 Hinge	B194624R3HU	
724 Single Left Hand 3 Hinge	B194724L3HU	
724 Single Right Hand 3 Hinge	B194724R3HU	
774 Single Left Hand 3 Hinge	B194774L3HU	
774 Single Right Hand 3 Hinge	B194774R3HU	
824 Single Left Hand 3 Hinge	B194824L3HU	
824 Single Right Hand 3 Hinge	B194824R3HU	
874 Single Left Hand 3 Hinge	B194874L3HU	
874 Single Right Hand 3 Hinge	B194874R3HU	
924 Single Left Hand 3 Hinge	B194924L3HU	
924 Single Right Hand 3 Hinge	B194924R3HU	
1024 Single Left Hand 3 Hinge	B1941024L3HU	
1024 Single Right Hand 3 Hinge	B1941024R3HU	
1074 Single Left Hand 3 Hinge	B1941074L3HU	
1074 Single Right Hand 3 Hinge	B1941074R3HU	
1246 Double 6 Hinge	B19412466HU	
1446 Double 6 Hinge	B19414466HU	
1546 Double 6 Hinge	B19415466HU	
1646 Double 6 Hinge	B19416466HU	
1746 Double 6 Hinge	B19417466HU	
1846 Double 6 Hinge	B19418466HU	
2046 Double 6 Hinge	B19420466HU	

PRODUCT NAME	CODE	WHLSALE
B230 Profile Unassembled (2055 Reveal Height)		
524 Single Left Hand 3 Hinge	B230524L3HU	
524 Single Right Hand 3 Hinge	B230524R3HU	
624 Single Left Hand 3 Hinge	B230624L3HU	
624 Single Right Hand 3 Hinge	B230624R3HU	
724 Single Left Hand 3 Hinge	B230724L3HU	
724 Single Right Hand 3 Hinge	B230724R3HU	
774 Single Left Hand 3 Hinge	B230774L3HU	
774 Single Right Hand 3 Hinge	B230774R3HU	
824 Single Left Hand 3 Hinge	B230824L3HU	
824 Single Right Hand 3 Hinge	B230824R3HU	
874 Single Left Hand 3 Hinge	B230874L3HU	
874 Single Right Hand 3 Hinge	B230874R3HU	
924 Single Left Hand 3 Hinge	B230924L3HU	
924 Single Right Hand 3 Hinge	B230924R3HU	
1024 Single Left Hand 3 Hinge	B2301024L3HU	
1024 Single Right Hand 3 Hinge	B2301024R3HU	
1074 Single Left Hand 3 Hinge	B2301074L3HU	
1074 Single Right Hand 3 Hinge	B2301074R3HU	
1246 Double 6 Hinge	B23012466HU	
1446 Double 6 Hinge	B23014466HU	
1546 Double 6 Hinge	B23015466HU	
1646 Double 6 Hinge	B23016466HU	
1746 Double 6 Hinge	B23017466HU	
1846 Double 6 Hinge	B23018466HU	
2046 Double 6 Hinge	B23020466HU	

Metal Door Frames

PRODUCT NAME	CODE	WHLSALE
Stud Fix Brackets (16 per pk) - Available in 10, 13 or 16mm	STB	
Welded Mitre Join	WM	
Dynabolt option - For fixing to existing brickwork or concrete	D/bolt	
Screw Prep Option - For fixing to stud work	SP	

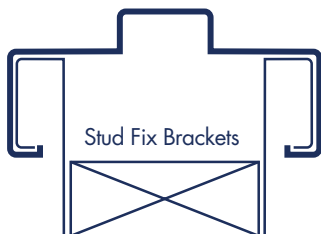
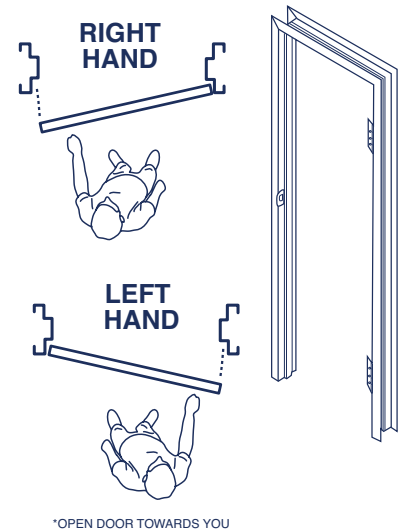
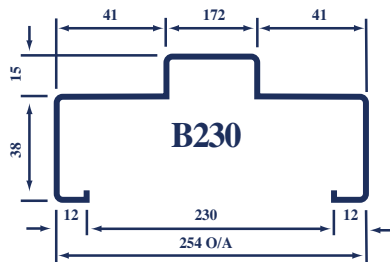
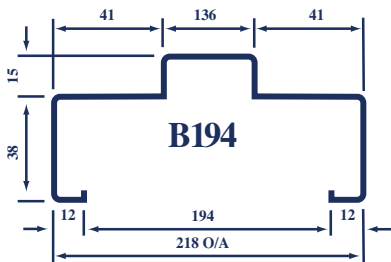
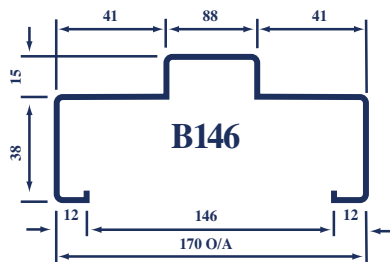
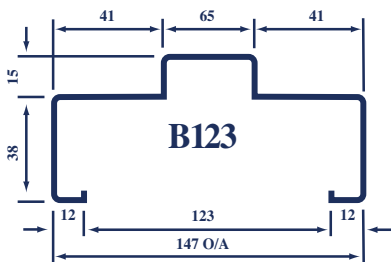
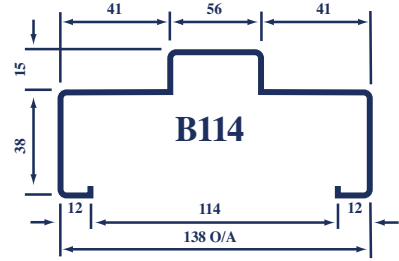
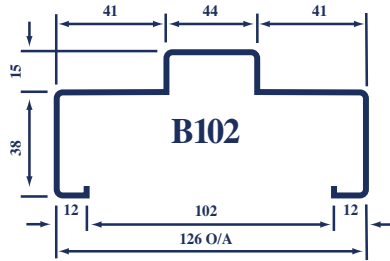
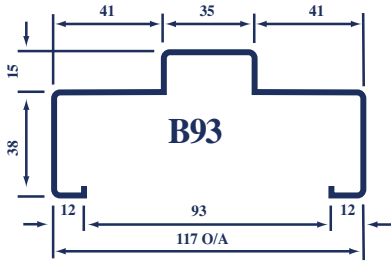

'Special' frames quoted on request

McIntyre frames are made from zincanneal material

Fire rated and metal clad doors available on request

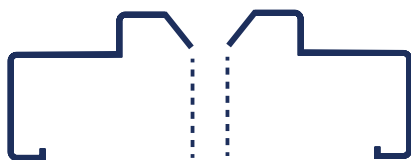

D/Bolt



Strat Fix

Sub Floor Access Doors

PRODUCT NAME	CODE	QTY	WHLSALE	APN CODE
Access Doors with Painted Frames				
725mm wide x 434mm high	ACD434	1		9316101003422
725mm wide x 520mm high	ACD520	1		9316101003439
725mm wide x 692mm high	ACD692	1		9316101003446
725mm wide x 863mm high	ACD863	1		9316101003453
725mm wide x 1292mm high	ACD1292	1		9316101003460

Access Doors with Galvanised Frames				
725mm wide x 434mm high	ACD434G	1		9316101003477
725mm wide x 520mm high	ACD520G	1		9316101003484
725mm wide x 692mm high	ACD692G	1		9316101003491
725mm wide x 863mm high	ACD863G	1		9316101003507
725mm wide x 1292mm high	ACD1292G	1		9316101003095

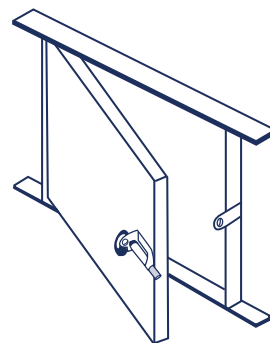

Multi Purpose Brackets – Zinc

Fencing Bracket – M6 Holes				
100 x 40 x 32 x 3mm	MFO082	50		9316101003903

Fence Plates – M8 Holes				
85 x 32 x 3mm – 2 Holes	MFO079	50		9316101003880
140 x 32 x 3mm – 3 Holes	MFO080	50		9316101003897

Corner Bracket – M8 Holes				
72 x 72 x 32 x 3mm	MFO081	50		9316101003682

Shelf Angle Bracket – M6 Holes (x4)				
100 x 75 x 20 x 5mm	MFO223	10		9316101003705
125 x 100 x 20 x 5mm	MFO224	10		9316101003712
150 x 125 x 20 x 5mm	MFO225	10		9316101003972
200 x 150 x 20 x 5mm	MFO226	10		9316101003163
250 x 200 x 20 x 5mm	MFO227	10		9316101003170

Angle Bracket – M6 Holes (x4)				
40 x 40 x 40 x 3mm	MFO228	50		9316101003118
50 x 50 x 40 x 3mm	MFO229	50		9316101003125
75 x 75 x 40 x 3mm (Light use)	MFO230	50		9316101050006
100 x 100 x 40 x 3mm	MFO231	50		9316101003088
50 x 50 x 40 x 5mm	MFO232	50		9316101003132
75 x 75 x 40 x 5mm	MFO233	50		9316101003149
100 x 100 x 40 x 6mm	MFO234	50		9316101003156
150 x 150 x 40 x 5mm	MFO235	50		9316101003651
200 x 200 x 40 x 5mm	MFO236	50		9316101003688

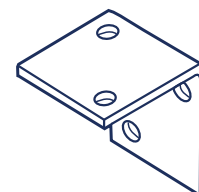
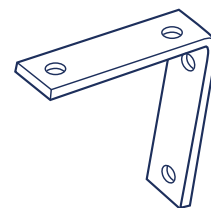
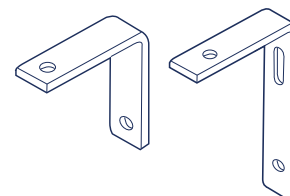
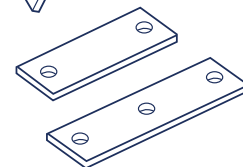
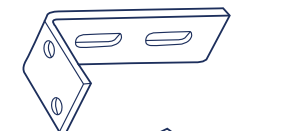

Multi Purpose Brackets – Zinc

PRODUCT NAME	CODE	QTY	WHLSALE	APN CODE
Angle Bracket (x4)				
100 x 75 x 6mm (8mm holes)	MFO083	10		9316101003927
75 x 75 x 6mm (10mm holes)	MFO084	10		9316101003675

Timber Angle Bracket M18 Holes NEW				
100 x 100 x 200 x 8mm (x 6 Holes) Painted	MTA118P	1		9316101051232
101 x 100 x 200 x 8mm (x 6 Holes) Painted	MTA116P	1		

Angle Bracket – M8 Holes (x2)				
45 x 45 x 32 x 3mm	MFO094	50		9316101003910

Angle Bracket with Stay – M6 Holes (x4)				
200 x 200 x 25 x 5mm	MFO214	10		9316101003187
250 x 200 x 25 x 5mm	MFO215	10		9316101003194
250 x 250 x 25 x 5mm	MFO216	10		9316101003200
300 x 200 x 25 x 5mm	MFO217	10		9316101003217
300 x 300 x 25 x 5mm	MFO218	10		9316101003224
350 x 250 x 25 x 5mm	MFO219	10		9316101003965
350 x 350 x 25 x 5mm	MFO220	10		9316101003231
400 x 250 x 25 x 5mm	MFO221	10		9316101003248
500 x 400 x 25 x 5mm	MFO222	10		9316101003255

Multi Purpose Bracket Range – Galvanised

Fence Plinth Bracket – M6 Holes (x4)				
120 x 35 x 35 x 1mm	FPBG	100		9316101050020

Fence Rail Bracket – M6 Holes (x5)				
111 x 60 x 65 x 35 x 2mm	FRBG	100		9316101050037

Angle Bracket – (x2 holes)				
40 x 40 x 40 x 5mm - 10mm Holes	MFO212G	50		9316101004054
40 x 40 x 40 x 5mm - 12mm Holes	MFO200G	50		9316101004061
50 x 50 x 50 x 5mm - 10mm Holes	MFO213G	50		9316101004337
50 x 50 x 50 x 5mm - 12mm Holes	MFO201G	50		9316101004078
65 x 65 x 65 x 5mm - 12mm Holes	MFO202G	50		9316101004085
90 x 90 x 75 x 6mm - 12mm Holes	MFO203G	10		9316101004108
100 x 100 x 50 x 8mm - 14mm Holes	MFO118G	10		9316101051072

Angle Bracket – M12 holes (x 3)				
40 x 80 x 40 x 5mm	MFO204G	50		9316101050488
50 x 100 x 50 x 5mm	MFO205G	50		9316101003934
65 x 130 x 65 x 5mm	MFO206G	25		9316101003941
90 x 150 x 75 x 6mm	MFO207G	10		9316101003958

Angle Bracket – M12 holes (x 4)				
80 x 80 x 40 x 5mm	MFO208G	50		9316101004092
100 x 100 x 50 x 5mm	MFO209G	50		9316101004115
130 x 130 x 65 x 5mm	MFO210G	10		9316101004122
150 x 150 x 75 x 6mm	MFO211G	10		9316101003101

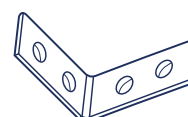
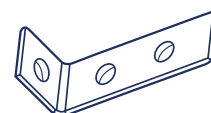
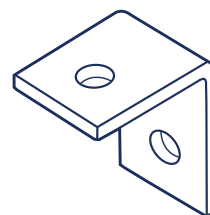
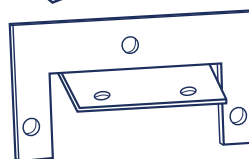
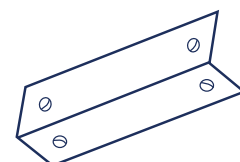
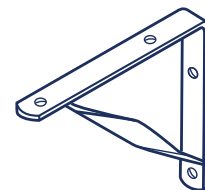
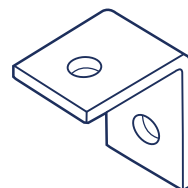
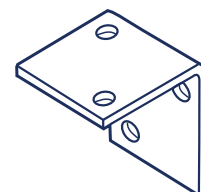

Multi Purpose Bracket Range – Galvanised

PRODUCT NAME	CODE	QTY	WHLSALE	APN CODE
Angle Bracket – M10 holes (x4)				
80 x 80 x 40 x 5mm	MFO20841G	50		9316101050846
100 x 100 x 50 x 5mm	MFO20941G	50		9316101050495
150 x 150 x 75 x 6mm	MFO21141G	20		9316101050501

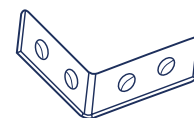

Purlin C100 Angle Bracket – M10 Holes (x6)				
106 x 65 x 52 x 3mm	MFA100G	50		9316101003262

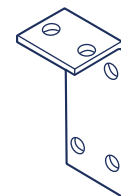

Purlin P100 Angle Bracket Plate – M10 Holes (x2)				
95 x 51 x 3mm	MFP100G	50		9316101003279

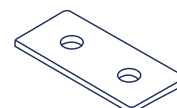

Purlin C150 Angle Bracket – M10 Holes (x4)				
145 x 50 x 50 x 3mm	MFA150G	50		9316101050013

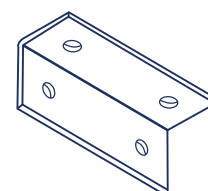

Purlin P150 Angle Bracket Plate – M10 Holes (x2)				
145 x 49 x 3mm	MFP150G	50		9316101003309

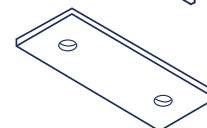

Purlin C200 Angle Bracket – M10 Holes (x4)				
195 x 65 x 65 x 3mm	MFA200G	25		9316101004030

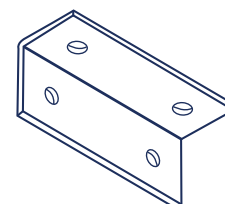

Purlin P200 Angle Bracket Plate – M10 Holes (x2)				
192 x 65 x 3mm	MFP200G	50		9316101003316

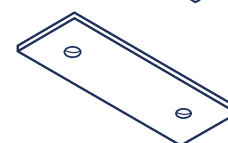

Bond Beam Truss Bracket (x2 holes)				
200 x 50 x 6mm (14 & 17mm holes)	MBB2001417G	25		9316101003323
250 x 50 x 6mm (14 & 17mm holes)	MBB2501417G	25		9316101003330
200 x 50 x 6mm (17mm holes)	MBB2001717G	25		9316101003347
250 x 50 x 6mm (17mm holes)	MBB2501717G	25		9316101003354
200 x 50 x 6mm (17 & 19mm holes)	MBB2001719G	25		9316101003361
250 x 50 x 6mm (17 & 19mm holes)	MBB2501719G	25		9316101003378
200 x 50 x 6mm (14 & 19mm holes)	MBB2001419G	25		9316101003385

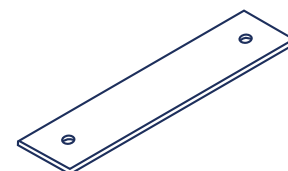

Steel Post Inner Bracket – M10 Holes (x4)				
45 x 42 x 45 x 3mm – M10 Holes (x1)	MFPS50G	50		9316101003392
60 x 45 x 60 x 3mm – M10 Holes (x1)	MFPS65G	50		9316101003408
70 x 45 x 70 x 3mm – M10 Holes (x1)	MFPS75G	50		9316101003415
85 x 80 x 85 x 3mm – M10 Holes (x4)	MFPS90G	50		9316101002289

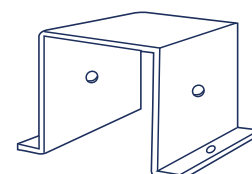
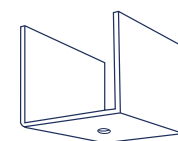

Multi Purpose Bracket Range – Galvanised

PRODUCT NAME	CODE	QTY	WHLSALE	APN CODE
Angle Bracket – M6 holes (x4)				
50 x 50 x 40 x 5mm	MFO232G	50		9316101050433
75 x 75 x 40 x 5mm	MFO233G	50		9316101050440
100 x 100 x 40 x 5mm	MFO234G	50		9316101050457
150 x 150 x 40 x 5mm	MFO235G	25		9316101050464
200 x 200 x 40 x 5mm	MFO236G	25		9316101050471

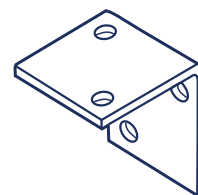

Timber Angle Brkt – M12 holes (x4)				
125 x 65 x 65 x 6mm	MTA125G	20		9316101050518

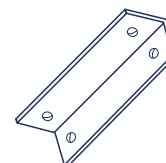

Timber Angle Brkt – M18 holes (x6) NEW				
100 x 100 x 200 x 8mm	MTA118G	5		9316101051140

Timber Angle Brkt – M12 holes (x8)				
190 x 75 x 50 x 6mm	MTA190G	10		9316101050525
240 x 75 x 50 x 6mm	MTA240G	10		9316101050532
290 x 75 x 50 x 6mm	MTA290G	10		9316101050549
240 x 100 x 100 x 10mm (M14 holes)	MTA110G	5		9316101051096

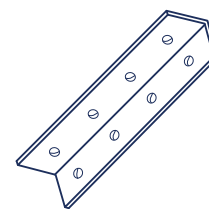

Flat Timber Brkt – M6 holes				
100 x 50 x 3mm	MFT1503G	50		9316101050556
200 x 50 x 3mm	MFT2503G	50		9316101050563
300 x 50 x 5mm	MFT3505G	25		9316101050570

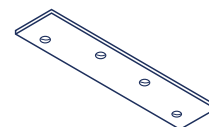

Flat Timber Brkt – M12 holes				
150 x 75 x 5mm	MFT1755G	25		9316101050587

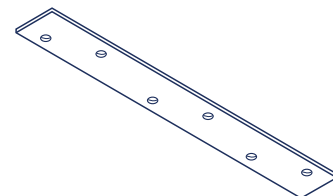

Shelf Angle Brkt – M6 holes (x 4)				
100 x 75 x 20 x 5mm	MFO223G	10		9316101050594
125 x 100 x 20 x 5mm	MFO224G	10		9316101050600
150 x 125 x 20 x 5mm	MFO225G	10		9316101050617
200 x 150 x 20 x 5mm	MFO226G	10		9316101050624
250 x 200 x 20 x 5mm	MFO227G	10		9316101050631

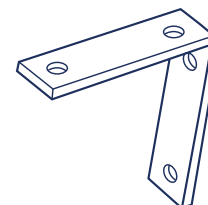

Shelf Angle Brkt w Stay – M6 holes (x4)				
200 x 200 x 25 x 5mm	MFO214G	10		9316101050648
250 x 200 x 25 x 5mm	MFO215G	10		9316101050655
250 x 250 x 25 x 5mm	MFO216G	10		9316101050662
300 x 200 x 25 x 5mm	MFO217G	10		9316101050679
300 x 300 x 25 x 5mm	MFO218G	10		9316101050686
350 x 250 x 25 x 5mm	MFO219G	10		9316101050693
350 x 350 x 25 x 5mm	MFO220G	10		9316101050709
400 x 250 x 25 x 5mm	MFO221G	10		9316101050716
500 x 400 x 25 x 5mm	MFO222G	10		9316101050723

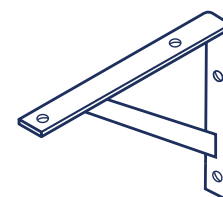

Multi Purpose Bracket Range – Galvanised

PRODUCT NAME	CODE	QTY	WHLSALE	APN CODE
Heavy Duty Shelf Angle Brkt w Stay – M12 holes (x4)				
400 x 300 x 50 x 5mm	HMFO223G	10		9316101050730
500 x 400 x 50 x 5mm	HMFO224G	10		9316101050747

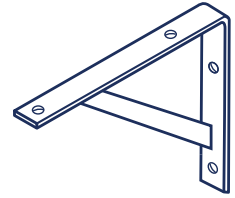

Timber Angle Bracket – M12 holes (x4)				
210 x 60 x 50 x 6mm	MTB2106G	20		9316101050754
210 x 130 x 50 x 6mm	MTB2113G	20		9316101050761
280 x 60 x 50 x 6mm	MTB2806G	20		9316101050778

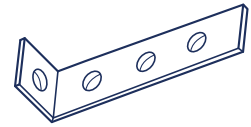

L Timber Bracket – M6 holes (x9)				
190 x 190 x 40 x 5mm	MTL190G	25		9316101050785

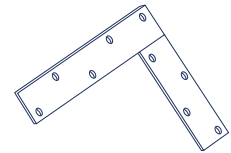

T Timber Bracket – M6 holes (x9)				
190 x 190 x 40 x 5mm	MTT190G	25		9316101050792

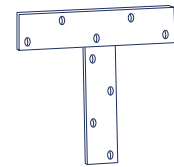

Wall & Roof Bracing

PRODUCT NAME	CODE	QTY	WHLSALE
Wallbrace			
3.0 Metre lengths	WB30	10	
3.3 Metre lengths	WB33	10	
3.6 Metre lengths	WB36	10	
3.9 Metre lengths	WB39	10	
4.2 Metre lengths	WB42	10	
4.5 Metre lengths	WB45	10	
4.8 Metre lengths	WB48	10	

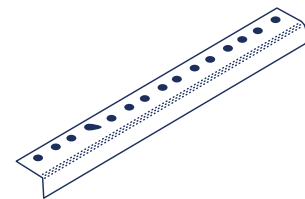

Roofbrace			
3.0 Metre lengths	RB30	10	
3.6 Metre lengths	RB36	10	
4.0 Metre lengths	RB40	10	
5.0 Metre lengths	RB50	10	
6.0 Metre lengths	RB60	10	

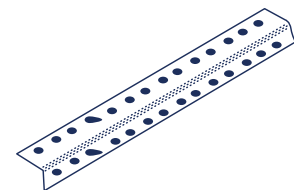

Plaster Angle

PRODUCT NAME	CODE	QTY	WHLSALE
Plaster Angle			
Internal (unpncd 2.4m Lgth)	IPA	20	
External 2.4m Lengths	EPA	20	
External 2.7m Lengths	EPA27	20	

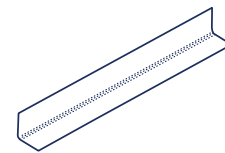

Steel Lintels – Painted (Price per metre)

PRODUCT NAME	CODE	WHLSALE
Flats		
75 x 6 mm Flat	FL756P	
75 x 8 mm Flat	FL758P	
75 x 10 mm Flat	FL7510P	

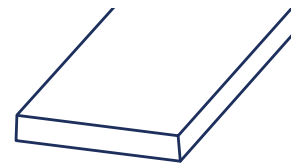

Angles		
100 x 75 x 6 mm Angle	UA100756P	
100 x 100 x 6 mm Angle	EA1001006P	
100 x 100 x 8 mm Angle	EA1001008P	
100 x 100 x 10 mm Angle	EA10010010P	
150 x 90 x 8 mm Angle	UA150908P	
150 x 100 x 10 mm Angle	UA15010010P	

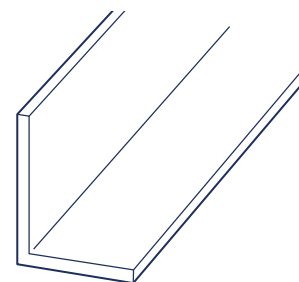

T-Bars		
200 x 200 x 6 mm Tee	TB20062006P	
200 x 200 x 8 mm Tee	TB20082008P	
200 x 200 x 10 mm Tee	TB2001020010P	
200 x 200 x 12 mm Tee	TB2001220012P	
200 x 10 H x 250 x 10 mm V Tee	TB2001025010P	
200 x 6 H x 150 x 10 mm V Tee	TB200615010P	
200 x 6 H x 200 x 8 mm V Tee	TB20062008P	
200 x 8 H x 150 x 8 mm V Tee	TB20081508P	
200 x 10 H x 200 x 6 mm V Tee	TB200102006P	
200 x 10 H x 200 x 8 mm V Tee	TB200102008P	
200 x 10 H x 150 x 10 mm V Tee	TB2001015010P	
200 x 10 H x 200 x 12 mm V Tee	TB2001020012P	
200 x 10 H x 250 x 12 mm V Tee	TB2001025012P	
200 x 12 H x 250 x 12 mm V Tee	TB2001225012P	

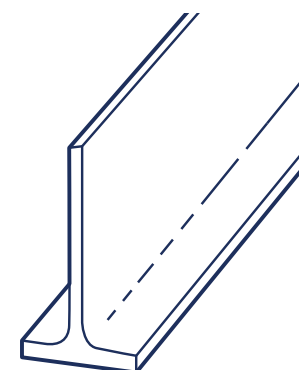

Steel Lintels – Painted (Price per metre)

PRODUCT NAME	CODE	WHLSALE
Beams		
150 UB 14	UB15014P	
150 UB 18	UB15018P	
180 UB 16	UB18016P	
180 UB 18	UB18018P	
180 UB 22	UB18022P	
200 UB 18	UB20018P	
200 UB 22	UB20022P	
200 UB 25	UB20025P	
200 UB 30	UB20030P	
250 UB 26	UB25026P	
250 UB 31	UB25013P	
250 UB 37	UB25037P	

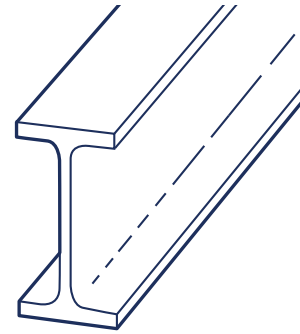

Channels		
100 x 50 mm PFC	CH100P	
125 x 65 mm PFC	CH125P	
150 x 75 mm PFC	CH150P	
180 x 75 mm PFC	CH180P	
200 x 75 mm PFC	CH200P	
230 x 75 mm PFC	CH230P	
250 x 90 mm PFC	CH250P	
300 x 90 mm PFC	CH300P	
380 x 100 mm PFC	CH380P	

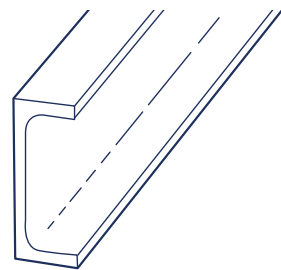

Universal Columns		
97 x 99 mm UC	UC10015P	
152 x 152 mm UC	UC15024P	

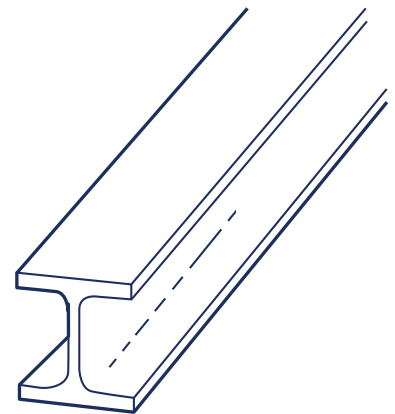

Steel Lintels – Galvanised (Price per metre)

Flats		
75 x 6 mm Flat	FL756G	
75 x 8 mm Flat	FL758G	
75 x 10 mm Flat	FL7510G	

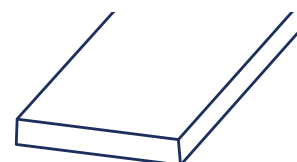

Steel Lintels – Galvanised (Price per metre)

PRODUCT NAME	CODE	WHLSALE
Angles		
100 x 75 x 6 mm Angle	UA100756G	
100 x 100 x 6 mm Angle	EA1001006G	
100 x 100 x 8 mm Angle	EA1001008G	
100 x 100 x 10 mm Angle	EA10010010G	
150 x 90 x 8 mm Angle	UA150908G	
150 x 100 x 10 mm Angle	UA15010010G	

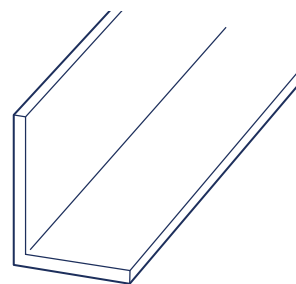

T-Bars		
200 x 200 x 6 mm Tee	TB20062006G	
200 x 200 x 8 mm Tee	TB20082008G	
200 x 200 x 10 mm Tee	TB2001020010G	
200 x 200 x 12 mm Tee	TB2001220012G	
200 x 10 H x 250 x 10 mm V Tee	TB2001025010G	
200 x 6 H x 150 x 10 mm V Tee	TB200615010G	
200 x 6 H x 200 x 8 mm V Tee	TB20062008G	
200 x 8 H x 150 x 8 mm V Tee	TB20081508G	
200 x 10 H x 200 x 6 mm V Tee	TB200102006G	
200 x 10 H x 200 x 8 mm V Tee	TB200102008G	
200 x 10 H x 150 x 10 mm V Tee	TB2001015010G	
200 x 10 H x 200 x 12 mm V Tee	TB2001020012G	
200 x 10 H x 250 x 12 mm V Tee	TB2001025012G	
200 x 12 H x 250 x 12 mm V Tee	TB2001225012G	

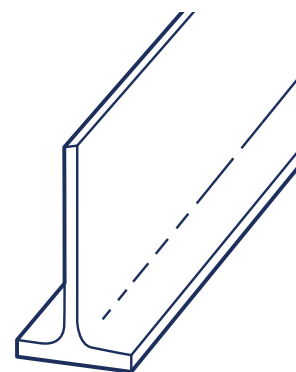

Beams		
150 UB 14	UB15014G	
150 UB 18	UB15018G	
180 UB 16	UB18016G	
180 UB 18	UB18018G	
180 UB 22	UB18022G	
200 UB 18	UB20018G	
200 UB 22	UB20022G	
200 UB 25	UB20025G	
200 UB 30	UB20030G	
250 UB 26	UB25026G	
250 UB 31	UB25013G	
250 UB 37	UB25037G	

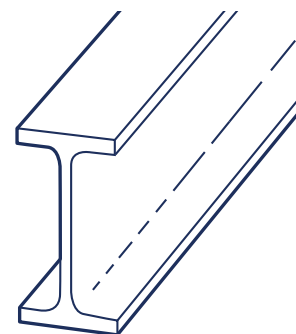

Steel Lintels – Galvanised (Price per metre)

PRODUCT NAME	CODE	WHLSALE
Channels		
100 x 50 mm PFC	CH100G	
125 x 65 mm PFC	CH1 25G	
150 x 75 mm PFC	CH1 50G	
180 x 75 mm PFC	CH1 80G	
200 x 75 mm PFC	CH2 00G	
230 x 75 mm PFC	CH2 30G	
250 x 90 mm PFC	CH2 50G	
300 x 90 mm PFC	CH3 00G	
380 x 100 mm PFC	CH380G	

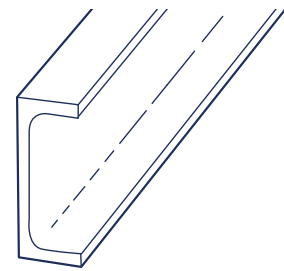

Universal Columns		
97 x 99 mm UC	UC10015G	
152 x 152 mm UC	UC15024G	

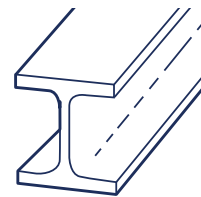

Steel Pit Frame & Grate Sets

Steel Pit Frame & Grate Sets – Galvanised		
230mm x 230mm	SSP9G	
300mm x 300mm	SSP12G	
380mm x 380mm	SSP15G	
455mm x 455mm	SSP18G	
500mm x 500mm	SSP20G	
600mm x 600mm	SSP24G	
700mm x 700mm	SSP28G	

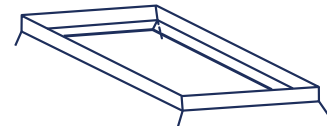

Heavy Duty Pit Frame & Grate Sets – Galvanised		
230mm x 230mm	SHDSP9G	
300mm x 300mm	SHDSP12G	
380mm x 380mm	SHDSP15G	
455mm x 455mm	SHDSP18G	
500mm x 500mm	SHDSP20G	
600mm x 600mm	SHDSP24G	
700mm x 700mm	SHDSP28G	





