

giving you the edge

*Sterling*<sup>®</sup>



STERLING TOOLS  
**PRODUCT CATALOGUE 2013**

A BRAND OF SHEFFIELD BLADES



**SHEFFIELD BLADES**

## **Our Mission**

To provide complete solutions in cutting tools and power tool accessories

## **Our Vision**

A Sterling tool in every hand

## **Our Values**

### **Integrity**

*Loyal, Honest, Sincere*

### **Dependability**

*Informed, Consistent, Systematic, Focused*

### **Service**

*Superb, Comprehensive, Reliable,  
Prompt, Courteous*

# Contents

Introduction **5**  
Blade Selection Guide **8**

**11**   
Retractable  
Trimming  
Knives

**19**   
Fixed  
Trimming  
Knives

**25**   
18mm  
Cutters

**33**   
9mm  
Cutters

**39**   
Safety  
Knives &  
Cutters

**53**   
Miscellaneous  
Knives &  
Tools

**61**   
Saws

**65**   
Hammers

**67**   
Flooring &  
Carpet  
Tools

**75**   
Slidlock  
Trowels

**79**   
Floor Dot  
Range

**87**   
Scrapers

**103**   
Mitre & Other  
Shears

**107**   
Industrial  
& Tin Snips

**113**   
Shears

**125**   
Graphic  
Art Knives  
& Tools

**131**   
Cutting  
Mats

**135**   
Rotary  
Cutters

**137**   
Rulers

**141**   
Measuring  
Tapes

**153**   
Holsters

**157**   
Staplers  
& Staples

**171**   
Hacksaw  
Blades

**175**   
Trimming  
Blades

**185**   
Snap-Off  
Blades

**193**   
Scraping  
Blades

**201**   
Graphic Art  
Blades

**211**   
Slitting  
Blades

**217**   
Scalpel  
Blades

**221**   
Deburring  
Tools

**229**   
Display  
Stands

**232**  
Index



SHEFFIELD BLADES

55

**Sheffield Blades is a fourth generation Australian owned and operated family company.** We are dedicated to the success of your business through superior quality, service and integrity. Sheffield Blades provides complete solutions in cutting tools through its extensive range of Sterling knives and blades, and in power tool accessories through its ever growing Alpha range.

## About Sheffield



**With over 40 years of experience we can assure the highest level of expertise.** By means of extensive ongoing consultation with industry specialists and our valued clients, *we have developed a range of solutions* to more than satisfy the most demanding requirements. Improvements through innovation and implementation of efficiencies affected by

constantly upgrading systems and staff training will continue to drive us forward.

Backed by a large and ever expanding stock level in our centrally located warehouse, our highly trained warehouse team, in conjunction with an extremely efficient distribution network, ensure an awesome level of service to clients throughout Australia.

Our *exclusive* brands **Sterling** and **Alpha** are sold by industrial distributors in Australia, and with over 2,000 outlets throughout the country there is a stockist near to you.

## Customer satisfaction is our top priority.

When you contact our Sales or Service Team you will speak with *trained and dedicated staff members* that genuinely care about providing you with the product or service that is best for you.

“ **Sheffield Blades** provides complete solutions in cutting tools through its extensive range of Sterling knives and blades, and in power tool accessories through its ever growing Alpha range.

”

# Service





# SHEFFIELD BLADES



**Sheffield Blades Head Office and Warehouse, located in Newcastle, is excellently situated to provide overnight service for orders to all major cities on the Eastern seaboard of Australia.**

Overnight service to all other areas is available on request.

Orders placed before 2pm EST are normally dispatched the same day with a virtually 100% guaranteed accuracy level. By use of our *electronic dispatch system* the quickest method of delivery for that specific consignment is selected. For your peace of mind a *confirmation of dispatch* is sent to you by *email* providing you with full tracking capability for your consignment.

*The team at Sheffield Blades strive to exceed expectations in offering helpful service and advice to businesses throughout Australia along with practical solutions to solve any problems.*







## 25mm Cutters



## 18mm Screwlock Cutters



| Knife Code            |             | 701       | 700       | H-13      | 760-1     |
|-----------------------|-------------|-----------|-----------|-----------|-----------|
| <b>Blades to suit</b> | <b>Page</b> | <b>22</b> | <b>22</b> | <b>23</b> | <b>23</b> |
| 207                   | 188         | •         | •         | •         | •         |
| HB-10BH               | 188         | •         | •         | •         | •         |
| 209                   | 188         | •         | •         | •         | •         |
| 201-2BH               | 186         |           |           |           |           |
| 201                   | 185         |           |           |           |           |
| 1404-L                | 186         |           |           |           |           |
| 203                   | 187         |           |           |           |           |
| GB-10H                | 186         |           |           |           |           |
| KDLB-10BH             | 187         |           |           |           |           |

| 580 | L-25 | 590 | 500 | 570 | 550 |
|-----|------|-----|-----|-----|-----|
| 25  | 26   | 26  | 27  | 27  | 27  |
|     |      |     |     |     |     |
| •   | •    | •   | •   | •   | •   |
| •   | •    | •   | •   | •   | •   |
| •   | •    | •   | •   | •   | •   |
| •   | •    | •   | •   | •   | •   |
| •   | •    | •   | •   | •   | •   |

## 18mm Autolock Cutters



| Knife Code            |             | 680       | 690       | 625       | 670       | 655       | 902       | 80        | 68        | D-803     |
|-----------------------|-------------|-----------|-----------|-----------|-----------|-----------|-----------|-----------|-----------|-----------|
| <b>Blades to suit</b> | <b>Page</b> | <b>28</b> | <b>28</b> | <b>29</b> | <b>29</b> | <b>30</b> | <b>30</b> | <b>31</b> | <b>31</b> | <b>31</b> |
| 201-2BH               | 186         | •         | •         | •         | •         | •         | •         | •         | •         | •         |
| 201                   | 185         | •         | •         | •         | •         | •         | •         | •         | •         | •         |
| 1404-L                | 186         | •         | •         | •         | •         | •         | •         | •         | •         | •         |
| 203                   | 187         | •         | •         | •         | •         | •         | •         | •         | •         | •         |
| GB-10H                | 186         | •         | •         | •         | •         | •         | •         | •         | •         | •         |
| KDLB-10BH             | 187         | •         | •         | •         | •         | •         | •         | •         | •         | •         |

## 9mm Cutters

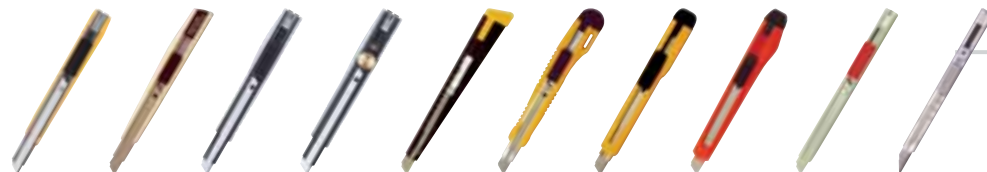

| Knife Code            |             | 330       | A-300     | 340       | 380       | 220       | 905       | 128       | D-804     | 360       | S-18      |
|-----------------------|-------------|-----------|-----------|-----------|-----------|-----------|-----------|-----------|-----------|-----------|-----------|
| <b>Blades to suit</b> | <b>Page</b> | <b>33</b> | <b>34</b> | <b>35</b> | <b>35</b> | <b>36</b> | <b>36</b> | <b>36</b> | <b>36</b> | <b>37</b> | <b>37</b> |
| 1402                  | 190         | •         | •         | •         | •         | •         | •         |           |           | •         | •         |
| 200                   | 190         | •         | •         | •         | •         | •         | •         | •         | •         | •         | •         |
| 202                   | 191         | •         | •         | •         | •         | •         | •         | •         | •         | •         | •         |
| 1403-S                | 191         | •         | •         | •         | •         | •         | •         | •         | •         | •         | •         |
| SB-50H                | 191         | •         | •         | •         | •         | •         | •         | •         | •         | •         | •         |

BLADE SELECTION GUIDE

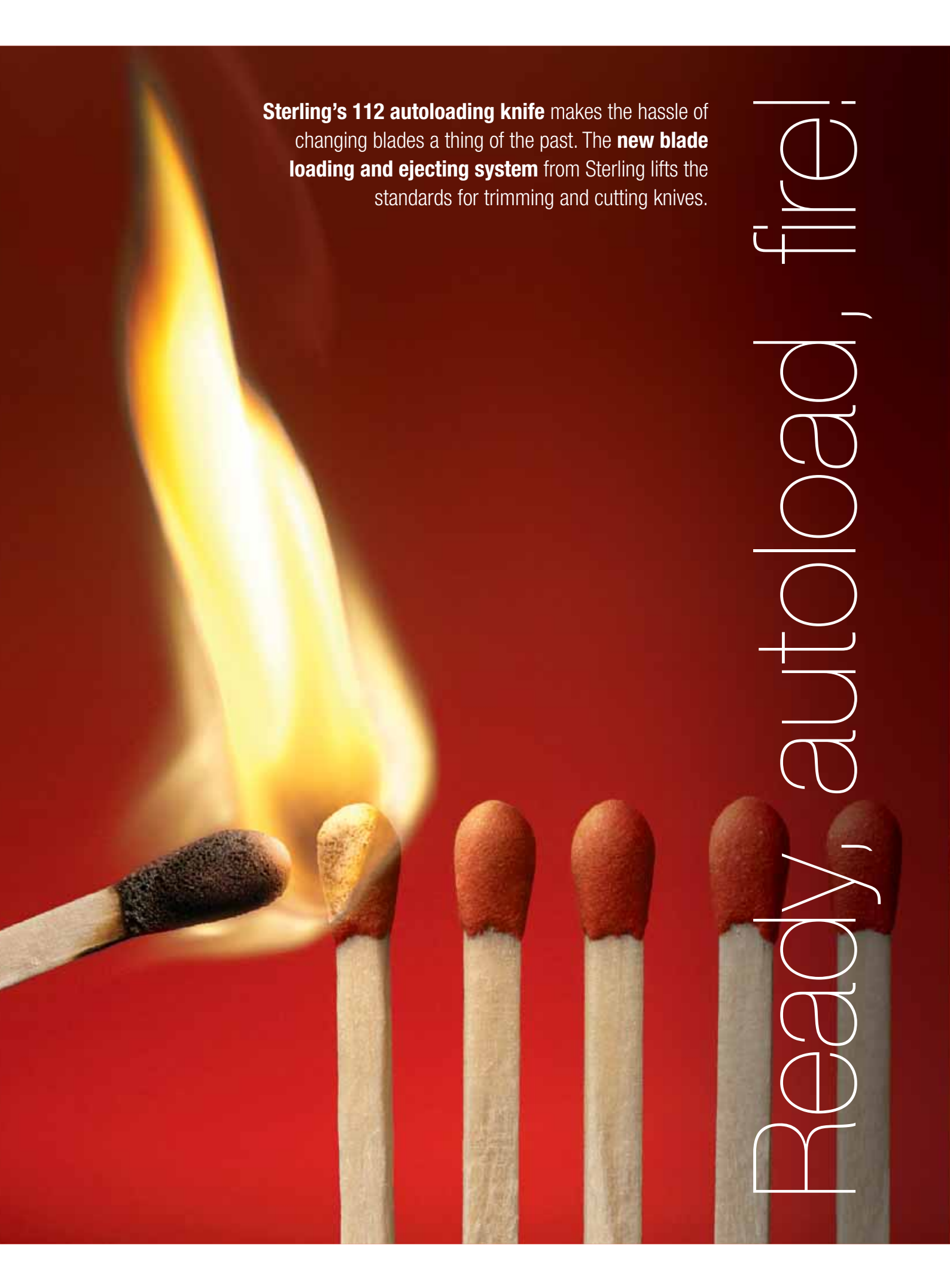

**Sterling's 112 autoloading knife** makes the hassle of changing blades a thing of the past. The **new blade loading and ejecting system** from Sterling lifts the standards for trimming and cutting knives.

Ready, autoloader, fire!

# auto



## 112 Autoloading



### AUTOLOADING KNIFE WITH RUBBER GRIP

| CODE             | DESCRIPTION   | BOX QTY | CTN QTY |
|------------------|---|---------|---------|
| <b>112-1</b>     | Silver/Red Carded + 5 blades  | 6       | 48      |
| <b>112-COMBO</b> | Knife, Holster + 10 Blades Combo - Carded                                       | 6       | 6       |
| <b>112-DISP</b>  | Display box incl:<br>12 x <b>112-1</b> , 20 x <b>921-4D</b> , 5 x <b>921-2D</b> | 1       | 1       |

- 5 blade magazine automatically re-loads new blades
- Front loading with safety button allows used blades to be removed or turned around without opening knife body
- Heavy duty all metal construction with smooth reliable mechanism
- Unique shape for superior grip & control
- Easy blade loading reduces accidents
- All metal mechanisms - metal springs & slides

Suggested replacement blades:

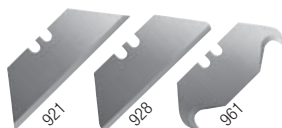

**Carded**



**112-COMBO**  
Knife & Holster Combo

See pgs. 175-183



Sterling



115-2Y Ultra-Grip

Sterling

### RETRACTABLE TRIMMING KNIFE HI-VIS

| CODE           | DESCRIPTION              | BOX QTY | CTN QTY |
|----------------|--------------------------|---------|---------|
| <b>115-2Y</b>  | Yellow Bulk              | 20      | 120     |
| <b>115-2BY</b> | Yellow Bulk + 3 Blades   | 50      | 100     |
| <b>115-1Y</b>  | Yellow Carded + 3 Blades | 6       | 120     |

- The most popular Sterling retractable knife
- Ribbed body for improved hand grip with gloves
- Die cast zinc construction for longer life
- Large overlap above and below blade to prevent injuries
- Ergonomic shape fits all size hands
- Hi-vis safety yellow stands out for easy locating



Self Retracting **115-1YR**  
See pg. 42

Suggested replacement blades:



**STC65** Holster Available  
See pg. 155



See pgs. 175-183



115-2G Ultra-Grip

Sterling

### RETRACTABLE TRIMMING KNIFE GREY

| CODE           | DESCRIPTION            | BOX QTY | CTN QTY |
|----------------|------------------------|---------|---------|
| <b>115-2G</b>  | Grey Bulk              | 20      | 120     |
| <b>115-2BG</b> | Grey Bulk + 3 Blades   | 50      | 100     |
| <b>115-1G</b>  | Grey Carded + 3 Blades | 6       | 120     |

- The most popular Sterling retractable knife
- Ribbed body for improved hand grip with gloves
- Die cast zinc construction for longer life
- Large overlap above and below blade to prevent injuries
- Ergonomic shape fits all size hands

Suggested replacement blades:



**STC65** Holster Available  
See pg. 155



See pgs. 175-183

Sterling®



## Sterling® 115 Thumlock

### ULTRA-GRIP THUMLOCK KNIFE HI-VIS

| CODE           | DESCRIPTION              | BOX QTY | CTN QTY |
|----------------|--------------------------|---------|---------|
| <b>115-2YS</b> | Yellow Bulk              | 20      | 120     |
| <b>115-1YS</b> | Yellow Carded + 3 Blades | 6       | -       |
| <b>115-2GS</b> | Grey Bulk                | 20      | 120     |
| <b>115-1GS</b> | Grey Carded + 3 Blades   | 6       | -       |

- Ultra-Grip retractable trimming knife with quick release screw
- No Screwdriver needed to change blades
- All 115 Ultra-Grip unique features
- Thumlock available in Yellow and Grey
- Holsters available *See pg. 153-155*



Self Retracting **115-1YRS**  
*See pg. 39*

Suggested replacement blades:



*See pgs. 175-183*



## Sterling® 114 Rubber-Grip

### RETRACTABLE TRIMMING KNIFE

| CODE         | DESCRIPTION   | BOX QTY | CTN QTY |
|--------------|---------------|---------|---------|
| <b>114-1</b> | Yellow Carded | 12      | 120     |

- Rubber sides give extra grip
- Easy blade changes with quick release screw
- Interlocking halves prevent knife from spreading apart
- Die cast zinc construction for longer life
- Blade magnet prevents blade falling out during changes
- 114-2R Auto retracting version available *See pg. 40*



Self Retracting **114-2R**  
*See pg. 40*

Suggested replacement blades:



*See pgs. 175-183*



## Sterling® 118 Rhino-Grip

### RHINO-GRIP RETRACTABLE TRIMMING KNIFE

| CODE         | DESCRIPTION        | BOX QTY | CTN QTY |
|--------------|--------------------|---------|---------|
| <b>118-2</b> | Yellow Display Box | 12      | 48      |

- Quick clip opening for fast and easy blade changes
- Large overlap on castings to prevent injuries and increase durability
- Ribbed rubber sides provide extra grip and comfort
- Comes with Free Holster



Suggested replacement blades:



*See pgs. 175-183*



## Sterling® 117 Fast-Lock

### FAST-LOCK RETRACTABLE TRIMMING KNIFE

| CODE         | DESCRIPTION            | BOX QTY | CTN QTY |
|--------------|------------------------|---------|---------|
| <b>117-2</b> | Display Box + 5 Blades | 12      | 48      |

- Comfortable ergonomic shape with rubber grip
- Fast blade changes with quick release slide button
- Blade magnet prevents blade falling out during changes
- Die cast zinc all metal construction for longer life
- Supplied with handy belt holster



Suggested replacement blades:



*See pgs. 175-183*



119-2D Fluro



### FLURO RETRACTABLE TRIMMING KNIFE

| CODE          | DESCRIPTION             | BOX QTY | CTN QTY |
|---------------|-------------------------|---------|---------|
| <b>119-2D</b> | Fluro Display Box of 36 | 36      | 72      |

- Die cast zinc all metal construction including blade holder
- 12 yellow, 12 green, 12 orange knives per display
- Excellent value in the traditional shape
- Blade storage in knife body
- Overlap above & below blade to prevent injuries
- Hi-Vis colours for easy locating

Suggested replacement blades:



**119-DISP** Display Box of 36

See pgs. 175-183



### Sterling **e** 119-2 Grey

#### GREY RETRACTABLE TRIMMING KNIFE

| CODE          | DESCRIPTION    | BOX QTY | CTN QTY |
|---------------|----------------|---------|---------|
| <b>119-1</b>  | Yellow Carded  | 10      | 100     |
| <b>119-2</b>  | Grey Bulk      | 10      | 100     |
| <b>119-2S</b> | Grey Thumlock* | 20      | 120     |

- Die cast zinc all metal construction including blade holder
- Excellent value in the traditional shape
- Blade storage in knife body
- Overlap above & below blade to prevent injuries
- Also available with Thumlock\* screw for easy blade changes without a screwdriver

Suggested replacement blades:



See pgs. 175-183



### Sterling **e** 110 Mini

#### MINI RETRACTABLE TRIMMING KNIFE (OVERALL LENGTH - 80MM)

| CODE            | DESCRIPTION | BOX QTY | CTN QTY |
|-----------------|-------------|---------|---------|
| <b>110-MINI</b> | Silver Bulk | 60      | 600     |

- Takes one hole mini blade Code 03-043. See pg. 214
- Mini Size overall length 80mm
- Die cast Aluminium construction
- Suitable for promotions and giveaways

Suggested replacement blades:



See pg. 214

## 3038 Stealth Knife



### STEALTH KNIFE

| CODE        | DESCRIPTION | BOX QTY | CTN QTY |
|-------------|-------------|---------|---------|
| <b>3038</b> | Red Carded  | 12      | 24      |

- Automatic blade loading
- Highest quality blades
- Slide-lock retractable blade
- Quick-flip blade change function
- Comfortable shaped grip
- 5 blade storage compartment

Suggested replacement blades:



See pgs. 175-183

Carded



## 3038 Stealth Display



### STEALTH KNIFE DISPLAY OF 12

| CODE             | DESCRIPTION | BOX QTY | CTN QTY |
|------------------|-------------|---------|---------|
| <b>3038-DISP</b> | Display box | 12      | 24      |

**TRY IT OUT!**  
OUR CUSTOM  
DESIGNED PACKS  
FEATURE A CUTAWAY  
SO YOU CAN TRY THE  
KNIFE YOURSELF!



## 3022 Redneck



Carded



### REDNECK FOLDING HEAVY DUTY KNIFE

| CODE        | DESCRIPTION      | BOX QTY | CTN QTY |
|-------------|------------------|---------|---------|
| <b>3022</b> | Red/Black Carded | 10      | 100     |

- Rubber grip to prevent slipping
- Fold out locking design with central release button
- Super tough construction for heavy cutting
- The fixed blade knife that is Safer to use
- Lock in, lock out safety

Suggested replacement blades:

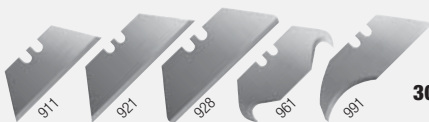

**3022-DISP** Display Box of 10

See pgs. 175-183

## 3035 SportsPro



Carded



### SPORTSPRO MULTI USE SPORTS KNIFE

| CODE        | DESCRIPTION                         | BOX QTY | CTN QTY |
|-------------|-------------------------------------|---------|---------|
| <b>3035</b> | Stainless Steel Sports/Rescue Blade | 6       | 24      |

- Fold out locking design
- Extra fold out multi-use blade
- Easy blade changes with the push of a lever
- Rubber grip sides to prevent slipping
- Supplied with nylon holster

Suggested replacement blades:



**3035-DISP** Display Box of 6

See pgs. 175-183





Sterling Double Stand



*Sterling*

**STERLING DOUBLE LARGE DISPLAY STAND**

| CODE            | DESCRIPTION                         |
|-----------------|-------------------------------------|
| <b>LGSTER02</b> | Large Double Sterling Display 2     |
| Dimensions      | 2100mm (H) x 2500mm (W) x 500mm (D) |

- Awesome presentation of complete Sterling range
- Ideal for Trade, Industrial & Hardware Suppliers
- Standard options available
- Fully customisable to suit your showroom
- Display lighting
- Ask your Account Manager for a range of merchandising options

**For a full range of Sterling Display options,**  
turn to page 229.

Ideally constructed for heavy duty use, the **Sterling 105 Shark** knife features a quick release dial for fast, easy blade changes. A cast **aluminium construction and comfortable shape** makes this versatile knife **strong, light and easy to use.**



Dial S-H-A-R-K



Ergonomic shape

Quick release dial

Holds blade securely

# 105 Shark



## SHARK FIXED TRIMMING KNIFE

| CODE         | DESCRIPTION   | BOX QTY | CTN QTY |
|--------------|---------------|---------|---------|
| <b>105-2</b> | Silver Carded | 6       | 60      |

- Ideal for heavy duty uses
- Quick release "dial" for fast, easy blade changes
- Ergonomic shape fits securely & comfortably in the hand
- Cast aluminum construction is strong but very light
- Single notch to adjust blade length
- Supplied with plastic belt holster
- Clamps blade securely - no movement
- Ideal for Flooring, Plasterboard, Mining, Rubber belting & other industries

Suggested replacement blades:



See pgs. 175-183



**Carded**



**105-2** Knife & holster



**105-DISP** Display Box of 6

fixed

19



FIXED TRIMMING KNIVES



## Sterling® 104 Lockset

### LOCKSET FIXED TRIMMING KNIFE

| CODE         | DESCRIPTION         | BOX QTY | CTN QTY |
|--------------|---------------------|---------|---------|
| <b>104-1</b> | Silver/Black Carded | 12      | 120     |

- Interlocking design clamps blade securely
- Easy blade changes without screwdriver
- Rubber grip on sides
- Die cast zinc for longer life
- Zero blade movement
- Ideal for rubber belting

Suggested replacement blades:



See pgs. 175-183



## Sterling® 102 Ultra-Lap

### ULTRA-LAP FIXED TRIMMING KNIFE

| CODE          | DESCRIPTION              | BOX QTY | CTN QTY |
|---------------|--------------------------|---------|---------|
| <b>102-2</b>  | Silver Bulk              | 25      | 200     |
| <b>102-2B</b> | Silver Bulk + 3 Blades   | 25      | 200     |
| <b>102-1</b>  | Silver Carded + 3 Blades | 6       | 6       |

- The most popular carpet laying knife
- Traditional style knife with knurled sides for grip
- Large overlaps to prevent injuries
- Die cast aluminum is strong and light weight
- Double notches for reduced wear

Suggested replacement blades:



See pgs. 175-183



## Sterling® 102 Ring-Lock

### RING-LOCK FIXED TRIMMING KNIFE

| CODE           | DESCRIPTION             | BOX QTY | CTN QTY |
|----------------|-------------------------|---------|---------|
| <b>102-2R</b>  | Silver Bulk             | 10      | 120     |
| <b>102-2RD</b> | Fluro Display Box of 36 | 36      | 144     |

- Fast easy blade changes with Ring-Lock screw
- Screw has ring for easy tightening and turning
- Recessed screw does not protrude to allow for close cuts
- Single notch to adjust blade depth
- Large overlaps to prevent injuries
- Die cast zinc construction for long life

Suggested replacement blades:



See pgs. 175-183



## Sterling® 102 Thumlock

### ULTRA-LAP THUMLOCK FIXED KNIFE

| CODE          | DESCRIPTION              | BOX QTY | CTN QTY |
|---------------|--------------------------|---------|---------|
| <b>102-2S</b> | Silver Bulk              | 25      | 200     |
| <b>102-1S</b> | Silver Carded + 3 Blades | 6       | 6       |

- Quick release Thumlock screw eliminates the need of a screwdriver when changing blades
- Traditional style knife with knurled sides for grip
- Large overlaps to prevent injuries
- Die cast aluminum is strong and light weight
- Double notches for reduced wear

Suggested replacement blades:



See pgs. 175-183



## 106 Quick-Change

### QUICK-CHANGE FIXED TRIMMING KNIFE

| CODE         | DESCRIPTION       | BOX QTY | CTN QTY |
|--------------|-------------------|---------|---------|
| <b>106-2</b> | Green Display Box | 12      | 48      |

- Ergonomic 'bent' style for more leverage on heavy cutting jobs
- Fast & easy blade changes with pull back & twist end cap
- Double notches to hold blade securely & reduce wear
- Supplied in handy belt holster
- Comes with Free holster



Suggested replacement blades:



**107-2 DISP** Display Box of 12

See pgs. 175-183



## 107 Hard-Edge

### HARD EDGE FIXED TRIMMING KNIFE

| CODE         | DESCRIPTION              | BOX QTY | CTN QTY |
|--------------|--------------------------|---------|---------|
| <b>107-2</b> | Silver/Black Display Box | 12      | 48      |

- Comfortable ergonomic "bent" shape
- Fast blade changes with quick release button
- Blade magnet prevents blade falling out during changes
- Die cast zinc for longer life
- Double notches to hold blade securely and reduce wear
- Supplied with convenient belt holster



Suggested replacement blades:



**107-2 DISP** Display Box of 12

See pgs. 175-183



## 109 Swivel-Lock



### SWIVEL-LOCK FIXED TRIMMING KNIFE

| CODE         | DESCRIPTION           | BOX QTY | CTN QTY |
|--------------|-----------------------|---------|---------|
| <b>109-1</b> | Yellow Carded/Display | 24      | 96      |

- Angled head design for ease of use
- Push button, swivel action for quick blade replacement
- Rubberized finish provides non-slip grip
- Blade magnet prevents blade falling out during changes
- Die cast zinc for longer life
- Swivel clamping action
- Zero Blade Movement



**109-1 DISP** Display Box of 24

Suggested replacement blades:



See pgs. 175-183



**Carded**



## 701 Red-Rhino



### RED-RHINO 25MM SCREW-LOCK EXTRA LARGE CUTTER

| CODE         | DESCRIPTION | BOX QTY | CTN QTY |
|--------------|-------------|---------|---------|
| <b>701-1</b> | Red Carded  | 10      | 120     |

- Wider and thicker (0.7mm) blade reduces flex and stands up to heavy cutting of rubber, windscreen removal, insulation etc
- Screw-lock provides secure, positive blade locking
- Rubber grip reduces hand slipping when applying pressure
- Comfortable "tear drop" shape better for gloved hands
- Extra thick Stainless Steel sleeve for longer life

Suggested replacement blades:

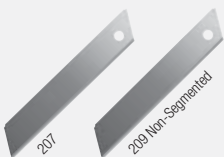

**Carded**



See pg. 188

## H-13 Job-Boss



### JOB-BOSS 25MM SCREW-LOCK EXTRA LARGE CUTTER

| CODE             | DESCRIPTION                         | BOX QTY | CTN QTY |
|------------------|-------------------------------------|---------|---------|
| <b>H-13</b>      | Black Carded                        | 10      | 100     |
| <b>H-12YE-3B</b> | Yellow Carded + Extra 3 Pack Blades | 36      | 36      |

- Extra large extra heavy duty 25mm wide cutter
- Super Sharp Power Black blade 25mm wide x 0.7mm thick
- Soft grip rubberized body is comfortable and reduces slipping
- Secure Screw-Lock
- Tough on the job, easy on the hand

Suggested replacement blades:

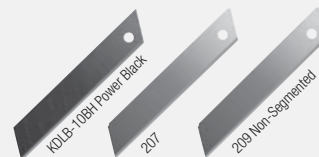

**Carded**



See pgs. 187, 188

Sterling®

## 700 Extra Large

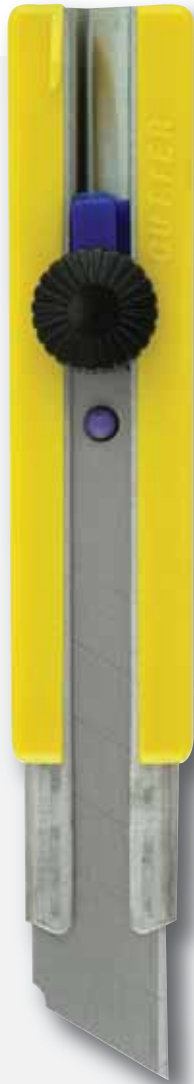

Sterling®

### YELLOW 25MM SCREW-LOCK EXTRA LARGE CUTTER

| CODE         | DESCRIPTION   | BOX QTY | CTN QTY |
|--------------|---------------|---------|---------|
| <b>700-1</b> | Yellow Carded | 10      | 120     |

- The most popular 25mm extra heavy duty cutter
- Screw-Lock provides peace of mind when tightening blade
- Rubber grip on back reduces hand slipping when applying pressure
- Extra thick Stainless Steel sleeve for longer life
- Supplied with 2 blades

Suggested replacement blades:

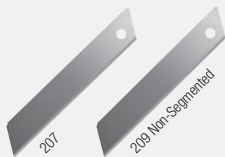

Carded



See pg. 188

## 760 Commander



Sterling®

### COMMANDER 25MM AUTO-LOCK EXTRA LARGE CUTTER

| CODE         | DESCRIPTION   | BOX QTY | CTN QTY |
|--------------|---------------|---------|---------|
| <b>760-1</b> | Silver Carded | 12      | 48      |

- Extra Heavy Duty 25mm Cutter with STRONG AUTO-LOCK SYSTEM for fast, safe blade adjustments
- All metal construction is durable and strong
- Ribbing on body to provide secure grip
- Metal clip and blade snapper on back of cutter
- Wider and thicker 0.7mm blade reduces flex in heavy cutting

Suggested replacement blades:

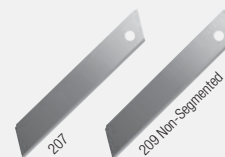

Carded



See pg. 188

A close-up, vertical view of a zebra's coat, showing the characteristic black and white stripes. The stripes are slightly wavy and run vertically across the frame. The lighting is even, highlighting the texture of the fur.

A feisty knife with secure, positive holding power, the **Sterling Zebra cutter** features strong, durable **stainless steel sleeve**, lightweight **aluminium casing**, and comfortable, **secure rubber grip** - ready to grab and go!

Raring to go



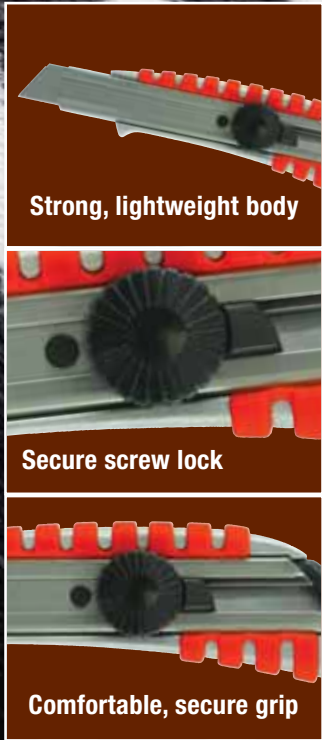

Strong, lightweight body

Secure screw lock

Comfortable, secure grip

# 580 Zebra



*Sterling*<sup>®</sup>

### ZEBRA 18MM LARGE SCREW-LOCK CUTTER

| CODE  | DESCRIPTION       | BOX QTY | CTN QTY |
|-------|-------------------|---------|---------|
| 580-1 | Silver/Red Carded | 12      | 144     |

- Aluminium casing is strong but lightweight
- Rubber hand grip is comfortable and secure
- Strong long lasting Stainless Steel blade slider
- Screw Lock blade locking for secure, positive holding power

Suggested replacement blades:

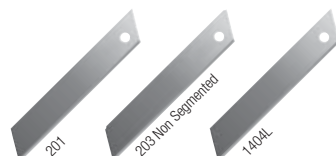

See pgs. 185-187



Carded

# 18mm

*Sterling*<sup>®</sup>



### 590 All-Metal



#### ALL-METAL 18MM SCREW-LOCK CUTTER

| CODE  | DESCRIPTION   | BOX QTY | CTN QTY |
|-------|---------------|---------|---------|
| 590-1 | Silver Carded | 12      | 120     |

- Super tough All-Metal die cast body will not break
- Strong Screw-Lock mechanism
- Extra thick Stainless Steel insert
- Rubber grip on the back reduces slipping
- Supplied with blade snapper on the back of cutter

Suggested replacement blades:

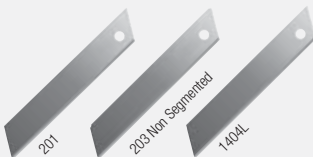

Carded



See pgs. 185-187

### L-25YE Multi-Pro



#### KDS

#### MULTI-PRO 18MM LARGE SCREW-LOCK CUTTER

| CODE   | DESCRIPTION   | BOX QTY | CTN QTY |
|--------|---------------|---------|---------|
| L-25YE | Yellow Carded | 10      | 100     |

- High quality Screw-Lock cutter prevents blade movement
- Multi-purpose metal carpet tucker and staple remover
- High grade Stainless Steel blade slider
- Supplied with super sharp Power Black blade

Suggested replacement blades:

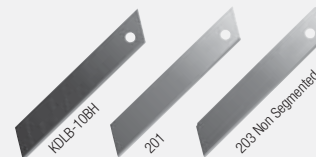

Carded



See pgs. 185-187



## 550 Screw-Lock



### YELLOW 18MM LARGE SCREW-LOCK CUTTER

| CODE         | DESCRIPTION   | BOX QTY | CTN QTY |
|--------------|---------------|---------|---------|
| <b>550-1</b> | Yellow Carded | 12      | 144     |

- The popular traditional Screw-Lock cutter
- Ergonomic body fits all hands comfortably
- Refined mechanism for ease of use
- Supplied with snapper for safe removal of blade segments
- Supplied with 3 blades

Suggested replacement blades:

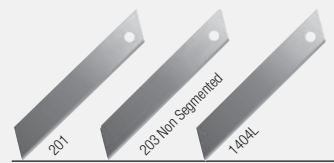

**Carded**



See pgs. 185-187



## Sterling® NT 500

### RED 18MM LARGE SCREW-LOCK CUTTER

| CODE          | DESCRIPTION                                 | BOX QTY | CTN QTY |
|---------------|---|---------|---------|
| <b>500-1</b>  | Red Sterling Carded                         | 12      | 144     |
| <b>L-500P</b> | Red NT Carded                               | 10      | 100     |
| <b>500-B</b>  | Red Sterling Carded with nonsegmented blade | 12      | 144     |

- Original slimline styling
- High quality mechanism for precision blade adjustment
- Supplied with snapper to safely break blunt blade points
- 500-1 with snap-off blade
- 500-B with non-segmented blade

Suggested replacement blades:

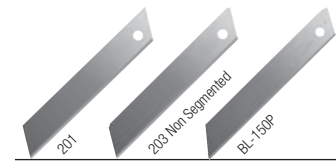

**Carded**



See pgs. 185-187



## 570 Rhino-Grip

### RHINO-GRIP 18MM LARGE SCREW-LOCK CUTTER

| CODE         | DESCRIPTION   | BOX QTY | CTN QTY |
|--------------|---------------|---------|---------|
| <b>570-1</b> | Yellow Carded | 12      | 240     |

- Thick Stainless Steel sleeve for long life
- Rubber grip reduces hands slipping
- Strong Screw-Locking mechanism prevents blade slipping
- Supplied with blade snapper on the back of cutter
- Supplied with 3 blades
- Inbuilt spare blade compartment

Suggested replacement blades:

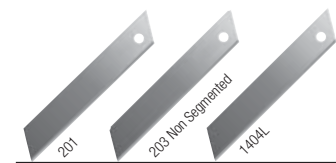

**Carded**



See pgs. 185-187

**Sterling**



680 Zebra

**Sterling**

**ZEBRA 18MM AUTO-LOCK CUTTER**

| CODE         | DESCRIPTION       | BOX QTY | CTN QTY |
|--------------|-------------------|---------|---------|
| <b>680-1</b> | Silver/Red Carded | 12      | 144     |

- Aluminium casing is strong but lightweight
- Rubber hand grip is comfortable and secure
- Strong long lasting Stainless Steel blade slider
- Auto lock blade locking is fast and easy to use

Suggested replacement blades:



**Carded**

See pgs. 185-187



690 All-Metal



**Sterling**

**ALL-METAL 18MM LARGE AUTO-LOCK CUTTER**

| CODE         | DESCRIPTION   | BOX QTY | CTN QTY |
|--------------|---------------|---------|---------|
| <b>690-1</b> | Silver Carded | 12      | 120     |

- Super tough All-Metal die cast body
- Extra thick Stainless Steel insert
- Rubber grip on the back to reduce slippage
- Supplied with blade snapper on the back of cutter

Suggested replacement blades:



**Carded**

See pgs. 185-187





### 625 Snaploader



5 blade Autoload magazine



#### SNAPLOADER 18MM AUTOLOADING CUTTER

| CODE  | DESCRIPTION         | BOX QTY | CTN QTY |
|-------|---------------------|---------|---------|
| 625-1 | Yellow/Black Carded | 12      | 144     |

- Autoloading cutter automatically reloads new blade when old blade is used
- 5 blade magazine makes the hassle of changing blades a thing of the past
- Auto lock and screw lock on nose provides safety and security even on heavy duty applications
- Rubber grip on handle provides comfort and security
- Supplied with 6 blades

Suggested replacement blades:

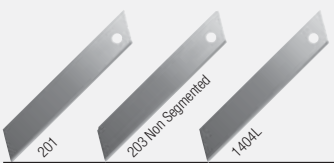

Carded



See pgs. 185-187

### 670 Rhino-Grip



#### RHINO-GRIP 18MM LARGE AUTO-LOCK CUTTER

| CODE  | DESCRIPTION   | BOX QTY | CTN QTY |
|-------|---------------|---------|---------|
| 670-1 | Yellow Carded | 12      | 240     |

- Positive, refined Auto-Lock mechanism won't fail or let the blade slip under pressure
- Thick Stainless Steel sleeve for long life
- Rubber grip reduces hands slipping
- Supplied with blade snapper on the back of cutter
- In-built spare blade compartment
- Supplied with 3 blades

Suggested replacement blades:

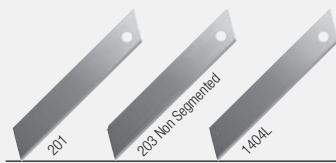

Carded



See pgs. 185-187

*Sterling*

## 655 Autolock



*Sterling*

### AUTOLOCK 18MM LARGE CUTTER

| CODE         | DESCRIPTION   | BOX QTY | CTN QTY |
|--------------|---------------|---------|---------|
| <b>655-1</b> | Yellow Carded | 12      | 144     |

- Autolock blade locking mechanism is convenient and secure
- Sturdy stainless steel sleeve is strong and durable
- 2pcs replacement blades in secure holder inside cutter
- Packed in a display box of 12pcs

Suggested replacement blades:

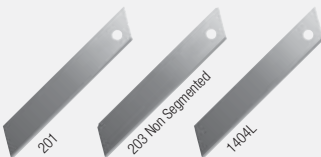

**Carded**



See pgs. 185-187

## 902 Auto-Lock



*Sterling***e**

### YELLOW 18MM LARGE CUTTER

| CODE         | DESCRIPTION   | BOX QTY | CTN QTY |
|--------------|---------------|---------|---------|
| <b>902-1</b> | Yellow Carded | 12      | 240     |

- Auto-Lock mechanism prevents blade slipping
- Popular cutter with blade snapper at rear
- Metal Stainless Steel sleeve for long life

Suggested replacement blades:



**Carded**



See pgs. 185-187



68 Jobber



### JOBBER 18MM LARGE CUTTER

| CODE        | DESCRIPTION    | BOX QTY | CTN QTY |
|-------------|----------------|---------|---------|
| <b>68</b>   | Yellow Polybag | 24      | 240     |
| <b>TH68</b> | Yellow Carded  | 24      | 240     |

- The most popular packaging cutter
- Metal sleeve for long life
- Pull back safety lock stops blade slipping
- Blade snapper at rear to remove used points

Suggested replacement blades:

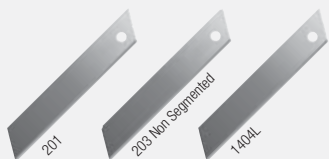

See pgs. 185-187

Carded



Polybag



### 80 All-Plastic

#### ALL-PLASTIC 18MM LARGE CUTTER

| CODE      | DESCRIPTION    | BOX QTY | CTN QTY |
|-----------|----------------|---------|---------|
| <b>80</b> | Yellow Polybag | 24      | 240     |

- 18mm wide all plastic snap-off cutter with pull back safety lock
- Blade snapper at rear to remove used points

Suggested replacement blades:

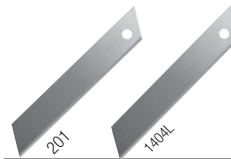

See pgs. 185-187

Polybag



### D-803 Economy

#### ECONOMY 18MM LARGE CUTTER

| CODE          | DESCRIPTION    | BOX QTY | CTN QTY |
|---------------|----------------|---------|---------|
| <b>D-803</b>  | Orange Polybag | 48      | 480     |
| <b>D-803A</b> | Orange Carded  | 24      | 240     |

- Pull back safety lock stops blade slipping
- Blade snapper at rear to remove used points

Suggested replacement blades:

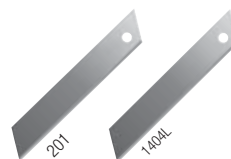

See pgs. 185-187

Carded



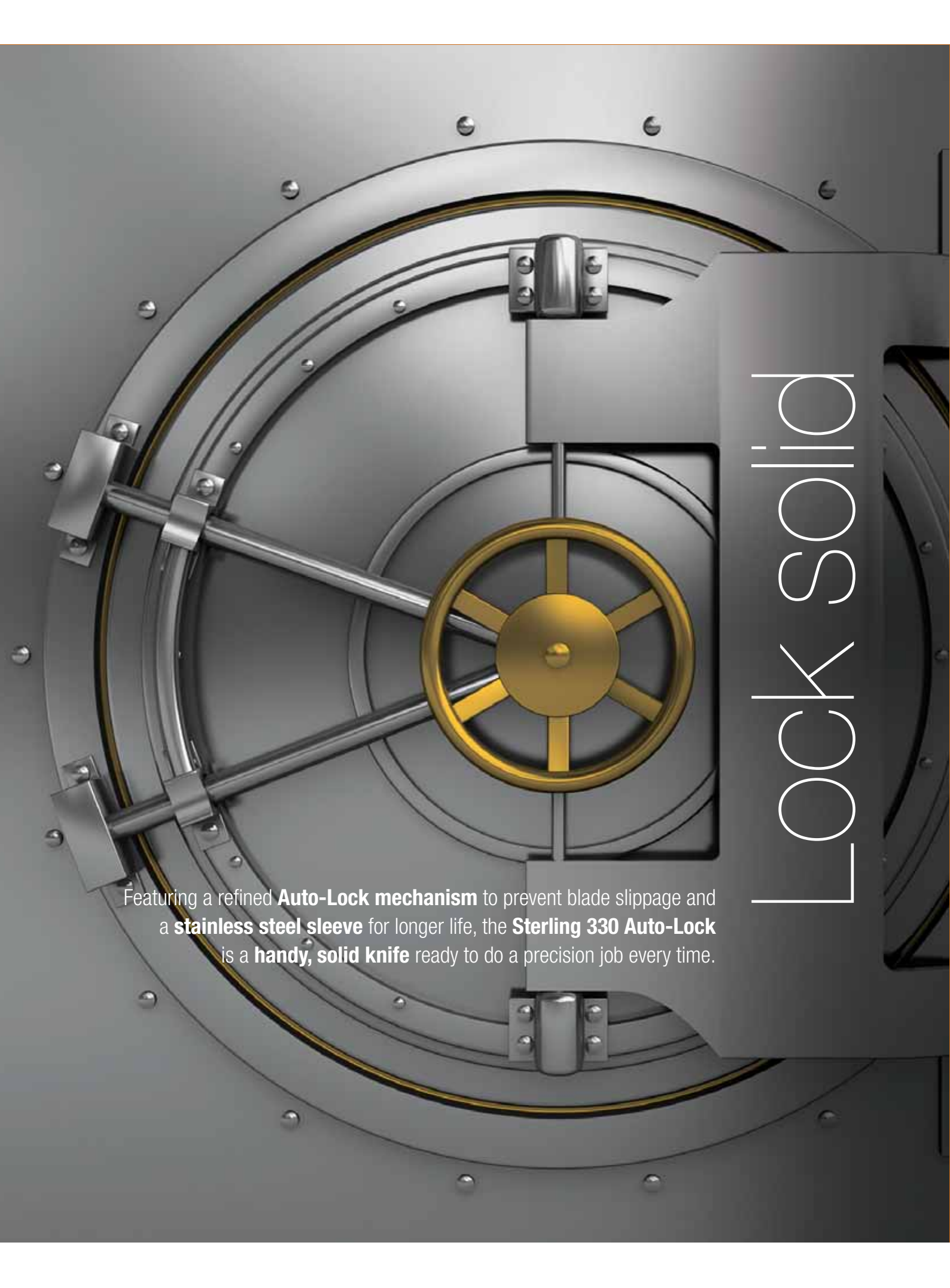

# LOCK SOLID

Featuring a refined **Auto-Lock mechanism** to prevent blade slippage and a **stainless steel sleeve** for longer life, the **Sterling 330 Auto-Lock** is a **handy, solid knife** ready to do a precision job every time.



# 9mm



Stainless steel sleeve

Autolock blade

Easy-Snapper



Spare blades storage in handle

## 330 Auto-Lock

**Sterling**

## 330 Auto-Lock

### AUTO-LOCK 9MM CUTTER

| CODE         | DESCRIPTION   | BOX QTY | CTN QTY |
|--------------|---------------|---------|---------|
| <b>330-1</b> | Yellow Carded | 24      | 600     |

- Stainless Steel sleeve for long life
- Refined Auto-Lock mechanism prevents blade slipping
- Handy pocket clip to keep it in your shirt pocket
- Original style is a favourite with industry
- Replacement blades in knife body
- Supplied with 3 blades
- Metal safety blade snapper for controlled snapping
- Brilliant for Graphic Arts & Tint Film

Suggested replacement blades:

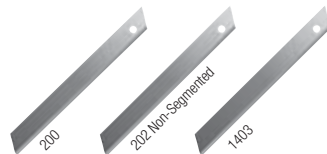

See pgs. 190, 191



Carded

**Sterling**



### 300 Cream



#### CREAM AUTO-LOCK 9MM SMALL CUTTER

| CODE           | DESCRIPTION                  | BOX QTY | CTN QTY |
|----------------|------------------------------|---------|---------|
| <b>A-300</b>   | <i>Sterling</i> Cream Carded | 24      | 600     |
| <b>A-300RP</b> | <i>NT</i> Cream Carded       | 20      | 200     |

- The most popular deluxe cutter
- Refined Auto-Lock mechanism to prevent blade slipping
- Slim design with Stainless Steel sleeve for long life
- Handy pocket clip to keep it in your shirt pocket
- Supplied with 3 blades

Suggested replacement blades:

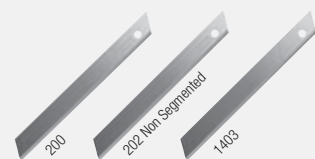

**Carded**



See pgs. 190, 191



### A-300GRP Metal



#### METAL AUTO-LOCK 9MM SMALL CUTTER

| CODE            | DESCRIPTION  | BOX QTY | CTN QTY |
|-----------------|--------------|---------|---------|
| <b>A-300GRP</b> | Metal Carded | 20      | 200     |

- Diecast aluminum for maximum durability
- Refined Auto-Lock mechanism to prevent blade slipping
- Slim design with Stainless Steel sleeve for long life

Suggested replacement blades:

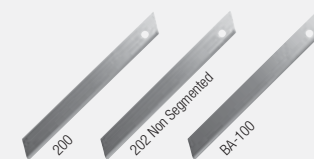

**Carded**



See pgs. 190, 191



### 380 All-Metal



#### ALL-METAL SCREW-LOCK 9MM SMALL CUTTER

| CODE         | DESCRIPTION   | BOX QTY | CTN QTY |
|--------------|---------------|---------|---------|
| <b>380-1</b> | Silver Carded | 24      | 240     |

- Die cast All-Metal construction gives ultimate durability
- Brass Screw-Locking mechanism for extra secure locking
- Ideal for use where solvents are present
- Handy pocket clip to keep it in your shirt pocket

Suggested replacement blades:



**Carded**

See pgs. 190, 191



### 340 All-Metal



#### ALL-METAL AUTO-LOCK 9MM SMALL CUTTER

| CODE         | DESCRIPTION   | BOX QTY | CTN QTY |
|--------------|---------------|---------|---------|
| <b>340-1</b> | Silver Carded | 24      | 240     |

- Auto-Lock mechanism prevents blade slipping
- Die cast All-Metal construction gives ultimate durability
- Stainless Steel sleeve
- Handy clip to keep it in your shirt pocket

Suggested replacement blades:

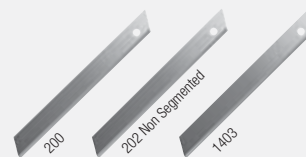

**Carded**

See pgs. 190, 191





## Sterling 220 Black

### BLACK ENAMELED 9MM SMALL CUTTER

| CODE         | DESCRIPTION           | BOX QTY | CTN QTY |
|--------------|-----------------------|---------|---------|
| <b>220-1</b> | Black Enameled Carded | 24      | 600     |

- All steel body for long life
- Original shape supplied with 3 blades
- Blade snapper at rear to remove blunt points

Suggested replacement blades:

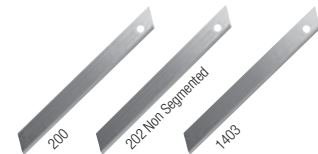

See pgs. 190, 191

Carded



## Sterling 905 Auto-Lock

### AUTO-LOCK 9MM SMALL CUTTER

| CODE         | DESCRIPTION   | BOX QTY | CTN QTY |
|--------------|---------------|---------|---------|
| <b>905-1</b> | Yellow Carded | 12      | 480     |

- Metal sleeve for long life
- Auto-Lock mechanism prevents blade slipping
- Blade snapper at rear to remove blunt points
- Supplied with 3 blades

Suggested replacement blades:

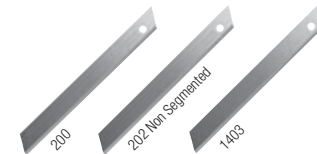

See pgs. 190, 191

Carded



## Sterling 128 Jobber

### JOBBER 9MM SMALL CUTTER

| CODE         | DESCRIPTION    | BOX QTY | CTN QTY |
|--------------|----------------|---------|---------|
| <b>128</b>   | Yellow Polybag | 48      | 480     |
| <b>TH128</b> | Yellow Carded  | 48      | 480     |

- Metal sleeve for long life
- Pull back safety lock stops blade slipping
- Blade snapper at rear to remove blunt points

Suggested replacement blades:

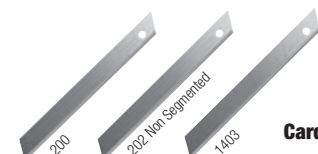

See pgs. 190, 191

Carded

Polybag



## Sterling D-804 Economy

### ECONOMY 9MM SMALL CUTTER

| CODE          | DESCRIPTION    | BOX QTY | CTN QTY |
|---------------|----------------|---------|---------|
| <b>D-804</b>  | Orange Polybag | 48      | 480     |
| <b>D-804A</b> | Orange Carded  | 48      | 240     |

- Economy all plastic cutter
- Pull back safety lock stops blade slipping
- Blade snapper at rear to remove blunt points

Suggested replacement blades:

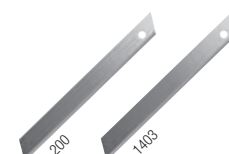

See pgs. 190, 191

Carded

Polybag





## 360 Stainless



### STAINLESS AUTO-LOCK 9MM SMALL CUTTER

| CODE         | DESCRIPTION            | BOX QTY | CTN QTY |
|--------------|------------------------|---------|---------|
| <b>360-1</b> | Stainless Steel Carded | 24      | 600     |

- Slim Stainless Steel body for long life
- Auto-Lock mechanism prevents blade slipping
- Handy pocket clip to keep it in your shirt pocket
- Supplied with 3 blades

Suggested replacement blades:

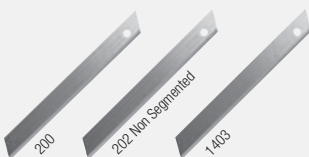

Carded



See pgs. 190, 191

## S-18 Slim-Trim



### KDS

### SLIM-TRIM 9MM SHARP ANGLE SMALL CUTTER

| CODE        | DESCRIPTION   | BOX QTY | CTN QTY |
|-------------|---------------|---------|---------|
| <b>S-18</b> | Silver Carded | 10      | 100     |

- All Stainless Steel Cutter is slim for delicate artwork
- Supplied with sharp angle snap blades
- Will take any 9mm Snap blade

Suggested replacement blades:



Carded



See pg. 190

**If you're all thumbs** then the **Sterling 115 Safety Thumlock knife** is for you!

**Packed with features**, this versatile knife has **automatic blade retraction**, **diecast all metal construction**, **suregrip ribbed body** to prevent slipping and of course, a **Thumlock screw** for safe and easy blade changes.

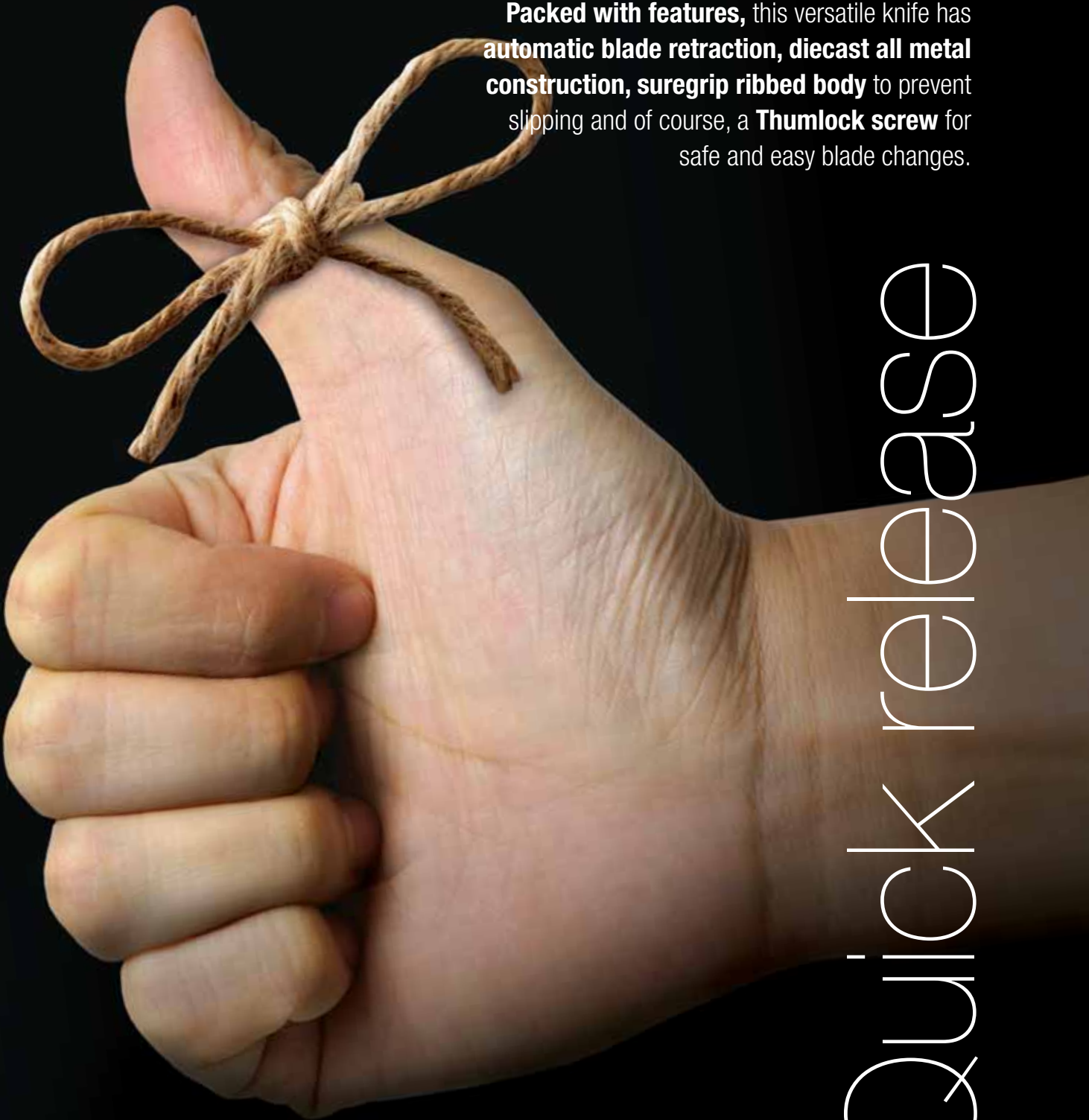

Quick release

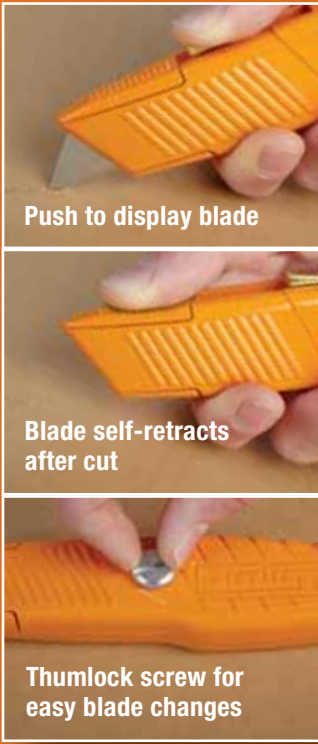

## 115 Safety Thumlock

Self Retracting  
↑



### ULTRA-GRIP SELF RETRACTING KNIFE WITH THUMLOCK QUICK RELEASE SCREW

| CODE            | DESCRIPTION                       | BOX QTY | CTN QTY |
|-----------------|-----------------------------------|---------|---------|
| <b>115-1YRS</b> | Orange Carded with thumlock screw | 6       | 120     |

- Automatic blade retracting system reduces accidents
- Thumlock screw for easy blade changes without tools
- Suitable for both left and right handers
- Die cast all metal construction for maximum strength
- Ribbed body with Suregrip design prevents slipping
- Ultragrip - designed for gloved hands
- Supplied with Safety tip blade

Suggested replacement blades:

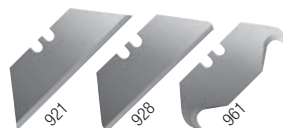

Carded





## Sterling 115 Safety Ultra-Grip

### ULTRA-GRIP SELF RETRACTING KNIFE

| CODE    | DESCRIPTION   | BOX QTY | CTN QTY |
|---------|---------------|---------|---------|
| 115-1YR | Orange Carded | 6       | 120     |

- Automatic blade retracting system reduces injuries
- Suitable for both right and left handers
- Die cast all metal construction for maximum strength
- Ribbed body with Suregrip design to reduce slipping
- Ultragrip - for gloved hands
- Supplied with Safety tip blade

Suggested replacement blades:



See pgs. 175 - 181

Carded



## Sterling 417 Double-Plus

### SAFETY DOUBLE PLUS AUTO RETRACTING SAFETY KNIFE

| CODE  | DESCRIPTION          | BOX QTY | CTN QTY |
|-------|----------------------|---------|---------|
| 417-1 | Silver/Orange Carded | 12      | 144     |

- Automatic self retracting blade system reduces injuries
- Blade still retracts if contact is lost even when slider is still pushed forwards
- Rounded thumb slider can be used from both sides or the top
- Rubberized grip avoids slipping
- Easy blade changes with no tools
- Round point blade protects carton contents

Suggested replacement blades:

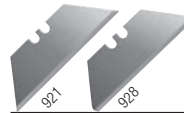

See pgs. 175, 176

Carded



## Sterling 114-2R Rubber Grip

### RUBBER-GRIP SELF RETRACTING KNIFE

| CODE    | DESCRIPTION                      | BOX QTY | CTN QTY |
|---------|----------------------------------|---------|---------|
| 114-2R  | Orange Bulk                      | 20      | 96      |
| 114-2RS | Orange Bulk with thumblock screw | 20      | 96      |

- Automatic blade retracting system reduces injuries
- Suitable for both right and left handers
- Rubber grip sides reduce slipping
- Die cast metal construction

Suggested replacement blades:



See pgs. 175 - 181

Holster See pg. 155



## Sterling 119-1R

### SELF RETRACTING KNIFE

| CODE   | DESCRIPTION   | BOX QTY | CTN QTY |
|--------|---------------|---------|---------|
| 119-1R | Yellow Carded | 12      | 120     |

- Automatic blade retracting system reduces injuries
- Large wrap around button

Suggested replacement blades:



See pgs. 175 - 181

Carded







## 411 Easy Cut



Blade depth Adjuster



Box top guide



Convenient Blade storage



Adjustable for left or right holster



### EASY CUT SELF RETRACTING CUTTER SYSTEM

| CODE          | DESCRIPTION            | BOX QTY | CTN QTY |
|---------------|------------------------|---------|---------|
| <b>411-2</b>  | Yellow/Black Bulk      | 12      | 144     |
| <b>411-1</b>  | Yellow/Black Display   | 12      | 144     |
| <b>411B-2</b> | Dispenser of 80 Blades | 80      |         |
| <b>411B-1</b> | Card of 10 Blades      | 10      |         |

- Cutter, holster, and lanyard system that is easy to use and increases productivity
  - Lanyard prevents cutter being left in packaging – ideal for food applications
  - Automatic blade retracting system
  - Round point blade prevents damage to carton contents
  - Suitable for left and right hand users
  - Easy blade changes without tools
  - Adjustable depth of cut on the blade
  - Built in guide allows top tray cuts
- Replacement blade 411B-2 and 411B-1



Display Box

See pg. 179

## 413 Pocket Cutter



Trigger lock prevents accidental blade exposure



Squeeze yellow trigger and expose blade



Make cut as required



When contact is lost blade retracts even if trigger is still activated



### POCKET CUTTER AUTO RETRACTING SAFETY KNIFE

| CODE         | DESCRIPTION                | BOX QTY | CTN QTY |
|--------------|----------------------------|---------|---------|
| <b>413-1</b> | Black/Yellow 3 pack Carded | 12      | 288     |

- Automatic blade retracting system reduces injuries
- Blade still retracts if contact is lost even when trigger is still activated
- Double action trigger to prevent blade accidentally protruding in your pocket
- Complete knife with non replaceable blade prevents loss of internal parts and unauthorized contact with sharp blade
- High quality blade tested to cut over 1,600 metres of corrugated cardboard
- Plastic body with wear resistant metal skid at blade outlet for durability
- Pocket clip on back to keep cutter handy and prevent misplacement
- Packed in attractive counter display box
- Ideal for retail food packaging areas
- Available packed in convenient retail display

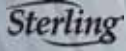

## 416 Longreach



### LONGREACH SELF RETRACTING KNIFE

| CODE         | DESCRIPTION      | BOX QTY | CTN QTY |
|--------------|------------------|---------|---------|
| <b>416-1</b> | Red/Black Carded | 12      | 144     |

- Longest reach of any knife with automatic blade retracting system
- Sturdy metal body for superior strength
- Rubber grip on body is comfortable and prevents slipping
- Suitable for both left and right handers
- Symmetrical design allows blade to be inserted upside down for left hand users.

Replacement blade 416B available:



**Carded**



See pg. 189



## 416-L Longreach Left Handed

### SELF RETRACTING KNIFE - LEFT HAND

| CODE         | DESCRIPTION      | BOX QTY | CTN QTY |
|--------------|------------------|---------|---------|
| <b>416-L</b> | Red/Black Carded | 12      | 144     |

- Longreach knife set up for left handed use - Same features as 416-1.

Replacement blade 416B available:



See pg. 189



## 414 Side-Slider

### SIDE SLIDER SELF RETRACTING KNIFE - RIGHT HAND

| CODE         | DESCRIPTION      | BOX QTY | CTN QTY |
|--------------|------------------|---------|---------|
| <b>414-1</b> | Red/Black Carded | 12      | 120     |

- Automatic blade retracting system to prevent injuries
- Metal body for superior strength
- Rubber grip thumb slider for ease of use

Replacement blade 926-3 available:



**Carded**



See pg. 177



## SK-8 Slide Lever

### AUTO-RETRACTOR AUTOMATIC RETRACTING CARTON OPENER

| CODE        | DESCRIPTION   | BOX QTY | CTN QTY |
|-------------|---------------|---------|---------|
| <b>SK-8</b> | Yellow Carded | 6       | 120     |

- Automatic self retracting blade retracts after cutting even when the blade slider is still pushed forwards
- Very safe with little training required
- Suitable for left and right handed users
- Symmetrical design allows blade to be inserted upside down for left handed users
- Comfort grip rubber hand grip for comfort and safety

Replacement blade SKB-8



## YellowTail

### YELLOWTAIL SELF RETRACTING SAFETY KNIFE

| CODE         | DESCRIPTION   | BOX QTY | CTN QTY |
|--------------|---------------|---------|---------|
| <b>430-1</b> | Yellow Carded | 12      | 144     |

- Split second Automatic blade retracting system to prevent injuries
- Suits both left and right hand users
- Unique shape aids knife grip

Replacement blade 430B-4 available:



**Carded**



See pg. 215



## 412 Side-Slide



### SIDE-SLIDE SELF RETRACTING KNIFE

| CODE         | DESCRIPTION   | BOX QTY | CTN QTY |
|--------------|---------------|---------|---------|
| <b>412-1</b> | Yellow Carded | 10      | 100     |

- Automatic blade retracting system prevents injuries
- Suits both right and left handers
- Symmetrical design allows blade to be inserted upside down for left handed users

Replacement blade 412B available:



**Carded**



See pg. 179



## 412-L Side-Slide Left Handed

### SELF RETRACTING KNIFE - LEFT HAND

| CODE         | DESCRIPTION                                  | BOX QTY | CTN QTY |
|--------------|--|---------|---------|
| <b>412-L</b> | Yellow Carded - Set up for left handed users | 10      | 100     |

- Automatic blade retracting system prevents injuries
- Suits both right and left handers
- Symmetrical design allows blade to be inserted upside down for right handed users

Replacement blade 412B available:



See pg. 179



## SK-6

### AUTOMATIC RETRACTING BLADE CARTON OPENER

| CODE        | DESCRIPTION   | BOX QTY | CTN QTY |
|-------------|---------------|---------|---------|
| <b>SK-6</b> | Yellow Carded | 6       | 120     |

- Self retracting blade cutter with Auto-Guard System
- Auto-Guard automatically springs forward to cover blade when edge contact is lost
- Suitable for left and right hand users
- Round point blade to prevent damage to carton contents

Replacement blade RSKB-2 available:



## Allway SRK-B6 Slide Lever

### SAFETY KNIFE

| CODE          | DESCRIPTION | BOX QTY | CTN QTY |
|---------------|-------------|---------|---------|
| <b>SRK-B6</b> | Orange Bulk | 12      | 144     |

- Automatic blade retracting system to prevent injuries
- Metal body for superior strength
- Suitable for left and right handed use
- Limited depth of cut and round point blade to prevent damage to carton contents
- Easy blade changes without tools
- Spare blade stores inside knife
- Supplied with Round Point safety blades

Replacement blades for SRK-B6 & SRK-B6L: Sharp Point 9210-3, Round Point K855



See pg. 177



## Allway SRK-B6L Left Handed Slide Lever

### SAFETY KNIFE

| CODE           | DESCRIPTION | BOX QTY | CTN QTY |
|----------------|-------------|---------|---------|
| <b>SRK-B6L</b> | Orange Bulk | 12      | 144     |

- Same knife as above can be used as a left handed knife - Features as above

Replacement blades for SRK-B6 & SRK-B6L: Sharp Point 9210-3, Round Point K855

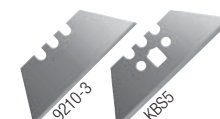

See pg. 177

Sterling



## Sterling 415 Junior-Slide

### JUNIOR SELF RETRACTING KNIFE

| CODE | DESCRIPTION | BOX QTY | CTN QTY |
|------|-------------|---------|---------|
| 415  | Yellow Bulk | 24      | 600     |

- Automatic blade retracting system to prevent injury
- Light weight plastic knife is disposable
- Suitable for both right and left handers

Replacement blade 922-3



See pg. 177



## Sterling 500 Non-Segmented

### NON-SEGMENTED 18MM SCREW-LOCK CUTTER

| CODE  | DESCRIPTION             | BOX QTY | CTN QTY |
|-------|-------------------------|---------|---------|
| 500-B | Red Carded Nonsegmented | 12      | 144     |

- Supplied with Non-Segmented blade
- Eliminates danger from broken blade segments
- Suitable for food packaging applications

Replacement blade 203-4



See pg. 187



SL-1P

NT



SL-1P

### NT SELF RETRACTING SAFETY CUTTER

| CODE    | DESCRIPTION                     | BOX QTY | CTN QTY |
|---------|---------------------------------|---------|---------|
| SL-1P   | Red Carded                      | 12      | 120     |
| BSL-11P | Replacement Blades (Tube of 10) | 10      | 100     |

- Unique self retracting cutter with snap off blades
- Automatic blade retracting system prevents injuries

Replacement blade BSL-11P



See pg. 189

Carded



100R Mica



**Sterling** 100R Mica

**SELF RETRACTING CARTON OPENER KNIFE**

| CODE        | DESCRIPTION | BOX QTY | CTN QTY |
|-------------|-------------|---------|---------|
| <b>100R</b> | White Boxed | 100     | 500     |

- Automatic blade retracting system prevents injury
- Light weight design with 4 edged blade
- Suitable for right and left handed users
- Limited depth of cut with rounded edge blade protects carton contents
- Suitable for cutting seat belts, film, shrink wrap, bubble wrap and plastic strapping etc.

Replacement blade 451-040R, 451-040



See pg. 214



## 16 Touch Knife

**TOUCH KNIFE WITH KEY RING**

| CODE      | DESCRIPTION | BOX QTY | CTN QTY |
|-----------|-------------|---------|---------|
| <b>16</b> | Yellow Bulk | 120     | 2400    |

- Automatic spring loaded blade return
- Convenient pocket knife with self retracting blade
- Ideal promotional product



## Allway SSK

**ALLWAY CONTROLLED DEPTH SAFETY KNIFE**

| CODE       | DESCRIPTION   | BOX QTY | CTN QTY |
|------------|---------------|---------|---------|
| <b>SSK</b> | Orange carded | 12      | 144     |

- Automatic blade retracting system prevents injury
- Metal body for superior strength
- Cutting depth can be controlled and set at 4mm, 10mm, 16mm and 24mm maximum depth to suit specific scoring or cutting tasks to prevent damage to contents
- Large comfortable thumb slider suits right and left hand users

Replacement blades: Sharp Point 9210-3; Round Point KBS5

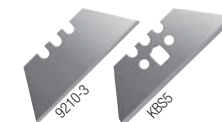

See pg. 177



**Carded**

Sterling



## Sterling® 100 Silver

### SILVER CARTON OPENER WITH SLIDING BLADE COVER

| CODE       | DESCRIPTION | BOX QTY | CTN QTY |
|------------|-------------|---------|---------|
| <b>100</b> | Silver Bulk | 12      | 600     |

- Has limited depth of cut to protect carton contents

Replacement blade 30-112



See pg. 193



## Sterling® 418 Protector

### PROTECTOR FIXED KNIFE WITH SAFETY PIN

| CODE         | DESCRIPTION      | BOX QTY | CTN QTY |
|--------------|------------------|---------|---------|
| <b>418-1</b> | Black/Red Carded | 12      | 120     |

- Blade edge protected by spring loaded safety pin when not in use or if cutting edge contact is lost
- Strong handle made from diecast metal
- Easy blade change without tools
- Blade cover can turn around when not in use for additional storage safety
- 4 edge blade lasts twice as long
- Both square cornered or round cornered blade available

Replacement blade 451-040R, 451-040

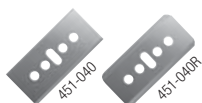

Carded



See pg. 214

100B Metal



Sterling®

### METAL CARTON OPENER WITH SLIDING BLADE COVER

| CODE        | DESCRIPTION | BOX QTY | CTN QTY |
|-------------|-------------|---------|---------|
| <b>100B</b> | Brass Bulk  | 24      | 600     |

- Blade has rounded edges to protect carton contents
- Has limited depth of cut to protect carton contents

Replacement blade 471-040R



See pg. 214

## 441 Tusk II



Sterling®

### TUSK II ENCLOSED BLADE CARTON OPENER

| CODE  | DESCRIPTION      | BOX QTY | CTN QTY |
|-------|------------------|---------|---------|
| 441-1 | Red/Black Carded | 12      | 144     |

- Super Sharp circular blade cuts most packaging materials
- Big grip and sturdy body for demanding applications
- Rubber grip handle is comfortable and prevents slipping
- Tape splitter on back of cutter allows safe opening of cartons
- Easy blade changes without tools

Replacement blade RB-03



Carded



See pg. 207



## Sterling® 440 Tusk

### TUSK ENCLOSED BLADE CARTON OPENER

| CODE  | DESCRIPTION         | BOX QTY | CTN QTY |
|-------|---------------------|---------|---------|
| 440-1 | Yellow/Black Carded | 6       | 80      |

- Rubber grip handle is comfortable and prevents slipping
- Tape splitter on back of cutter allows for safe opening of cartons
- Easy blade changes, no tools required
- Suitable for cutting seatbelts, film, shrink wrap, bubble wrap and plastic strapping

Replacement blade 420-4



Carded

See pg. 211



Sterling®

## 442 Tough-Tusk

### TOUGH TUSK ENCLOSED BLADE CARTON CUTTER

| CODE  | DESCRIPTION         | BOX QTY | CTN QTY |
|-------|---------------------|---------|---------|
| 442-1 | Silver/Black Carded | 12      | 120     |

- Heavy duty metal body for tough tasks
- Twin blades for easy cutting
- Suitable for cutting seatbelts, film, shrink wrap, bubble wrap and plastic strapping
- Rubber grip handle is comfortable and prevents slipping

Replacement blade TH82B



Carded







## Sterling<sup>e</sup> 320 Blue

### ENCLOSED BLADE CUTTER SAFETY CUTTER

| CODE       | DESCRIPTION | BOX QTY | CTN QTY |
|------------|-------------|---------|---------|
| <b>320</b> | Blue Bulk   | 12      | 720     |

- Suitable for stretch wrap, twine and tape
- Replaceable Blades

Replacement blade 70-1102



See pg. 215



## Sterling<sup>e</sup> 350 White

### ENCLOSED BLADE WHITE SAFETY CUTTER

| CODE       | DESCRIPTION | BOX QTY | CTN QTY |
|------------|-------------|---------|---------|
| <b>350</b> | White Bulk  | 12      | 720     |

- Suitable for cutting plastic film and stretch wrap
- Replaceable blade

Replacement blade 70-1102



See pg. 215



## Sterling<sup>e</sup> 82 Twin-Blade

### TWIN BLADE CARTON OPENER WITH SAFETY CAP

| CODE         | DESCRIPTION             | BOX QTY | CTN QTY |
|--------------|-------------------------|---------|---------|
| <b>82</b>    | Black boxed             | 36      | 600     |
| <b>TH82B</b> | Replacement Blade (x10) | 24      | 600     |

- Wider blade opening for thicker materials
- Double blade system for higher capacity cutting

Replacement blade TH82B



## Sterling<sup>®</sup> 326 Safe Edge

### KLEVER TYPE SAFE EDGE CUTTER

| CODE         | DESCRIPTION | BOX QTY | CTN QTY |
|--------------|-------------|---------|---------|
| <b>326-2</b> | Black Bulk  | 100     | 500     |

- Enclosed Blade Safety Cutter
- Tips can be used as a tape cutter
- Unique shape prevents damage to carton contents
- Light, Safe, easy to use and disposable

## 325 Green Slitter



### GREEN SLITTER ENCLOSED BLADE - HEAVY DUTY

| CODE       | DESCRIPTION | BOX QTY | CTN QTY |
|------------|-------------|---------|---------|
| <b>325</b> | Green Bulk  | 50      | 1500    |

- Ergonomic cutter with finger hole to prevent slipping
- Ideal for opening cartons, slitting film, bubble wrap, tape and cutting seatbelts
- Disposable to prevent contact with blade



Tape slitter and cutter on one action



## 98 Safety Slitter

### SAFETY SLITTER ENCLOSED BLADE LETTER OPENER

| CODE      | DESCRIPTION | BOX QTY | CTN QTY |
|-----------|-------------|---------|---------|
| <b>98</b> | White Bulk  | 24      | 2880    |

- Economical safety slitter
- Slitting film, tape, and paper
- Disposable to prevent contact with blade



## 470 Superslit II

### SUPERSLIT II ENCLOSED BLADE SAFETY SLITTER

| CODE         | DESCRIPTION      | BOX QTY | CTN QTY |
|--------------|------------------|---------|---------|
| <b>470-1</b> | Black/Red Carded | 12      | 120     |

- Heavy duty model with metal foot
- Integrated guide prevents blade contact and holds down material ahead of blade
- Cuts all types of plastic sheet, fabric, and leather
- Easy blade change

Takes blade 80-020



**Carded**





## Sterling® 446 Super Safe Top

### SUPER SAFE TOP CUTTER

| CODE  | DESCRIPTION  | BOX QTY | CTN QTY |
|-------|--------------|---------|---------|
| 446-2 | Silver boxed | 1       | 144     |

- Spring safety blade guard
- Specially designed for cutting the tops off cartons safely
- Adjustable depth of cut to prevent damage to carton contents
- Ideal for large scale carton opening



## F200 Fish

### SAFETY KNIFE FISH200

| CODE                | DESCRIPTION                 | BOX QTY | CTN QTY |
|---------------------|-----------------------------|---------|---------|
| F200                | Red Bulk                    | 12      |         |
| Replacement Blades: |                             |         |         |
| F200B               | Straight Blade - tube of 10 | 1       |         |
| F200H               | Hook Blade - tube of 10     | 1       |         |

- Replaceable blade available
- Hooked blade at rear for cutting rope, strap, twine etc



## 445 RESQ



Carded



### RESQ EMERGENCY SAFETY HAMMER

| CODE  | DESCRIPTION      | BOX QTY | CTN QTY |
|-------|------------------|---------|---------|
| 445-1 | Red/Black Carded | 12      | 120     |

- Vehicle emergency safety tool that includes:
  - Steel tipped window punch that shatters tempered glass
- Flat round steel tipped hammer to open up shattered glass for escape
- Ultra sharp serrated razor blade that safely slices through seat belts
- Rubber handle for superior grip
- LED emergency light to assist safe escape at night or low light situations



With a **100% stainless steel construction**, the **Sterling 3044 knife** is perfect for both the **food and general industries**. It's easily cleaned, folds down to compact size and also **comes with a handy Nylon holster!**



Clean & efficient



100% Stainless Steel



Folds down for safe storage



Comes with holster

3044 Stainless



*Sterling*<sup>®</sup>

**STAINLESS STEEL POCKET KNIFE**

| CODE        | DESCRIPTION   | BOX QTY | CTN QTY |
|-------------|---------------|---------|---------|
| <b>3044</b> | Silver Carded | 12      | 120     |

- 100% Stainless Steel Construction
- Blade length 80mm
- Ideal for food industry and general industry
- Supplied with Nylon holster



Carded



Holster

misso

53

MISCELLANEOUS TOOLS & KNIVES

*Sterling*<sup>®</sup>

## 58-546 Lunar Knife



### LUNAR HIGH QUALITY WORK KNIFE

| CODE          | DESCRIPTION    | BOX QTY | CTN QTY |
|---------------|----------------|---------|---------|
| <b>58-546</b> | Blue Bulk - 8" | 10      | 200     |

- Stainless Steel blade and moulded plastic handle
- Blue handle for easy identification in food industry
- Suitable for the food & mining industries
- Supplied with plastic holster



Comes with Plastic Holster

## 58-151P ROE



Rounded Tip



### ROE 7" WORK KNIFE

| CODE           | DESCRIPTION    | BOX QTY | CTN QTY |
|----------------|----------------|---------|---------|
| <b>58-151P</b> | Blue Bulk - 7" | 10      | 250     |

- Safety tip on blade point to prevent stab injury
- Plastic handle with Stainless Steel blade
- Supplied in plastic holder
- Suitable for the food industry



Comes with Plastic Holster



## 802 Boot Knife

### BOOT KNIFE WITH WOODEN HANDLE

| CODE       | DESCRIPTION                | BOX QTY | CTN QTY |
|------------|----------------------------|---------|---------|
| <b>802</b> | Stainless Steel Boxed - 8" | 12      | 240     |
| <b>803</b> | Carbon Steel Bulk - 8"     | 12      | 300     |

Leather holster available Code BTC35. *See pg. 157*

- Sturdy construction with 2 brass rivets
- Ground blade for superior durability
- Code 802 with Stainless Steel blade
- Code 803 with carbon steel blade

**Available with Leather Holster**

*See pg. 155*



## 804 Plastic Handle

### BOOT KNIFE WITH PLASTIC HANDLE

| CODE         | DESCRIPTION                    | BOX QTY | CTN QTY |
|--------------|--------------------------------|---------|---------|
| <b>804</b>   | Blue Bulk - 8"                 | 20      | 200     |
| <b>804H*</b> | With Plastic Holster Bulk - 8" | 10      | 200     |

- Stainless Steel blade
- Suitable for the food industry
- Available with plastic holster (804H)\*

**Available with Plastic Holster**



## RC-11 Bando Knife



Sterling®

### BANDO KNIFE

| CODE         | DESCRIPTION | BOX QTY | CTN QTY |
|--------------|-------------|---------|---------|
| <b>RC-11</b> | Bulk        | 50      | 200     |

- Bando / Barnsley style knife for cutting and splicing rubber belting
- Timber handle with 3 rivets
- Overall length 210mm
- Made in Sheffield England



## 58-120 Sharp Point

### THROWAWAY KNIFE

| CODE          | DESCRIPTION | BOX QTY | CTN QTY |
|---------------|-------------|---------|---------|
| <b>58-120</b> | Yellow Bulk | 100     | 2000    |

- Replaceable cap with pocket clip
- Hi Vis yellow
- Disposable blade and handle

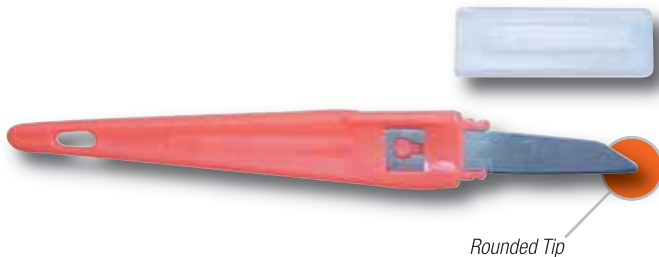

## 58-120R Safety Tip

### SAFETY TIP THROWAWAY KNIFE

| CODE           | DESCRIPTION | BOX QTY | CTN QTY |
|----------------|-------------|---------|---------|
| <b>58-120R</b> | Orange Bulk | 100     | 2000    |

- Rounded tip blade to prevent stab wounds
- Replaceable cap with pocket clip
- Hi Vis safety orange
- Disposable blade and handle

## Glass Edge Safety Trimmer



### GLASS EDGE SAFETY TRIMMER

| CODE         | DESCRIPTION                          | BOX QTY | CTN QTY |
|--------------|--------------------------------------|---------|---------|
| <b>448-2</b> | Bulk Black                           | 1       | 100     |
| <b>210-4</b> | 12mm Replacement Blades - Tube of 10 | 10      | 200     |

- Specialist tool for safely trimming plastic laminate off the edge of laminated glass
- Wide mouth allows for a full range of glass thicknesses up to 20mm
- Angled side to allow for curved or beveled glass
- 9 adjustable blade positions for longer blade life

Replacement blade 210-4.







## Sterling® 3088 Pocket Knife

### FOLDING WITH SAFETY LOCK

| CODE        | DESCRIPTION  | BOX QTY | CTN QTY |
|-------------|--------------|---------|---------|
| <b>3088</b> | Black Carded | 12      | 240     |

Replacement blade 3088B. See pg. 205

- Secure blade lock
- Replaceable Stainless Steel blade



## Sterling® 805-1 Hacking Knife

| CODE         | DESCRIPTION  | BOX QTY | CTN QTY |
|--------------|--------------|---------|---------|
| <b>805-1</b> | Black carded | 12      | 120     |

- Extra heavy duty 5mm thick blade
- Riveted leather handle
- 210mm overall length
- Used in the Air Conditioning industry, glazing and other industries

Carded



## Multi Sharpener



### MULTI SHARPENER

| CODE          | DESCRIPTION | BOX QTY | CTN QTY |
|---------------|-------------|---------|---------|
| <b>JH-010</b> | Blue Carded | 20      | 240     |

- One side Sharpening Stone insert
- One side Whet Stone insert
- Supplied with PVC pouch
- Sharpens knives, scissors, garden tools etc.

Carded





## 3056 Multi-Pro

*Sterling*

Carded



### MULTI-PRO 12 FUNCTION MULTI-PURPOSE TOOL

| CODE        | DESCRIPTION       | BOX QTY | CTN QTY |
|-------------|-------------------|---------|---------|
| <b>3056</b> | Blue Combo Carded | 6       | 96      |

- High quality Stainless Steel tools
- Rubber grip inserts
- Supplied with nylon pouch
- Suitable for industry, fishing, sports and promotional gifts
- Closed size 95 x 38 x 19mm



Display box of 6



## 3005S Slimline

### 6 FUNCTION POCKET KNIFE

| CODE         | DESCRIPTION | BOX QTY | CTN QTY |
|--------------|-------------|---------|---------|
| <b>3005S</b> | Silver Bulk | 12      | 240     |

- 100% Stainless Steel
- Supplied with key ring
- Size 70 x 20 x 8mm
- Ideal for promotional purposes

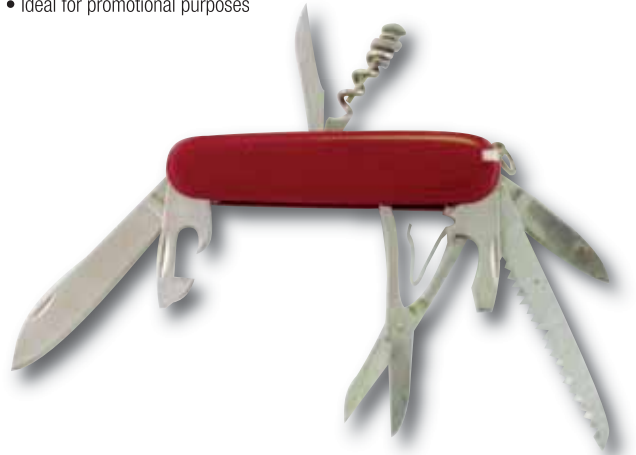

## *Sterling* 3066 Pocket Knife

### 8 FUNCTION POCKET KNIFE

| CODE        | DESCRIPTION | BOX QTY | CTN QTY |
|-------------|-------------|---------|---------|
| <b>3066</b> | Red Bulk    | 10      | 240     |

- Supplied with nylon pouch
- Size 90 x 20 x 17mm
- Ideal promotional product



## Sterling® 3099 Riggers Knife

### RIGGERS KNIFE

| CODE | DESCRIPTION  | BOX QTY | CTN QTY |
|------|--------------|---------|---------|
| 3099 | Silver Boxed | 10      | 100     |

- 100% Stainless Steel
- Includes bottle opener and splicer
- Ideal for Boating & Mining Industries
- Leather Holster available

Holster RTC25



## Sterling® TC-11 Tube Cutter

### TUBE CUTTER WITH REPLACEABLE BLADE

| CODE  | DESCRIPTION | BOX QTY | CTN QTY |
|-------|-------------|---------|---------|
| TC-11 | Red Carded  | 10      | 400     |

- Cuts up to 12mm (1/2") plastic tube and hose
- Easy and safe to use

Replacement blade B-39. See pg. 213

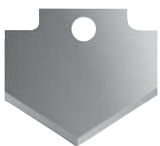

Carded



## BLR Blade Disposal Bins



BLR-B  
Blademate



Carded

## Sterling®

### PLASTIC BLADE SAFETY DISPOSAL BINS

| CODE  | DESCRIPTION                                       | BOX QTY | CTN QTY |
|-------|---|---------|---------|
| BLR-B | BLADEMATE Sharps Container with Belt Clip - 0.15L | 1       | 60      |
| BLR-1 | 0.5L 1kg Sharps Bin                               | 1       | 60      |
| BLR-2 | 2L 2kg Sharps Bin                                 | 1       | 48      |
| BLR-5 | 5L 5kg Sharps Bin                                 | 1       | 36      |

- Safe disposal of used blades
- Sealable for safe handling



BLR-1  
0.5L 1kg Sharps Bin



BLR-5  
5L 5kg Sharps Bin

Watch out for this savage Sterling saw! Featuring hardened teeth, triple edge shark tooth grinding, sharpened tip for job starts and an ergonomic rubber grip handle the Sterling T-Rex 50-660 Drywall saw is sharp & savage and ready to rip right into the job at hand! Rooaaaaawwwrrrr!



Sharp & savage

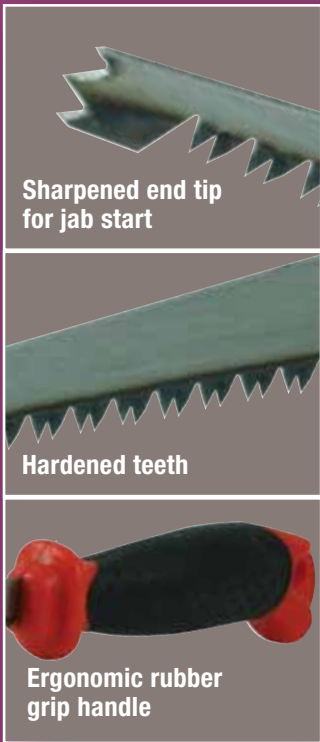

Sharpened end tip  
for job start

Hardened teeth

Ergonomic rubber  
grip handle

# 50-660 T-Rex Drywall



*Sterling*<sup>®</sup>

### T-REX 6" DRYWALL SAW

| CODE   | DESCRIPTION        | BOX QTY | CTN QTY |
|--------|--------------------|---------|---------|
| 50-660 | Drywall Saw Carded | 10      | 250     |

- Hardened teeth keyhole saw
- Triple edge grinding cuts forwards & backwards
- Ergonomic rubber grip handle
- Sharpened and hardened triple point tip for easy job starting



Carded

*Sterling*<sup>®</sup>

SAWS

61

SAWS

## 50-770 T-Rex Saw



Sleeve Cover



### T-REX 550MM (22") HARDPOINT HANDSAW

| CODE   | DESCRIPTION           | BOX QTY | CTN QTY |
|--------|-----------------------|---------|---------|
| 50-770 | Red/Black Display Box | 24      | 24      |

- 550mm (22") 8TPI Handsaw with triple ground shark point teeth for fast cuts even in hardwood
- Hardened teeth are durable and will cut a wide range of materials including timber, laminated boards, plastic pipe, plasterboard, cornices, etc.
- Rubber grip handle is comfortable, secure, and has 90° and 45° angles for accurate marking out
- Packed in an excellent floor standing display box to promote impulse buying



Display

## 16003 Versa Saw



Carded



### boa

#### VERSA SAW BOA RESTRICTED ACCESS SAW PLASTIC HANDLE

| CODE  | DESCRIPTION | BOX QTY | CTN QTY |
|-------|-------------|---------|---------|
| 16003 | Carded      | 50      | 50      |

- Plastic Handle
- Spring Loaded Blade Stabilizing Bar
- Easy blade replacement



16004 Versa Saw

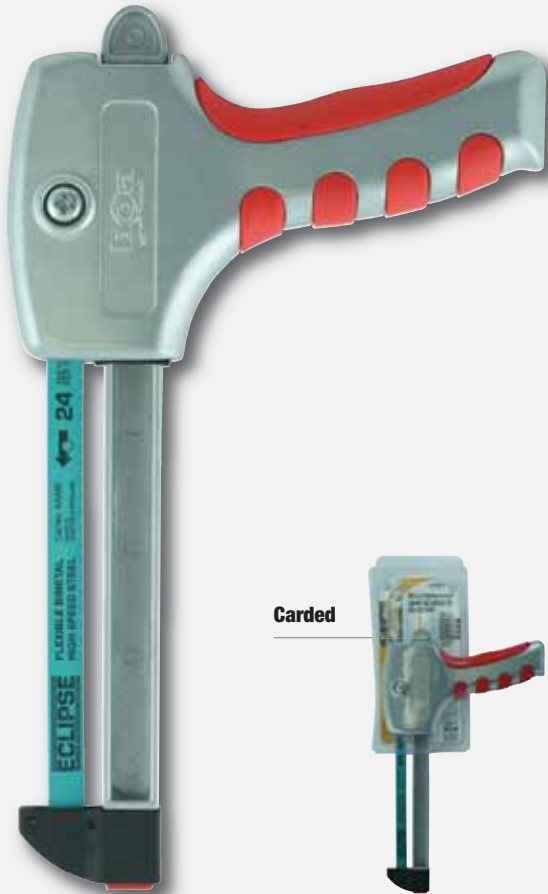

Carded



boa

VERSA SAW BOA RESTRICTED ACCESS SAW ALUMINIUM HANDLE

| CODE  | DESCRIPTION | BOX QTY | CTN QTY |
|-------|-------------|---------|---------|
| 16004 | Carded      | 50      | 50      |

- Strong Aluminum Construction
- Spring Loaded Blade Stabilizing Bar
- Easy blade replacement\*



Sterling® HF-40T  
Rhino-Grip

RHINO-GRIP COMPOSITE HACKSAW FRAME

| CODE   | DESCRIPTION | BOX QTY | CTN QTY |
|--------|-------------|---------|---------|
| HF-40T | Red Carded  | 6       | 48      |

Replacement blades No. 300-18, 300-24, 300-32. See pgs. 171-172

- High quality rubber grip frame with steel core
- High tension frame with quick release blade holder
- 90° and 45° blade positions
- Made in France

Carded



Sterling® HF-506  
Trade-Tough

TRADE-TOUGH ALUMINIUM HACKSAW FRAME

| CODE   | DESCRIPTION   | BOX QTY | CTN QTY |
|--------|---------------|---------|---------|
| HF-506 | Yellow Carded | 6       | 36      |

- Strong, light aluminium box section frame
- Tension screw holds blade tightly
- Rubber grip handle
- Spare blade storage in top section

Carded



**Striker!** The name says it all! **Drop forged for extra strength and with a comfortable cushion grip, the Sterling Striker HX-520 hammer** is an **excellently balanced hammer** that makes hammering easier, so you can **hammer longer**.



Drop forged for extra strength



Cushion grip rubber handle



Excellently balanced for superior control

Forged

*Sterling*<sup>®</sup>





HX-520 Striker

*Sterling*<sup>®</sup>

**STRIKER 20oz STERLING CLAW HAMMER**

| CODE          | DESCRIPTION      | BOX QTY | CTN QTY |
|---------------|------------------|---------|---------|
| <b>HX-520</b> | Red/Black Carded | 6       | 24      |

- Drop forged for extra strength
- Cushion grip rubber handle
- Excellently balanced for superior control



Hangpack



*Sterling*<sup>e</sup>

HC-024 24oz

**FIBREGLASS 24oz CLAW HAMMER**

| CODE          | DESCRIPTION         | BOX QTY | CTN QTY |
|---------------|---------------------|---------|---------|
| <b>HC-024</b> | Yellow/Black Carded | 6       | 24      |

- Rubber grip handle
- Forged head
- Strong fibreglass handle to reduce vibration



*Sterling*<sup>e</sup>

HC-020 20oz

**FIBREGLASS 20oz CLAW HAMMER**

| CODE          | DESCRIPTION      | BOX QTY | CTN QTY |
|---------------|------------------|---------|---------|
| <b>HC-020</b> | Red/Black Carded | 6       | 24      |

- Rubber grip handle
- Forged head
- Strong fibreglass handle to reduce vibration



# High performance

The **Sterling 14-137 Carpet knife** is made from **high grade stainless steel** for **rigidity and durability** and has a **super keen ground edge for easy resharpening**, so you can go over piles of carpet before you need a re-sharpen.



# 14-137 Carpet Knife



**Sterling**

**CURVED CARPET KNIFE**

| CODE          | DESCRIPTION | BOX QTY | CTN QTY |
|---------------|-------------|---------|---------|
| <b>14-137</b> | Blue Carded | 12      | 300     |

- Traditional style carpet knife
- High Grade Stainless Steel blade for rigidity & durability
- Super keen edge grinding for easy re-sharpening
- Hardwood handle

**Sterling**



Carded

flooring

67

FLOORING & CARPET TOOLS

## NKS-9 1/4 Moon



*Sterling*

### 1/4" MOON KNIFE

| CODE         | DESCRIPTION | BOX QTY | CTN QTY |
|--------------|-------------|---------|---------|
| <b>NKS-9</b> | Bulk        | 12      | 120     |

- Tempered High Carbon Steel blade for superior durability
- Riveted hardwood handle
- Made in Sheffield England

## 14-132 Rubbergrip Lino



*Sterling*

### RUBBERGRIP LINO KNIFE

| CODE          | DESCRIPTION | BOX QTY | CTN QTY |
|---------------|-------------|---------|---------|
| <b>14-132</b> | Carded      | 24      | 48      |

- Fully ground Stainless Steel blade
- Contoured rubber grip handle for secure grip
- Stiff sturdy blade ideal for tucking



**Carded**



*Sterling* 14-134 Lino

**HARDWOOD HANDLE LINO KNIFE**

| CODE   | DESCRIPTION | BOX QTY | CTN QTY |
|--------|-------------|---------|---------|
| 14-134 | Carded      | 12      | 240     |

- Stainless Steel blade
- Contoured hardwood handle for superior grip



Carded



*Sterling* 18-092 Cushion

**CUSHION GRIP STAIR TOOL**

| CODE   | DESCRIPTION | BOX QTY | CTN QTY |
|--------|-------------|---------|---------|
| 18-092 | Carded      | 1       | 1       |

- Chrome plated to prevent markings to skirting and carpet
- Comfortable heavy duty cushion grip
- Solid forged construction



Carded



18-095 T-Type

*Sterling*

**T-TYPE STAIR TOOL**

| CODE   | DESCRIPTION | BOX QTY | CTN QTY |
|--------|-------------|---------|---------|
| 18-095 | Carded      | 6       | 24      |

- Ideal for tucking carpet in confined spaces
- Chrome plated steel to prevent marking skirting boards and carpets
- Solid forged construction



Carded



Carded



## Sterling® 18-070 Wall Trimmer

### WALL TRIMMER

| CODE            | DESCRIPTION                   | BOX QTY | CTN QTY |
|-----------------|-------------------------------|---------|---------|
| <b>18-070</b>   | Carded                        | 1       | 1       |
| <b>18-070WR</b> | Replacement nylon wall runner | 1       | 1       |

Replacement blade code 941. *See pg. 178*

- Adjustable wall runner covered in non-marking material
- Supplied with 6 shims to adjust for carpet thicknesses
- Takes two 941 trimmer blades
- Adjustable handle to allow for cutting under kick boards
- Replacement non-marking nylon wall runner available



Carded



## Sterling® 18-420 Cushion Back Cutter

### CUSHION BACK CUTTER

| CODE          | DESCRIPTION   | BOX QTY | CTN QTY |
|---------------|---------------|---------|---------|
| <b>18-420</b> | Silver Carded | 1       | 36      |

Replacement blade code 40-101. *See pg. 212*

- Narrow foot and guide to follow carpet rows
- Twin blade design to cut close to carpet pile on each side



Carded



## Sterling® 18-001 Foam Back Cutter

### BLUE FOAM BACK CARPET CUTTER

| CODE          | DESCRIPTION | BOX QTY | CTN QTY |
|---------------|-------------|---------|---------|
| <b>18-001</b> | Blue Carded | 1       | 1       |

Replacement blade code 915 or 40-101. *See pg. 178*

- Takes 2 hole trimmer blade for cutting foam back carpets
- Can also be used as a row cutter with a slotted blade
- Durable nylon material in body



Carded



## Sterling® 18-002 Row Cutter

### RED ROW CARPET CUTTER

| CODE          | DESCRIPTION | BOX QTY | CTN QTY |
|---------------|-------------|---------|---------|
| <b>18-002</b> | Red Carded  | 1       | 1       |

Replacement blade code 420-4. *See pg. 211*

- Takes heavy duty 3 hole technical blade
- Ideal for cutting all jute/hessian back carpets
- Reinforcing rib down front of cutter strengthens guiding nose
- Strong durable nylon material for long life



Carded

## Sterling® 18-410 Loop Pile Cutter

### LOOP PILE CUTTER

| CODE          | DESCRIPTION   | BOX QTY | CTN QTY |
|---------------|---------------|---------|---------|
| <b>18-410</b> | Silver Carded | 1       | 36      |

Replacement blade code 40-101. See pg. 212

- Adjustable throat for various carpet thicknesses
- Blade set at ideal cutting angle
- Double blades for close seam cuts
- Easy hand tightening with ring grips on adjusting screws



Carded

## Sterling® 18-040 Seam Roller

### 4" SEAM ROLLER 100MM

| CODE          | DESCRIPTION | BOX QTY | CTN QTY |
|---------------|-------------|---------|---------|
| <b>18-040</b> | Carded      | 12      | 36      |

- Star washer design
- Angled head for ease of use
- Pushes Carpet Backings firmly into adhesive



Carded

## Sterling® 18-030 Star Flex

### 4" FLEX ACTION ROLLER 100MM

| CODE          | DESCRIPTION | BOX QTY | CTN QTY |
|---------------|-------------|---------|---------|
| <b>18-030</b> | Carded      | 6       | 36      |

- Star washers on pivoting axles to draw and blend carpet yarns together at the same time as pushing carpet backing into adhesive



Carded

## Sterling® 18-050 Seam Roller

### 6" SEAM ROLLER 150MM

| CODE          | DESCRIPTION | BOX QTY | CTN QTY |
|---------------|-------------|---------|---------|
| <b>18-050</b> | Carded      | 6       | 48      |

- Star washer design
- Angled head for ease of use
- Wider roller for flatter and stronger seams



Carded



## Sterling® 18-010 Smooth Roller

### 4" SMOOTH SEAM ROLLER 100MM

| CODE   | DESCRIPTION | BOX QTY | CTN QTY |
|--------|-------------|---------|---------|
| 18-010 | Carded      | 6       | 36      |

- Suitable for all carpet types
- Smooth rollers do not mark carpet or get caught in yarns



Carded



## Sterling® 18-020 Smooth Roller

### 6" SMOOTH SEAM ROLLER 150MM

| CODE   | DESCRIPTION | BOX QTY | CTN QTY |
|--------|-------------|---------|---------|
| 18-020 | Carded      | 6       | 48      |

- Suitable for all carpet types
- Smooth rollers do not mark carpet or get caught in yarns

## 18-550 Comfi



### COMFI-STYLE KNEE PADS

| CODE   | DESCRIPTION        | BOX QTY | CTN QTY |
|--------|--------------------|---------|---------|
| 18-550 | Orange/Black Boxed | Pair    | 12      |

- Durable and strong 1680D polyester fabric
- Elastic straps with Velcro fastening for rapid fit
- Non-marking design for smooth surfaces

Boxed







18-530 Gel

Sterling®

**RIBBED CAP GEL KNEE PAD**

| CODE          | DESCRIPTION | BOX QTY | CTN QTY |
|---------------|-------------|---------|---------|
| <b>18-530</b> | Black Boxed | Pair    | 12      |

- Non-marking flexible rubber caps
- Injected gel pad for extra cushioning & impact resistance
- Adjustable elastic straps with Velcro fasteners



Boxed



Sterling®

18-540 Multi Cap

**INTERCHANGEABLE CAP GEL KNEE PADS**

| CODE          | DESCRIPTION | BOX QTY | CTN QTY |
|---------------|-------------|---------|---------|
| <b>18-540</b> | Black Boxed | Pair    | 12      |

- 2 types of interchangeable caps
- Non marking glide caps
- Grooved caps for extra grip
- Thick foam gel protects knees



Boxed



Sterling® 18-501 Rubber Cap

**RUBBER CAP HEAVY DUTY KNEE PAD**

| CODE          | DESCRIPTION      | BOX QTY | CTN QTY |
|---------------|------------------|---------|---------|
| <b>18-501</b> | Black/White Bulk | Pair    | 20      |

- Thick foam padding for impact resistance
- White rubber caps are non-marking and slip resistant
- Double cap design for use with knee-kickers
- Comfortable elastic straps with easy Velcro fasteners



# A smooth change

The **Sterling Slidelock trowel** make easy work of trowelling with their **innovative handle and blade interchange** feature. ***Just knock the old blade out and knock the new one in!*** Comfortable rubber grip centre handle **suits right and left hand users** too!



Replaceable blades

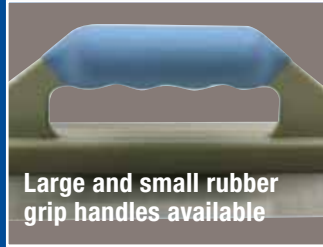

Large and small rubber grip handles available

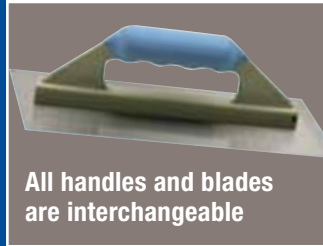

All handles and blades are interchangeable

# Sterling Slide-Lock Handles

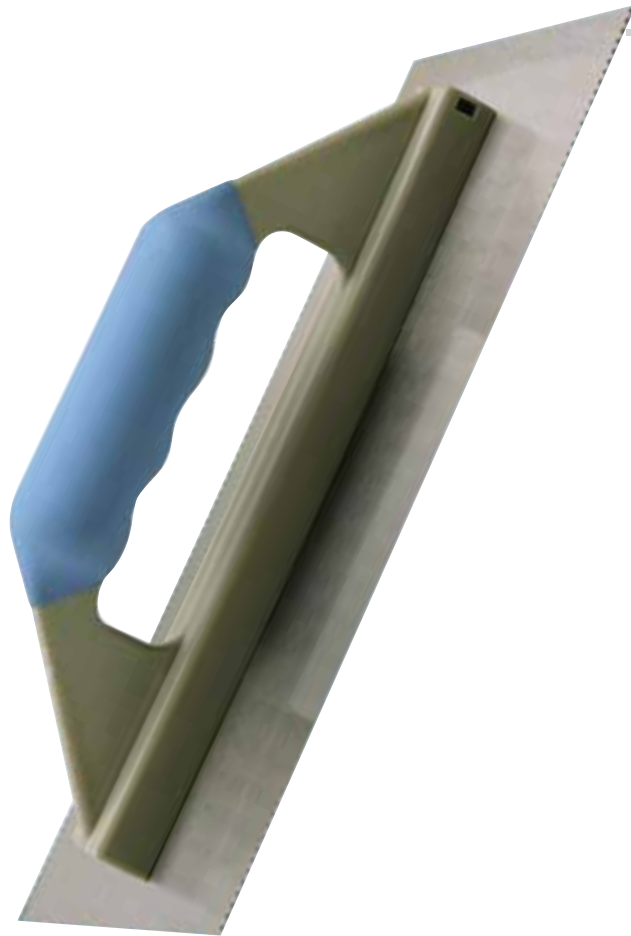

trowels

75

*Sterling*<sup>®</sup>

### SLIDELOCK TROWEL HANDLES

| CODE         | DESCRIPTION | BOX QTY | CTN QTY |
|--------------|-------------|---------|---------|
| <b>17-H1</b> | Small Grip  | 10      | 120     |
| <b>17-H2</b> | Large Grip  | 10      | 120     |



- Replaceable blade and handle trowel system
- Large and small rubber grip handles available
- All handles and blades are interchangeable
- Centre handle position suits right and left hand users
- Centre position allows both sides of the blade to be used without reversing the handle

*Sterling*<sup>®</sup>

SLIDELOCK TROWELS

Sterling

“Knock it in - knock it out”



## BRILLIANT!

Fast and easy blade changes. Handle attaches to the blade by sliding it along a full length spine which provides a strong secure handle attachment to the blade. The SLIDELOCK system allows the same handle to be used with different notch size blades.

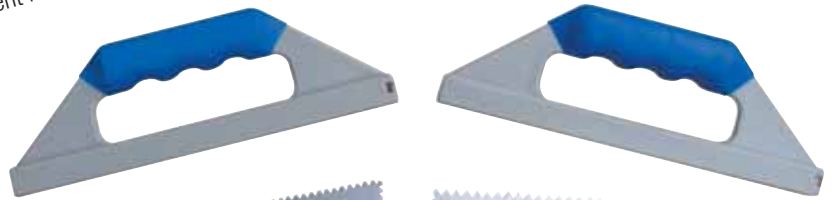

## CHOICE!

SLIDELOCK Trowel System features either a large or small ergonomic soft grip handle fully interchangeable with 8 different blade styles. This provides the most universal trowel selection available for the flooring market.



## DURABLE!

Centrally located handle is easier for left handed users and reduces uneven wear on the blade notching. Both sides of the blade can be used without removing the handle. Simply turn it around. All SLIDELOCK notched blades are the popular parallelogram shape and are manufactured from heavy gauge high quality steel and are double notched for long life.

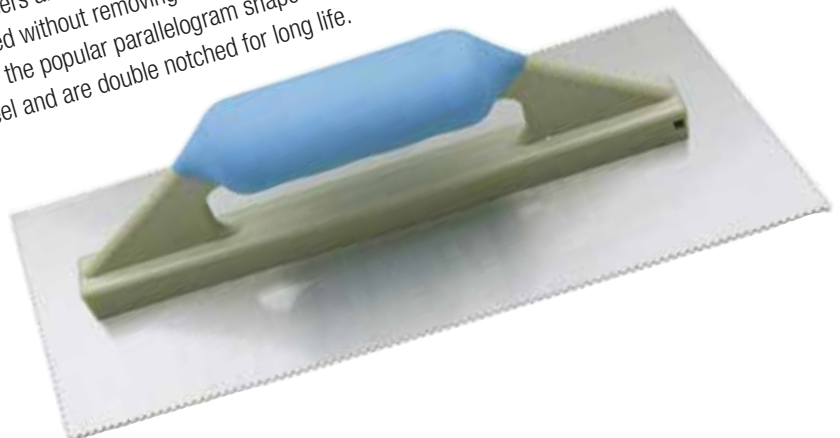

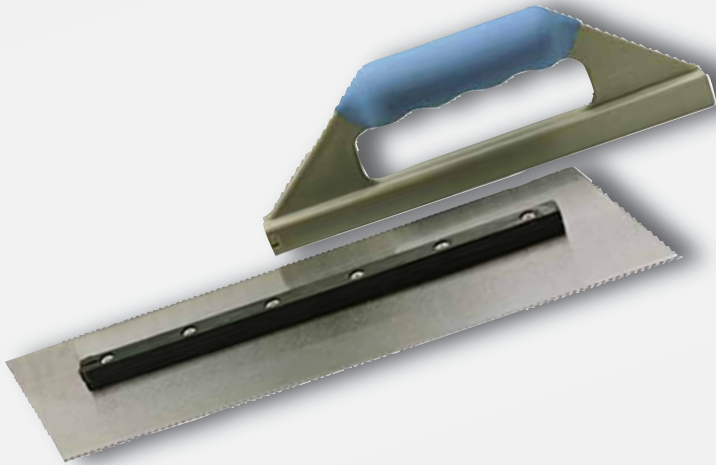

Slidelock  
Trowel  
Blades

## 36-150 Levelling Trowel

### STRAIGHT EDGE LEVELLING TROWEL

| CODE          | DESCRIPTION | BOX QTY | CTN QTY |
|---------------|-------------|---------|---------|
| <b>36-150</b> | Bulk        | 6       | 36      |

- Ergo soft rubber grip handle
- Stainless Steel straight edged blade
- Ideal for floor levelling



| CODE          | DESCRIPTION             | BOX QTY | CTN QTY |
|---------------|-------------------------|---------|---------|
| <b>17-ST</b>  | Straight                | 25      | 100     |
| <b>17-VN1</b> | 1.6mm V Notch           | 25      | 100     |
| <b>17-VN2</b> | 2.4mm V Notch           | 25      | 100     |
| <b>17-VN3</b> | 3.2mm V Notch           | 25      | 100     |
| <b>17-VN5</b> | 4.8mm V Notch           | 25      | 100     |
| <b>17-VN6</b> | 6.0mm Alternate V Notch | 25      | 100     |
| <b>17-U1</b>  | 0.8mm U Notch           | 25      | 100     |
| <b>17-SQ1</b> | 1.6mm Square Notch      | 25      | 100     |

- Different replaceable blades to suit SLIDELock Trowel Handles
- Heavy gauge blades resist wear
- Full spline prevents blade falling off when in use
- Notching on 4 edges of blade allows both sides to be used

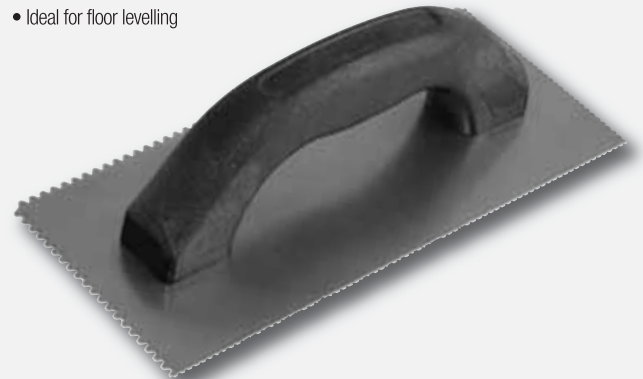

## 17-635 Economy Notched Trowel

### STRAIGHT EDGE LEVELLING TROWEL

| CODE          | DESCRIPTION             | BOX QTY | CTN QTY |
|---------------|-------------------------|---------|---------|
| <b>17-635</b> | 1.6mm & 2.4mm V notches | 10      | 50      |

- Economy trowel with 4 sides notching –  
1.6mm on one side and end, 2.4mm notching the other side and end
- Ideal for small and DIY jobs
- One trowel suits both vinyl and carpet glues
- Sturdy blade and comfortable D handle makes the trowel easy to use

# Heavyweight champ



The **Floordot F1 Premium Knee Kicker** delivers a great punch! It's **unique design** transfers force more efficiently from the knee to the carpet, and **requires 30% less effort** to move carpet. And it's **quality 3" buffer** means **ultimate knee protection** too.

**Sterling**<sup>®</sup>  
**Floor Dot**



## Floor Dot 04-0140

### F1 PREMIUM KNEE KICKER

| CODE    | DESCRIPTION         | BOX QTY | CTN QTY |
|---------|---------------------|---------|---------|
| 04-0140 | Premium Knee Kicker | 1       | 1       |

- Premium streamlined Knee Kicker shifts carpet more efficiently
- Unique design transfers force direct from knee to carpet
- Requires 30% less effort to move carpet
- Quality 3" buffer for ultimate knee protection
- Strong robust construction
- Unique positive length adjustment is fast and secure

## Floor Dot 04-0160

### HIGH ARCH KNEE KICKER

| CODE    | DESCRIPTION           | BOX QTY | CTN QTY |
|---------|-----------------------|---------|---------|
| 04-0160 | High Arch Knee Kicker | 1       | 1       |

- High arch gets over carpet stretcher poles
- Quality 2" buffer for knee protection
- Wide head design
- Strong twin locking length adjustment prevents pin elongation

floorrobot

## Knee Kicker Replacement Parts



### F1 PIN PLATE

| CODE     | DESCRIPTION  | BOX QTY | CTN QTY |
|----------|--------------|---------|---------|
| 4-0140-1 | F1 Pin Plate | 1       | -       |

- Suits F1 Knee Kicker



### PIN PLATE

| CODE      | DESCRIPTION | BOX QTY | CTN QTY |
|-----------|-------------|---------|---------|
| 04-0150-1 | Pin Plate   | 1       | -       |

- Suits High Arc Knee Kicker



### BUMPER PAD

| CODE      | DESCRIPTION        | BOX QTY | CTN QTY |
|-----------|--------------------|---------|---------|
| 04-0140-5 | Bumper Pad 75mm/3" | 1       | -       |

- Suits all Floor Dot Knee Kickers



### BUMPER PAD

| CODE      | DESCRIPTION         | BOX QTY | CTN QTY |
|-----------|---------------------|---------|---------|
| 04-0140-4 | Bumper Pads 50mm/2" | 1       | -       |

- Suits all Floor Dot Knee Kickers



### NAP GRIP PADS

| CODE      | DESCRIPTION                  | BOX QTY | CTN QTY |
|-----------|------------------------------|---------|---------|
| 04-0150-2 | Nap Grip Pads (Cotton heads) | 1       | -       |

- Set of 3
- Suits all knee kickers



### PIN COVER

| CODE    | DESCRIPTION               | BOX QTY | CTN QTY |
|---------|---------------------------|---------|---------|
| 04-0161 | Pin Cover for Knee Kicker | 1       | -       |

- Suits High Arc Knee Kicker



## 8" Extendable Floor Scraper



### Floor Dot

#### 200MM (8") EXTENDABLE FLOOR SCRAPER

| CODE           | DESCRIPTION           | BOX QTY | CTN QTY |
|----------------|-----------------------|---------|---------|
| <b>03-0016</b> | 8" Extendable Scraper | 1       | -       |

- Solid blade holding and clamping
- Blade will not slip in use
- Extendable handle with twist lock action allows stand up scraping
- Comfortable handle grips

Replacement blade 04-3032. See pg. 197

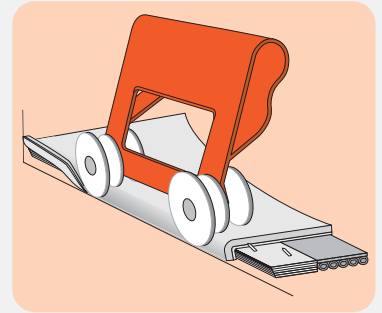

## Tucker Roller



### Floor Dot

#### TUCKER ROLLER

| CODE           | DESCRIPTION             | BOX QTY | CTN QTY |
|----------------|-------------------------|---------|---------|
| <b>04-0290</b> | Tucker Roller           | 1       | 1       |
| <b>04-0291</b> | Replacement Wheels (x2) | 1       | 1       |

- Tucks down carpet and pushes carpet into gripper pins
- Unique design applies force where it is needed
- Great time saver



Carded



Wall Trimmer

## Floor Dot

### WALL TRIMMER

| CODE     | DESCRIPTION                   | BOX QTY | CTN QTY |
|----------|-------------------------------|---------|---------|
| 04-0510  | Wall Trimmer                  | 1       | 1       |
| 18-070WR | Replacement nylon wall runner | 1       | 1       |

- Adjustable wall trimmer for different carpet thicknesses
- Durable construction with all metal parts
- Replaceable nylon wall runner

Replacement blade 941. See pg. 178.



## Floor Dot Seam Roller

### 4" SEAM ROLLER

| CODE    | DESCRIPTION            | BOX QTY | CTN QTY |
|---------|------------------------|---------|---------|
| 04-0270 | 4" (100mm) Seam Roller | 1       | 1       |

- Star washer design
- Angled head for ease of use



## Floor Dot Loop Pile Cutter

### LOOP PILE CUTTER

| CODE    | DESCRIPTION      | BOX QTY | CTN QTY |
|---------|------------------|---------|---------|
| 04-0505 | Loop Pile Cutter | 1       | 1       |

- Adjustable throat for various carpet thickness
- Double blades for close seam cuts
- Heavy gauge sturdy construction will not twist or wander in use

Takes 40-101 or 04-3017 blades. See pg. 212.





## Floor Dot Cushion Back Cutter

### CUSHION BACK CUTTER

| CODE    | DESCRIPTION         | BOX QTY | CTN QTY |
|---------|---------------------|---------|---------|
| 04-0500 | Cushion Back Cutter | 1       | 1       |

- Features double blades for close seam cuts
- Easy ring grip adjustable screws
- Heavy gauge sturdy construction

Takes 40-101 or 04-3017 blades. See pg. 212.



## Floor Dot Napping Shears

### 200MM (8") OFFSET NAPPING SHEARS

| CODE    | DESCRIPTION                      | BOX QTY | CTN QTY |
|---------|----------------------------------|---------|---------|
| 04-0608 | 200mm (8") Offset Napping Shears | 1       | 1       |

- Offset handle for level cutting
- Vinyl coated handles for ease of grip
- Highest quality- Made in Europe



## Floor Dot Row Cutter

### RED ROW CUTTER

| CODE    | DESCRIPTION    | BOX QTY | CTN QTY |
|---------|----------------|---------|---------|
| 04-0499 | Red Row Cutter | 1       | 1       |

- Popular design row cutter
- Durable plastic material for long life
- Rigid nose to prevent wandering

Takes 420-4 blades. See pg. 211.



## Floor Dot 10" Carpet Shears

### 250MM (10") CARPET SHEARS

| CODE    | DESCRIPTION               | BOX QTY | CTN QTY |
|---------|---------------------------|---------|---------|
| 04-0612 | 250mm (10") Carpet Shears | 1       | 1       |

- Drop forged cutlery steel blades provide the highest quality and durability
- Resharpenable blades with adjustable tension
- Made in Europe

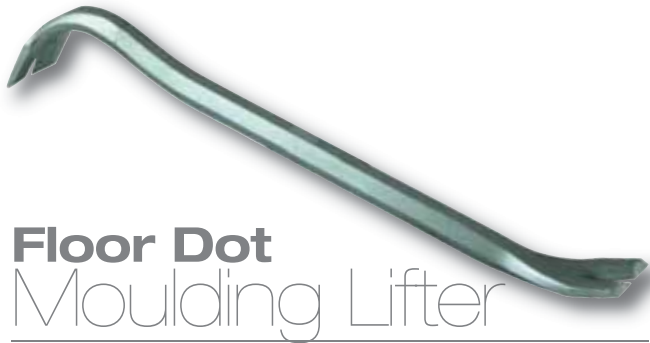

## Floor Dot Moulding Lifter

### BASE MOULDING LIFTER

| CODE    | DESCRIPTION          | BOX QTY | CTN QTY |
|---------|----------------------|---------|---------|
| 04-0680 | Base Moulding Lifter | 1       | 1       |

- Forged and hardened for maximum durability
- Pulls nails with both ends



## Techni-edge Heavy Duty Art Knife

### HEAVY DUTY ART KNIFE

| CODE  | DESCRIPTION                | BOX QTY | CTN QTY |
|-------|----------------------------|---------|---------|
| 50005 | No. 5 Heavy Duty Art Knife | 12      | -       |

- Large PLastic Grip for better hold when grooving
- Heavy Duty art knife supplied with No.24 craft blade
- Used with 05-0091 blades for Vinyl grooving



## Floor Dot P Groover

### P GROOVER

| CODE    | DESCRIPTION        | BOX QTY | CTN QTY |
|---------|--------------------|---------|---------|
| 05-0010 | PVC & Lino Groover | 1       | 1       |

- Strong cast alloy handle for rigidity
- Rubberized grip - prevents slipping
- Replaceable blade has rigid 2 pin connection

Carded



## Nail Driving Bar



## Floor Dot

### NAIL DRIVING BAR

| CODE    | DESCRIPTION      | BOX QTY | CTN QTY |
|---------|------------------|---------|---------|
| 04-0670 | Nail Driving Bar | 1       | 1       |

- Strong magnetic tip holds nails for driving into awkward and hard to reach places
- PVC Rubber coated handle prevents shocks to hand from hammer blows
- Largest magnet in industry to ensure positive grip on nail head

# Grooving Blades - Highest Quality "Exacto™" Blades



## Floor Dot P Groover Blade

### REPLACEMENT BLADE FOR P GROOVER

| CODE    | DESCRIPTION                     | BOX QTY | CTN QTY |
|---------|---------------------------------|---------|---------|
| 05-0011 | Replacement Blade for P Groover | 1       | 1       |

- Spring steel blade for durability
- Pack of 5



## Floor Dot Multi Scriber

### MULTI SCRIBER

| CODE    | DESCRIPTION   | BOX QTY | CTN QTY |
|---------|---------------|---------|---------|
| 05-0080 | Multi Scriber | 1       | 1       |

- Spring steel blade for durability
- Ideal for transcribing edge of lower sheet to upper sheet for perfect seams



## 05-0091-3

### SMALL ROUND BLADE - PACK OF 2

| CODE      | DESCRIPTION       | BOX QTY | CTN QTY |
|-----------|-------------------|---------|---------|
| 05-0091-3 | Small Round Blade | 1       | 1       |

- Suits 50005 Heavy Duty Art Knife



## 05-0091-2

### LARGE ROUND BLADE - PACK OF 2

| CODE      | DESCRIPTION       | BOX QTY | CTN QTY |
|-----------|-------------------|---------|---------|
| 05-0091-2 | Large Round Blade | 1       | 1       |

- Suits 50005 Heavy Duty Art Knife



## 05-0091-1

### DIAMOND BLADE - PACK OF 2

| CODE      | DESCRIPTION   | BOX QTY | CTN QTY |
|-----------|---------------|---------|---------|
| 05-0091-1 | Diamond Blade | 1       | 1       |

- Suits 50005 Heavy Duty Art Knife



## 05-0091-4

### FLAT BLADE - PACK OF 2

| CODE      | DESCRIPTION | BOX QTY | CTN QTY |
|-----------|-------------|---------|---------|
| 05-0091-4 | Flat Blade  | 1       | 1       |

- Suits 50005 Heavy Duty Art Knife





# Scrapers

*Everyone* loves the Allway 80-200 Brass Button Scraper! The **most popular universal scraper**, it's demanded by professionals, and it's **safer to use** as the blade cannot slide out during use.



High quality - Made in USA



Safer as blade will not slide out during use



Most popular model

80-200 Brass Button



Carded GS-1

Allway

BRASS BUTTON SCRAPER

| CODE    | DESCRIPTION                 | BOX QTY | CTN QTY |
|---------|-----------------------------|---------|---------|
| 80-200* | Silver Bulk                 | 50      | 300     |
| GS-1    | Silver Carded with 5 blades | 10      | 200     |

\*Supplied without blade

- High quality Made in USA
- The most popular universal scraper
- Blade cannot slide out during use which makes this scraper safer to use
- Demanded by Professionals

Replacement blade 30-112. See pg. 193.



Bucket of 50



Sterling®

SGS25 - Soft Grip



## Allway

### SOFT GRIP BRASS BUTTON SCRAPER

| CODE         | DESCRIPTION | BOX QTY | CTN QTY |
|--------------|-------------|---------|---------|
| <b>SGS25</b> | Grey Bulk   | 25      | 150     |

Replacement Blade single edge razor blade. *See pg. 193*

- Soft rubber grip casing for superior grip
- Ideal for cleaners and car detailers
- High quality Made in USA
- Blade cannot slide out during use which makes this scraper safer to use
- Counter bucket of 25pcs



Bucket of 25



## Sterling® 80-202 Metal Scraper

### HEAVY DUTY METAL SCRAPER

| CODE           | DESCRIPTION            | BOX QTY | CTN QTY |
|----------------|------------------------|---------|---------|
| <b>80-202</b>  | Silver Bulk w/o blade  | 100     | 100     |
| <b>80-202B</b> | Silver Bulk with blade | 100     | 100     |

Replacement Blade single edge razor blade. *See pg. 193*

- Heavy duty scraper
- Made in USA
- Contoured handle for superior control



## Sterling® 208 Plastic

### RETRACTABLE PLASTIC SCRAPER

| CODE         | DESCRIPTION   | BOX QTY | CTN QTY |
|--------------|---------------|---------|---------|
| <b>208</b>   | Yellow Bulk   | 60      | 600     |
| <b>208B</b>  | Blue Bulk     | 60      | 600     |
| <b>TH208</b> | Yellow Carded | 60      | 600     |

Replacement Blade single edge razor blade. *See pg. 193*

- Scraper supplied with 1 blade
- Available in Yellow or Blue



Carded



14-708 Longreach



Sterling®

**LONGREACH LONG HANDLED SCRAPER SCRAPER**

| CODE          | DESCRIPTION         | BOX QTY | CTN QTY |
|---------------|---------------------|---------|---------|
| <b>14-708</b> | Hangable with blade | 24      | 144     |

Replacement Blade single edge razor blade. *See pg. 193*

- Comfortable rubbergrip handle
- 200mm (8") long metal handle for hard to reach areas
- Blade held tightly with screw clamp
- Takes single edge blades

Hangable



80-214 Mini

**PLASTIC MINI SCRAPER**

| CODE          | DESCRIPTION | BOX QTY | CTN QTY |
|---------------|-------------|---------|---------|
| <b>80-214</b> | Yellow Bulk | 20      | 1200    |

Replacement Blade single edge razor blade. *See pg. 193*

- Scraper supplied with 1 blade
- Blade can be reversed for storage



PSEB-5 Mini Plastic

**MINI SCRAPER WITH PLASTIC RAZOR BLADES**

| Code          | Description                    | Box Qty | Ctn Qty |
|---------------|--------------------------------|---------|---------|
| <b>PSEB-5</b> | Scraper with 5 blades - Carded | 1       | 1       |

Replacement blades – plastic razor blades. Code SEB25: *See pg. 194*

- Scraper supplied with 5 plastic double edge blades
- Plastic Blades eliminate scratches
- Ideal for Windows & Pinstripping

Carded





## Sterling 1915 Ergoscraper

### ERGOSCRAPER PROFESSIONAL WINDOW SCRAPER 150MM (6")

| CODE        | DESCRIPTION      | BOX QTY | CTN QTY |
|-------------|------------------|---------|---------|
| <b>1915</b> | Black/Red Carded | 6       | 60      |

Replacement Blade 821502 or 854-020. *See pg. 199*

- Wide 150mm (6") Scraper covers area faster
- Soft grip handle
- Supplied with replaceable cap
- Robust construction for professional window cleaners
- Easily attaches to Extension Poles



Carded



## 1917 Triumph Mk2

### TRIUMPH MK2 150MM (6") SCRAPER

| CODE        | DESCRIPTION  | BOX QTY | CTN QTY |
|-------------|--------------|---------|---------|
| <b>1917</b> | Black Carded | 5       | 250     |

Replacement Blade 821502 or 854020. *See pg. 199*

- Supplied with replaceable cap and squeegee
- Robust ABS construction
- Easily attaches to Extension Poles



## 1916 Triumph Mk3

### TRIUMPH ANGLED MK3 150MM (6") SCRAPER

| CODE        | DESCRIPTION      | BOX QTY | CTN QTY |
|-------------|------------------|---------|---------|
| <b>1916</b> | Black/Red Carded | 1       | 1       |

Replacement Blade 821502 or 854-020. *See pg. 199*

- Angled scraping head
- Rubber Grip Handle
- Ideal for use on extension pole



## 1918 Champion Scraper

### CHAMPION 125MM (5") SCRAPER

| CODE        | DESCRIPTION  | BOX QTY | CTN QTY |
|-------------|--------------|---------|---------|
| <b>1918</b> | Black Carded | 1       | 1       |

Replacement Blade 821252. *See pg. 199*

- Comes with replaceable safety cap
- Easily attaches to Extension Poles



## WPSOCR Wagtail

### WAGTAIL 4" WINDOW SCRAPER

| CODE          | DESCRIPTION  | BOX QTY | CTN QTY |
|---------------|--------------|---------|---------|
| <b>WPSOCR</b> | White Carded | 1       | 1       |

Replacement Blade 820943 or 894-030. *See pg. 198*

- Integrated washer wets glass as scraper is being used to prevent scratching
- Adjustable pivoting head to get the optimum angle to the window & frames
- Handle easily attaches to extension poles
- Blade & washer pad are easily replaceable



## Sterling HDSCR Window Scraper

### PLASTIC WINDOW SCRAPER 94MM (4")

| CODE         | DESCRIPTION       | BOX QTY | CTN QTY |
|--------------|-------------------|---------|---------|
| <b>HDSCR</b> | Black - Carded    | 12      | 144     |
| <b>BLC</b>   | Blade Cover       | 1       |         |
| <b>BHL</b>   | Blade Holders Set | 1       |         |

- Replacement Blade 820943 or 894030. *See pg. 198*
- Most popular window scraper
- Comes with replaceable plastic cap
- Replacement caps (BLC) and blade holder (BHL) available
- Easily attaches to Extension Poles

Carded



## Sterling 1910 Window Scraper

### 100MM (4") WINDOW SCRAPER

| CODE        | DESCRIPTION | BOX QTY | CTN QTY |
|-------------|-------------|---------|---------|
| <b>1910</b> | Grey Carded | 12      | 240     |

Replacement Blade 6234. *See pg. 196*

- Quick Press button blade change
- Store with blunt edge out
- Scrape with sharp edge out



Carded



## 1919 Handy

### HANDY SCRAPER 80MM

| CODE        | DESCRIPTION | BOX QTY | CTN QTY |
|-------------|-------------|---------|---------|
| <b>1919</b> | Blue Carded | 10      | 140     |

Replacement Blade 820802. *See pg. 198*

- Comes with replaceable safety cap



## Sterling® TH48A Red Plastic

### RED PLASTIC SCRAPER

| CODE         | DESCRIPTION | BOX QTY | CTN QTY |
|--------------|-------------|---------|---------|
| <b>TH48A</b> | Red Carded  | 10      | 240     |

Replacement Blade 921, 922 or 924. See pgs. 175-177

- Supplied with safety cap
- Takes Heavy Duty Trimming blade

Carded



## Sterling® Timber Handle Paint Scraper

| CODE           | DESCRIPTION                  | BOX QTY | CTN QTY |
|----------------|------------------------------|---------|---------|
| <b>7263-C1</b> | 25mm (1") Timber - Hang Tab  | 12      | 120     |
| <b>7263-C2</b> | 50mm (2") Timber - Hang Tab  | 12      | 120     |
| <b>7263-C3</b> | 75mm (3") Timber - Hang Tab  | 12      | 120     |
| <b>7263-C4</b> | 100mm (4") Timber - Hang Tab | 12      | 120     |

- Through Tang
- Hi-Carbon Steel blade

## Rhino-Grip



Hang Tab

### Sterling®

#### STERLING RHINO-GRIP STAINLESS STEEL SCRAPERS

| CODE           | DESCRIPTION                  | BOX QTY | CTN QTY |
|----------------|------------------------------|---------|---------|
| <b>7363-S1</b> | 1"(25mm) Rhino-Grip Scraper  | 12      | 48      |
| <b>7363-S2</b> | 2"(50mm) Rhino-Grip Scraper  | 12      | 48      |
| <b>7363-S3</b> | 3"(75mm) Rhino-Grip Scraper  | 12      | 48      |
| <b>7363-S4</b> | 4"(100mm) Rhino-Grip Scraper | 12      | 48      |

- Rubberized RHINOGRIP handle provides comfortable, secure grip even in wet areas
- Quality Polished Stainless Steel scraper blade has ideal flexibility and durability
- Suitable for industrial and Food applications
- Available in a range of sizes from 1" (25mm) – 4" (100mm)



## Plastic Handle Paint Scraper

### PLASTIC HANDLE PAINT SCRAPER

| CODE             | DESCRIPTION                         | BOX QTY | CTN QTY |
|------------------|-------------------------------------|---------|---------|
| <b>7163-S1</b>   | 25mm (1") S/S Plastic Black Bulk    | 12      | 120     |
| <b>7163-S1.5</b> | 38mm (1.5") S/S Plastic Black Bulk  | 12      | 120     |
| <b>7163-S2</b>   | 50mm (2") S/S Plastic Black Bulk    | 12      | 120     |
| <b>7163-S3</b>   | 75mm (3") S/S Plastic Black Bulk    | 12      | 120     |
| <b>7163-S4</b>   | 100mm (4") S/S Plastic Black Bulk   | 12      | 120     |
| <b>7163-C2**</b> | 50mm (2") Carbon Plastic Black Bulk | 12      | 120     |

- Through Tang
- Stainless Steel blade or Carbon Steel blade\*\*
- Stainless Steel suitable for food industry



Hang Tab



## Paint-Scrape

### PAINT-SCRAPE 4" (100MM) FLOOR & WALL SCRAPER

| CODE          | DESCRIPTION | BOX QTY | CTN QTY |
|---------------|-------------|---------|---------|
| <b>TH6230</b> | Grey Carded | 10      | 50      |

Replacement Blade 50-151 or 6231. See pg. 196

- 300mm (12") handle
- 3 screws hold the blade securely
- Ideal for paint, wallpaper and light floor preparation

## Tough-Scrape



### TOUGH-SCRAPE 4" (100MM) FLOORING SCRAPER

| CODE          | DESCRIPTION            | BOX QTY | CTN QTY |
|---------------|------------------------|---------|---------|
| <b>14-010</b> | 12" Handle Bulk        | 10      | 60      |
| <b>14-012</b> | 12" Hammer Handle Bulk | 10      | 60      |
| <b>14-030</b> | 18" Handle Bulk        | 10      | 60      |
| <b>14-048</b> | 48" Handle Bulk        | 6       | 24      |

Replacement Blade 50-151-4, 50-153-2, 811004 or 6234. See pg. 196

- Heavy duty wall and floor scraper
- 3 screws holds blade tightly and prevents slipping
- Comfortable cushion grip handle
- 12" available with hammer end for difficult flooring take-ups
- Available with 3 different handle lengths 300mm (12"), 450mm (18"), 1200mm (48")



**Sterling**  
14-088 Power Scrape

**185MM (5") POWER FLOOR SCRAPER**

| CODE          | DESCRIPTION | BOX QTY | CTN QTY |
|---------------|-------------|---------|---------|
| <b>14-088</b> | Silver Bulk | 6       | 24      |

Replacement Blade 50-089-4. See pg. 197

- 430mm (18") handle
- Power weighted ball grip for extra grunt
- 3 screws in head to hold blade securely
- Ideal for toughest applications



**Sterling**  
14-086 Telescopic

**200MM (8") TELESCOPIC FLOOR SCRAPER**

| CODE          | DESCRIPTION | BOX QTY | CTN QTY |
|---------------|-------------|---------|---------|
| <b>14-086</b> | Silver Bulk | 2       | 6       |

Replacement Blade 40-201-4. See pg. 197

- Handle extends from 950mm (38") to 1600mm (63") with twist lock
- 4 screws in head securely hold blade in position
- Stand up scraper - ideal for floor preparation



**Sterling** 14-084  
Floor & Wall

**150MM (6") FLOOR & WALL SCRAPER**

| CODE          | DESCRIPTION | BOX QTY | CTN QTY |
|---------------|-------------|---------|---------|
| <b>14-084</b> | Black Bulk  | 12      | 48      |

Replacement Blade 50-085-4. See pg. 197

- 600mm (24") handle
- 2 screws in head to hold blade
- Ideal for stripping wallpaper etc.



FS-8 Warrior

**FLOOR SCRAPER 200MM (8") HEAVY DUTY**

| CODE          | DESCRIPTION       | BOX QTY | CTN QTY |
|---------------|-------------------|---------|---------|
| <b>FS-8</b>   | Bulk              | 1       | 20      |
| <b>FS-8BL</b> | Replacement Blade | 1       | 1       |

- 1200mm (48") fixed length handle
- Stand up scraper for cleaning & floor preparation

F1 Handy



**Allway**

**28MM HANDY SCRAPER**

| CODE      | DESCRIPTION | BOX QTY | CTN QTY |
|-----------|-------------|---------|---------|
| <b>F1</b> | Carded      | 10      | 100     |

Replacement Blade 1B. See pg. 98

- Compact and popular size for small jobs and difficult areas
- 2 edge 28mm (1-1/8") blade
- Ideal for timber, paint and other scraping jobs



Carded

F4 Super



**Allway**

**65MM SUPER SCRAPER**

| CODE      | DESCRIPTION | BOX QTY | CTN QTY |
|-----------|-------------|---------|---------|
| <b>F4</b> | Carded      | 10      | 50      |

Replacement Blade 42B. See pg. 98

- Rugged 2 handed scraper
- Rubber grip handle for comfort
- Comes with 4 edge 65mm (2-1/2") blade



Carded

Includes 6 blades:



Blades available individually

Contour



Carded



## Allway

### SOFT-GRIP CONTOUR ALLWAY SCRAPER

| CODE         | DESCRIPTION          | BOX QTY | CTN QTY |
|--------------|----------------------|---------|---------|
| <b>CS6</b>   | Carded Complete Set  | 1       | 6       |
| <b>CS-B1</b> | Contour Blade Carded | 10      | 10      |
| <b>CS-B2</b> | Contour Blade Carded | 10      | 10      |
| <b>CS-B3</b> | Contour Blade Carded | 10      | 10      |
| <b>CS-B4</b> | Contour Blade Carded | 10      | 10      |
| <b>CS-B5</b> | Contour Blade Carded | 10      | 10      |
| <b>CS-B6</b> | Contour Blade Carded | 10      | 10      |

- Complete set with 6 shaped blades
- Stainless Steel Blades packed in convenient Plastic Wallet
- Bonus file in handle of scraper
- Replacement blades available



## Allway FE1 Soft-Grip

### 28MM SOFT-GRIP SCRAPER

| CODE       | DESCRIPTION | BOX QTY | CTN QTY |
|------------|-------------|---------|---------|
| <b>FE1</b> | Carded      | 5       | 50      |

Replacement Blade 1B. See pg. 98

- Comfortable rubber grip handle
- Compact size with 2 edge 28mm (1-1/8") blade
- Longer handle for ease of use

Carded



## Allway FE2 Soft-Grip

### 38MM SOFT-GRIP SCRAPER

| CODE       | DESCRIPTION | BOX QTY | CTN QTY |
|------------|-------------|---------|---------|
| <b>FE2</b> | Carded      | 5       | 50      |

Replacement Blade 22B. See pg. 98

- Comfortable rubber grip handle
- 4 edge 38mm (1-1/2") blade
- Longer handle for ease of use

Carded





FE4 Soft-Grip



**Carded**

With bonus blade file



FEB7 Soft-Grip  
Merchandiser

**Allway**

**65MM SOFT-GRIP SCRAPER**

| CODE       | DESCRIPTION | BOX QTY | CTN QTY |
|------------|-------------|---------|---------|
| <b>FE4</b> | Carded      | 5       | 50      |

Replacement Blade 42B. See pg. 98

- Comfortable rubber grip handle
- Strong 2 handed scraper for tough jobs
- Comes with bonus blade file in handle
- Supplied with 4 edge 65mm (2-1/2") blade

**Allway**

**SOFT-GRIP SCRAPER WALL MERCHANDISER DISPLAY**

| CODE        | DESCRIPTION  | BOX QTY | CTN QTY |
|-------------|--------------|---------|---------|
| <b>FEB7</b> | Merchandiser | 1       | 1       |

- Contains 5 ea: FE4, FE2, FE1 scrapers & BF1 (Blade File)
- Contains 10 each: 1B Blade, 22B Blade, 42B Blade
- Hangs on peg board style displays

1B 28mm



## Allway

### 28MM SCRAPER BLADE

| CODE      | DESCRIPTION       | BOX QTY | CTN QTY |
|-----------|-------------------|---------|---------|
| <b>1B</b> | Carded - 2 Blades | 10      | 100     |

- 2 edge 28mm (1-1/8") replacement blades
- 2 blades per pack
- Suits F1, *See pg. 95*, FE1 Scrapers, *See pg. 96*.
- Made in USA

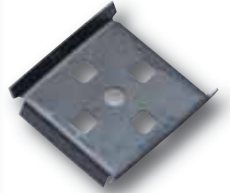
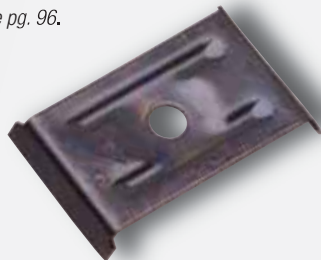

## Allway 22B 30mm

### 22B ALLWAY

| CODE       | DESCRIPTION       | BOX QTY | CTN QTY |
|------------|-------------------|---------|---------|
| <b>22B</b> | Carded - 2 Blades | 10      | 100     |

- 4 edge 38mm (1-1/2") replacement blades
- 2 blades per pack
- Suits FE2 Scraper. *See pg. 96*.
- Made in USA

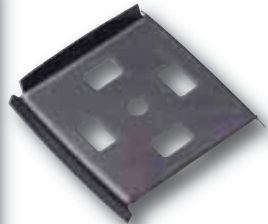

## Allway 42B 65mm

### 65MM SCRAPER BLADE

| CODE       | DESCRIPTION       | BOX QTY | CTN QTY |
|------------|-------------------|---------|---------|
| <b>42B</b> | Carded - 2 Blades | 10      | 100     |

- 4 edge 65mm (2-1/2") replacement blades
- 2 blades per pack
- Suits F4, *See pg. 95*, FE4 Scrapers, *See pg. 97*.
- Made in USA

## SB411 Wire Brush



## Allway

## WIRE BRUSH WITH SCRAPER

| CODE         | DESCRIPTION | BOX QTY | CTN QTY |
|--------------|-------------|---------|---------|
| <b>SB411</b> | Carded      | 6       | 36      |

- Heavy duty brush with structural foam handle
- 300mm (12") overall length
- Solvent proof body with scraper end
- Made in USA

## BF1 Blade File



## Allway

## BLADE FILE

| CODE       | DESCRIPTION      | BOX QTY | CTN QTY |
|------------|------------------|---------|---------|
| <b>BF1</b> | Carded           | 10      | 50      |
| <b>BF2</b> | Mini File Carded | 10      | 50      |

- Made especially to sharpen blades to a fine, sharp, smooth edge
- BF2 Mini file is replacement file for FE4 Scrapers. *See pg. 97.*



## Allway CBS10 1" Carbide

### 1" TRIANGULAR CARBIDE SCRAPER

| CODE         | DESCRIPTION | BOX QTY | CTN QTY |
|--------------|-------------|---------|---------|
| <b>CBS10</b> | Carded      | 5       | 50      |

Replacement Blade CB10.

- Tungsten Carbide 25mm (1") triangle shaped 3 edge blade
- Comfortable softgrip handle
- Blade can be used flat or pointed

Carded



## Allway CBS25 2 1/2" Carbide

### 2-1/2" CARBIDE ALLWAY SCRAPER

| CODE         | DESCRIPTION | BOX QTY | CTN QTY |
|--------------|-------------|---------|---------|
| <b>CBS25</b> | Carded      | 5       | 50      |

Replacement Blade CB25.

- 2 edge 65mm (2-1/2") tungsten carbide replaceable blade
- Comfortable softgrip handle
- Soft grip knob for superior control
- Ideal head angle for paint & timber scraping

Carded



## Allway CBS20 2" Carbide

### 2" CARBIDE SCRAPER

| CODE         | DESCRIPTION | BOX QTY | CTN QTY |
|--------------|-------------|---------|---------|
| <b>CBS20</b> | Carded      | 5       | 50      |

Replacement Blade CB20.

- 2 edge 50mm (2") tungsten carbide replaceable blade
- Comfortable softgrip handle
- Head design gives optimum scraping angle

Carded



## Allway CB10 1" Carbide

### CB10 ALLWAY CARBIDE BLADE

| CODE        | DESCRIPTION      | BOX QTY | CTN QTY |
|-------------|------------------|---------|---------|
| <b>CB10</b> | Carded - 1 blade | 5       | 50      |

- 25mm (1") triangle shaped blade
- Diamond honed tungsten carbide replacement blade
- 3 scraping edges
- Suits CBS10 Scraper





## Allway CB20 2" Carbide

### 2" CARBIDE BLADE

| CODE        | DESCRIPTION      | BOX QTY | CTN QTY |
|-------------|------------------|---------|---------|
| <b>CB20</b> | Carded - 1 blade | 5       | 50      |

- 50mm (2") diamond honed tungsten carbide replacement blade
- 2 scraping edges
- Suits CBS20 Scraper

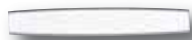

## Allway CB25 2 1/2" Carbide

### 2 1/2" CARBIDE BLADE

| CODE        | DESCRIPTION      | BOX QTY | CTN QTY |
|-------------|------------------|---------|---------|
| <b>CB25</b> | Carded - 1 blade | 5       | 50      |

- 65mm (2½") diamond honed tungsten carbide replacement blade
- 2 scraping edges
- Suits CBS25 Scraper



## CBSM6 Carbide Merchandiser

### Allway

#### CARBIDE SCRAPER WALL MERCHANDISER

| CODE         | DESCRIPTION  | BOX QTY | CTN QTY |
|--------------|--------------|---------|---------|
| <b>CBSM6</b> | Merchandiser | 1       | 1       |

- Supplied with 5 each of CBS10, CBS20, CBS25 scrapers, and CB10, CB20, CB25 blades
- Hangs on pegboard style displays

Always ready to cut down on carpet gripper, small PVC and timber mouldings, the **Sterling 1105 Universal Shears** are made for **durability with extra tough construction.**

Shear strength

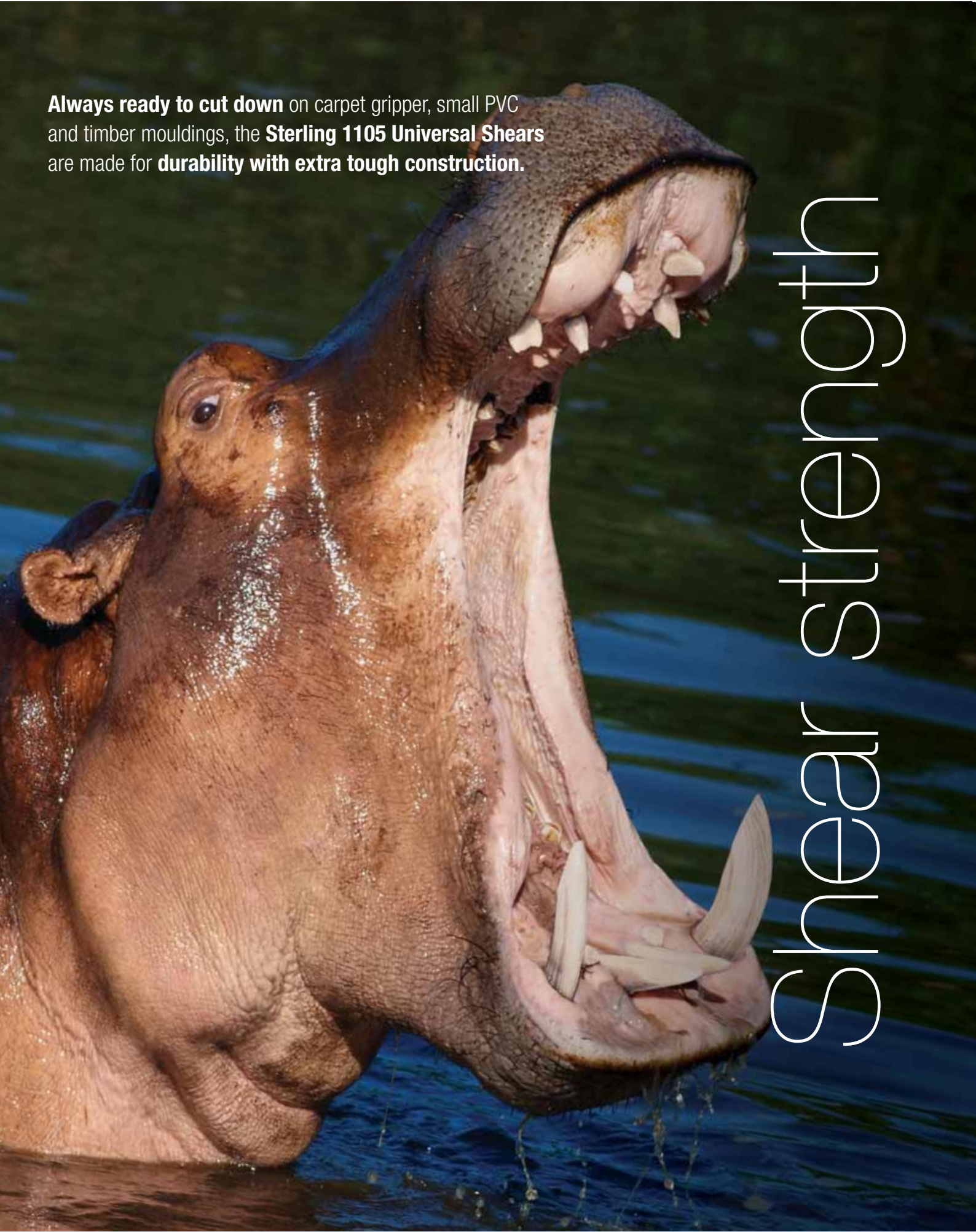

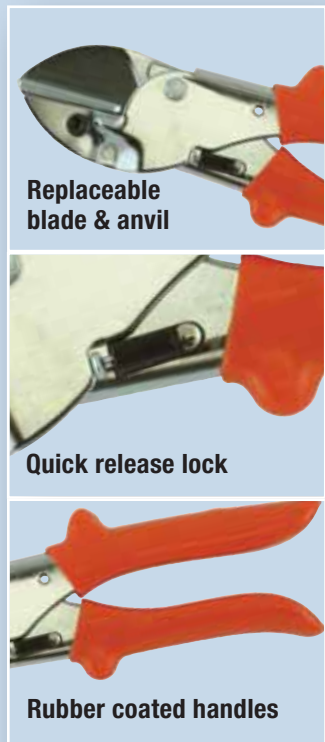

Replaceable blade & anvil

Quick release lock

Rubber coated handles



1105 Universal

**Sterling**

**UNIVERSAL HEAVY DUTY SHEARS**

| CODE         | DESCRIPTION            | BOX QTY | CTN QTY |
|--------------|------------------------|---------|---------|
| <b>1105</b>  | Shears Carded          | 6       | 36      |
| <b>1105B</b> | Replacement Blade Bulk | 1       | 1       |
| <b>1105A</b> | Replacement Anvil Bulk | 1       | 1       |

- For cutting carpet gripper and small PVC and timber mouldings
- Replaceable blade and anvil
- Extra tough construction for durability
- Max cutting length - 35mm
- Jaw height - 35mm



Carded

shears 103

**Sterling**

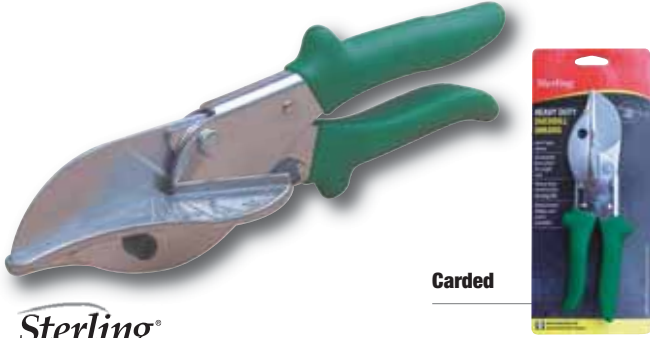

Carded

## Sterling® 3104N Duck Bill

### DUCK BILL HEAVY DUTY MITRE SHEARS

| CODE         | DESCRIPTION            | BOX QTY | CTN QTY |
|--------------|------------------------|---------|---------|
| <b>3104N</b> | Shears Carded          | 6       | 36      |
| <b>3104B</b> | Replacement Blade Bulk | 1       | 1       |
| <b>3104A</b> | Replacement Anvil Bulk | 1       | 1       |

- Max cutting length - 50mm
- Jaw height - 40mm Graduated base plate for accurate angle cuts
- Heavy duty construction for durability
- Ideal for cutting PVC, concreting fillet, and small timber moldings
- Replaceable blade and anvil

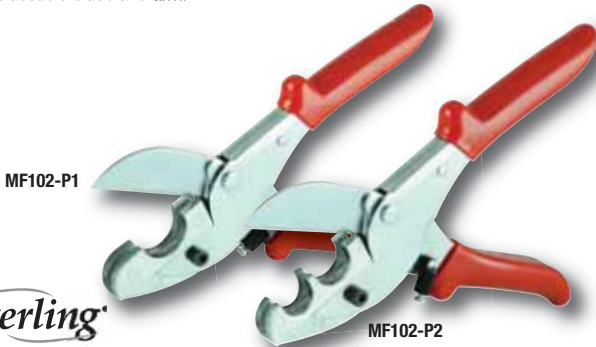

## Sterling® Tube Cutters

### SINGLE & DOUBLE TUBE CUTTERS

| CODE            | DESCRIPTION                        | BOX QTY | CTN QTY |
|-----------------|------------------------------------|---------|---------|
| <b>MF102-P1</b> | Single Tube Cutter - up to 25mm    | 6       | 36      |
| <b>MF102-P2</b> | Double Tube Cutter - 16mm and 19mm | 6       | 36      |

- Comfortable handles
- Extra tough construction
- Replaceable blades & anvil
- Ideal for electrical conduit, pipes and hose uses.
- Replacement blades code: 3104 B
- Anvil codes: 3104A-P1 – Single Hole  
3104A-P2 – Double Hole



## Sterling® 3106 Swivel Base

### SWIVEL BASE HEAVY DUTY MITRE SHEARS

| CODE         | DESCRIPTION            | BOX QTY | CTN QTY |
|--------------|------------------------|---------|---------|
| <b>3106</b>  | Shears Bulk            | 6       | 48      |
| <b>3104B</b> | Replacement Blade Bulk | 1       | 1       |

- Max cutting length - 50mm
- Jaw height - 40mm Graduated base plate and swivel base guide for accurate repeat cuts
- Heavy duty construction for durability
- Two tone rubber grip handles for increased comfort
- Replaceable blade



## Sterling® 3108 Ratchet

### RATCHET HEAVY DUTY MITRE SHEARS

| CODE         | DESCRIPTION               | BOX QTY | CTN QTY |
|--------------|---------------------------|---------|---------|
| <b>3108</b>  | Shears Carded with Anvils | 6       | 48      |
| <b>3108B</b> | Replacement Blade         | 1       | 1       |
| <b>3108A</b> | Replacement Anvil Bulk    | 1       | 1       |

- Max cutting length - 55mm
- Jaw height - 60mm
- Ratchet action for cutting tougher or larger materials
- Cuts commercial gripper and larger timber and PVC moldings
- Graduated base plate for accurate angle cuts
- Extra heavy duty durability
- Supplied with a set of 4 anvils





Sterling®

## MP-342 Duck Bill

**7" DUCKBILL NAPPING SHEARS**

| CODE          | DESCRIPTION | BOX QTY | CTN QTY |
|---------------|-------------|---------|---------|
| <b>MP-342</b> | 175mm Boxed | 1       | 1       |

- 175mm (7") duckbill napping shears
- Red PVC coated handles
- Manufactured in EU



Sterling®

## MP-400 Offset

**8" OFFSET NAPPING SHEARS**

| CODE          | DESCRIPTION | BOX QTY | CTN QTY |
|---------------|-------------|---------|---------|
| <b>MP-400</b> | 200mm Boxed | 1       | 1       |

- 200mm (8") offset napping shears
- Soft grip handles for comfort
- Adjustable tension pivot bolt for easy resharpening

## 29-740 Magic Snips



Sterling®

**MAGIC PLASTIC ANVIL SNIPS**

| CODE           | DESCRIPTION | BOX QTY | CTN QTY |
|----------------|-------------|---------|---------|
| <b>29-740Y</b> | Yellow Bulk | 24      | 192     |
| <b>29-740B</b> | Black Bulk  | 36      | 216     |

- Plastic anvil snips to prevent sparks and minimise electrical conductivity
- Ground stainless steel blades for excellent cutting capacity
- Light & compact for easy use
- Spring loaded with safety lock
- Ideal for cutting shot-cord, Detcard® & explosive wiring
- Manufactured in EU

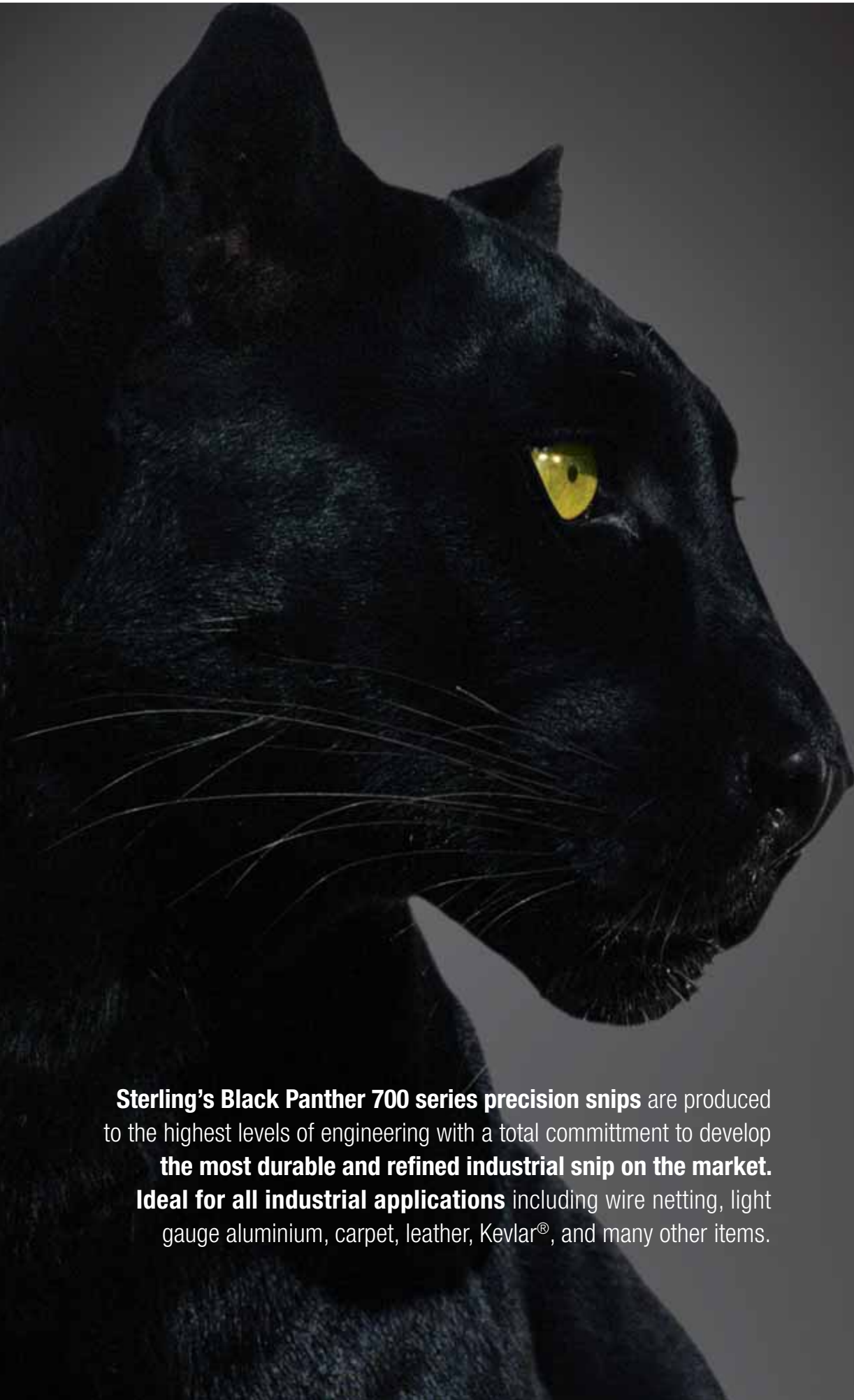

**Sterling's Black Panther 700 series precision snips** are produced to the highest levels of engineering with a total commitment to develop **the most durable and refined industrial snip on the market.** **Ideal for all industrial applications** including wire netting, light gauge aluminium, carpet, leather, Kevlar<sup>®</sup>, and many other items.

Strong & spirited  
Snips



Multiple cutting applications - from thin wire to Kevlar®

## 29-701 Black Panther



**Sterling®**

### BLACK PANTHER SNIPS – 7”

| CODE          | DESCRIPTION                | BOX QTY | CTN QTY |
|---------------|----------------------------|---------|---------|
| <b>29-701</b> | Black Carded               | 12      | 72      |
| <b>29-704</b> | Blunt Point - Black Carded | 12      | 72      |

- 185mm (7”) black handled snips
- Comfort grip ergonomically designed handles
- Stainless Steel serrated edge blades for increased cutting capacity
- Ideal for multiple applications from thin wire to Kevlar®
- Ideal knife replacement tool
- 29-704 with rounded points for extra safety
- Sturdy nylon holster available - Code STC65 - See pg. 153

*Kevlar® is a registered trademark of DuPont or its affiliates.*



**Carded**

# SNIPS

# 107

**Sterling®**

**INDUSTRIAL & TIN SNIPS**



## Sterling® 29-700 Black Panther

### BLACK PANTHER SNIPS – 8” LONG CUT

| CODE          | DESCRIPTION  | BOX QTY | CTN QTY |
|---------------|--------------|---------|---------|
| <b>29-700</b> | Black Carded | 12      | 72      |

- 200mm (8”) black handled snips
- Comfort grip ergonomically designed handles
- Stainless Steel serrated edge blades for increased cutting capacity
- Ideal for tough sheet materials
- Ideal for multiple applications



Carded



## Sterling® 29-503 Electrical

### BLACK PANTHER ELECTRICAL SCISSORS - 5”

| CODE          | DESCRIPTION               | BOX QTY | CTN QTY |
|---------------|---------------------------|---------|---------|
| <b>29-503</b> | 140mm (5-1/4”) Red Carded | 6       | 72      |

- 140mm (5-1/4”) Black Panther electrical scissors
- Hi-Tensile Stainless Steel serrated edge blades for superior cutting capacity
- Comfort grip handles
- For cutting fine electrical wires, Kevlar® strand and fishing twine



Carded



## Sterling® 29-702 Hi-Tensile

### HI-TENSILE BLACK PANTHER SNIPS - 7”

| CODE          | DESCRIPTION | BOX QTY | CTN QTY |
|---------------|-------------|---------|---------|
| <b>29-702</b> | Red Carded  | 12      | 72      |

- 185mm (7”) red handled snips with Hi-Tensile blades
- Comfort grip ergonomic handles
- High tensile Stainless Steel serrated edge blades for superior durability
- Ideal for wire, Kevlar®, electrical applications, etc.



Carded



## Sterling® Industrial Snip Counter Display

| CODE            | DESCRIPTION                 | BOX QTY | CTN QTY |
|-----------------|-----------------------------|---------|---------|
| <b>29-7DISP</b> | Complete Display with Stock | 1       | 1       |

- 12 x 29-701 7” Snips
- 6 x 29-700 8” Snips
- 6 x 29-702 7” Hi-Tensile Snips
- Counter display supplied with bonus trial snip attached
- Display footprint 315 x 310mm

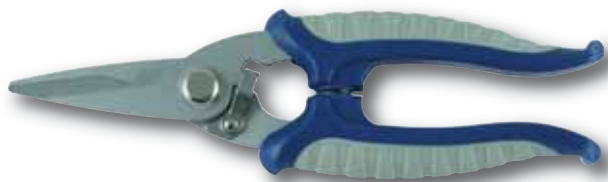

## Sterling® 29-703 Multi-Purpose

### 7" MULTI-PURPOSE SNIPS

| CODE          | DESCRIPTION      | BOX QTY | CTN QTY |
|---------------|------------------|---------|---------|
| <b>29-703</b> | Blue/Grey Carded | 10      | 100     |

- 185mm (7") multi-purpose snips
- Suitable for light duty cutting



## Sterling® Tin Snips

### TRADITIONAL TIN SNIP 8" 10" 12" & 14"

| CODE          | DESCRIPTION          | BOX QTY | CTN QTY |
|---------------|----------------------|---------|---------|
| <b>29-708</b> | 8" Tin Snips Carded  | 6       | 48      |
| <b>29-710</b> | 10" Tin Snips Carded | 6       | 36      |
| <b>29-712</b> | 12" Tin Snips Carded | 6       | 24      |
| <b>29-714</b> | 14" Tin Snips Carded | 6       | 24      |

- Traditional style straight cut tin snips
- Drop forged high carbon steel with hardened cutting edges for maximum performance
- Comfortable vinyl coated handles

Carded



## Sterling® 29-707 Jewellers

### JEWELLERS SNIPS - 7"

| CODE          | DESCRIPTION        | BOX QTY | CTN QTY |
|---------------|--------------------|---------|---------|
| <b>29-707</b> | 7" Straight Carded | 20      | 120     |

- 7" (180mm) jewellers snips for detailed cutting
- One piece drop forged construction
- Hardened cutting edges for maximum performance

Carded



## Sterling® 29-772 Pelican

### PELICAN SNIPS - 12"

| CODE          | DESCRIPTION  | BOX QTY | CTN QTY |
|---------------|--------------|---------|---------|
| <b>29-772</b> | Metal Carded | 6       | 24      |

- 12" (300mm) Pelican style snips
- Traditional European style
- Drop forged high carbon steel construction
- Hardened cutting edges 58-60 HRC

Carded





## Aviation Tin Snips



**Left Cut**  
Red Handle



**Right Cut**  
Green Handle



**Hangable holsters**

**Straight Cut**  
Yellow Handle



| CODE          | DESCRIPTION           | BOX QTY | CTN QTY |
|---------------|-----------------------|---------|---------|
| <b>29-751</b> | Left Cut - Red        | 6       | 36      |
| <b>29-752</b> | Right Cut - Green     | 6       | 36      |
| <b>29-753</b> | Straight Cut - Yellow | 6       | 36      |

- Drop forged molybdenum alloy blades induction hardened for long life
- Cuts up to 1.5mm cold rolled steel or 1.0mm Stainless Steel
- Hi-Tensile pivot bolt for maximum durability
- Squeeze quick-release handle catch
- TPR rubber grip handles for extra comfort
- FREE Plastic Belt Holster



## 29-756 Long Cut

### AVIATION TIN SNIPS – LONG CUT

| CODE          | DESCRIPTION  | BOX QTY | CTN QTY |
|---------------|--------------|---------|---------|
| <b>29-756</b> | Straight Cut | 6       | 36      |

- Drop forged molybdenum alloy blades induction hardened for long life
- Cuts up to 1.0mm cold rolled steel or 0.96mm Stainless Steel
- Hi-Tensile Pivot bolt for extra durability
- Squeeze quick release handle catch
- Full 75mm (3") cutting length, 290mm overall length
- FREE Plastic Belt Holster



**Hangable holsters**



## Sterling® Aviation Snip Counter Display

| CODE              | DESCRIPTION                 | BOX QTY | CTN QTY |
|-------------------|-----------------------------|---------|---------|
| <b>29-751DISP</b> | Complete Display with Stock | 1       | 1       |

- 12 x 29-751 Red Left Cut
- 12 x 29-752 Green Right Cut
- 12 x 29-753 Yellow Straight Cut
- Display footprint 300 x 200mm

# Offset Tin Snips



Hangable holsters

**Sterling**

## TIN SNIPS

| CODE          | DESCRIPTION       | BOX QTY | CTN QTY |
|---------------|-------------------|---------|---------|
| <b>29-765</b> | Left Cut - Red    | 6       | 36      |
| <b>29-766</b> | Right Cut - Green | 6       | 36      |

- Drop forged molybdenum alloy blades induction hardened for long life
- Cuts up to 1.5mm cold rolled steel or 1.0mm Stainless Steel
- Squeeze quick-release handle catch
- FREE Plastic Belt Holster
- TPR rubbergrip handles for comfort

**Sterling**

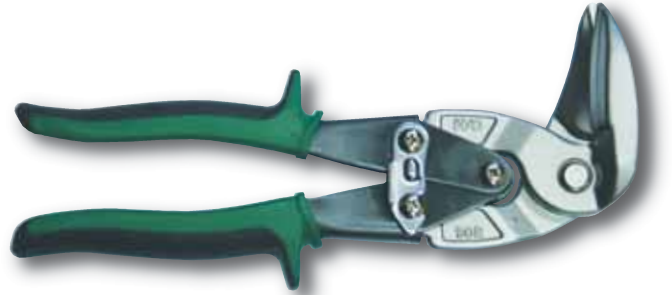

## Sterling 29-776 Upright

### UPRIGHT TIN SNIPS - RIGHT CUT

| CODE          | DESCRIPTION       | BOX QTY | CTN QTY |
|---------------|-------------------|---------|---------|
| <b>29-776</b> | Right Cut - Green | 6       | 36      |

- Drop forged Molybdenum alloy blades
- Upright design for cutting in difficult access situations
- Induction hardened for long life
- Blades meet precisely at point allowing accurate cuts
- Compound leverage
- Serrated edges, no slipping
- Safety auto latch
- FREE plastic holster



Hangable holsters

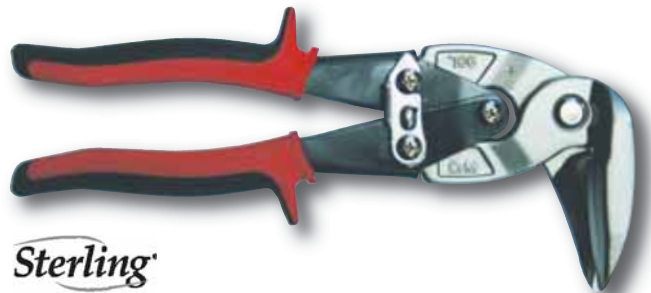

## Sterling 29-775 Upright

### UPRIGHT TIN SNIPS - LEFT CUT

| CODE          | DESCRIPTION    | BOX QTY | CTN QTY |
|---------------|----------------|---------|---------|
| <b>29-775</b> | Left Cut - Red | 6       | 36      |

- Drop forged Molybdenum alloy blades
- Upright design for cutting in difficult access situations
- Induction hardened for long life
- Blades meet precisely at point allowing accurate cuts
- Compound leverage
- Serrated edges, no slipping
- Safety auto latch
- FREE plastic holster



Hangable holsters

# Dual action!

**Sterling Black Panther** shears are **premium tailoring scissors of exceptional quality**. Featuring **supremely sharp stainless steel blades** and **ambidextrous comfort grip handles**, these shears glide through tailoring, upholstery and fibreglass industry applications.



Supremely sharp stainless steel blades



One knife edge and one serrated edge blade



Ambidextrous comfort grip handles



*Sterling*<sup>®</sup>





# Serrated Edge Tailoring



**Sterling®**

## BLACK PANTHER SERRATED EDGE TAILORING SHEARS - 11"/12"

| CODE   | DESCRIPTION        | BOX QTY | CTN QTY |
|--------|--------------------|---------|---------|
| 29-915 | 280mm (11") Carded | 1       | 36      |
| 29-916 | 300mm (12") Carded | 1       | 36      |

- Premium quality tailoring shears
- Ambidextrous comfort grip handles
- Supremely sharp Stainless Steel blades
- One knife edge blade and one serrated edge blade
- Ideal for tailoring, upholstery & fibreglass industries

**Carded**



# Knife Edge Tailoring



**Sterling®**

## BLACK PANTHER KNIFE EDGE TAILORING SHEARS - 11"/12"

| CODE   | DESCRIPTION        | BOX QTY | CTN QTY |
|--------|--------------------|---------|---------|
| 29-911 | 280mm (11") Carded | 1       | 36      |
| 29-912 | 300mm (12") Carded | 1       | 36      |

- Premium quality tailoring shears
- Ambidextrous comfort grip handles
- Supremely sharp smooth knife edge Stainless Steel blades
- Ideal for tailoring, upholstery & industrial applications

**Carded**



# Shears



**Sterling®**  
29-902 Tailoring

**BLACK PANTHER TAILORING SHEARS - 10"**

| CODE   | DESCRIPTION        | BOX QTY | CTN QTY |
|--------|--------------------|---------|---------|
| 29-902 | 250mm (10") Carded | 1       | 36      |

- 250mm (10") black handled tailoring shears
- Precision smooth knife edge Stainless Steel blades
- Ergonomically moulded handles for comfort



Carded



**Sterling®** 29-802  
Kitchen Shears

**BLACK PANTHER KITCHEN SHEARS - 8"**

| CODE   | DESCRIPTION       | BOX QTY | CTN QTY |
|--------|-------------------|---------|---------|
| 29-802 | 205mm (8") Carded | 12      | 72      |

- Ambidextrous handles
- 205mm (8") black handled
- Serrated edge Stainless Steel blades
- Bottle and lid openers



Carded



Knife Edge

**Sterling®**

**BLACK PANTHER KNIFE EDGE SHEARS - 8"/9"**

| CODE   | DESCRIPTION       | BOX QTY | CTN QTY |
|--------|-------------------|---------|---------|
| 29-810 | 220mm (8") Carded | 12      | 72      |
| 29-910 | 245mm (9") Carded | 12      | 72      |

- Ambidextrous comfort grip handles
- Extra large lower bow for gloved hands
- Precision smooth knife edge Stainless Steel blades
- Ideal for industrial, tailoring & stationery applications



Carded

Serrated



**BLACK PANTHER – SERRATED EDGE SHEARS - 8”/9”**

| CODE          | DESCRIPTION       | BOX QTY | CTN QTY |
|---------------|-------------------|---------|---------|
| <b>29-800</b> | 210mm (8”) Carded | 12      | 72      |
| <b>29-900</b> | 235mm (9”) Carded | 12      | 72      |

- Ambidextrous comfort grip handles
- One knife edge blade and one serrated edge blade
- Stainless Steel blades for durability
- Ideal for all industrial, food processing & stationery applications



Carded



**Sterling® 29-501  
Black Panther**

**BLACK PANTHER STATIONERY SCISSORS - 5”**

| CODE          | DESCRIPTION       | BOX QTY | CTN QTY |
|---------------|-------------------|---------|---------|
| <b>29-501</b> | 135mm (5”) Carded | 12      | 192     |

- 135mm (5”) super deluxe stationery scissors
- Molded comfort grip handles
- Serrated edge Stainless Steel blades



Carded



**Sterling® 29-603  
Black Panther**

**BLACK PANTHER STATIONERY SCISSORS - 6”**

| CODE          | DESCRIPTION       | BOX QTY | CTN QTY |
|---------------|-------------------|---------|---------|
| <b>29-603</b> | 160mm (6”) Carded | 12      | 192     |

- 160mm (6”) super deluxe stationery scissors
- Moulded comfort grip handles
- Serrated edge Stainless Steel blades



Carded



## Sterling® Carpet Shears

### BLACK PANTHER CARPET SHEARS - 10"

| CODE          | DESCRIPTION                 | BOX QTY | CTN QTY |
|---------------|-----------------------------|---------|---------|
| <b>29-904</b> | 250mm (10") Serrated Carded | 6       | 48      |

- Stainless Steel serrated edge blade
- Angled handles keep hands above carpet and other sheet materials



Carded



## Sterling® 8" Forged Tailoring

### FORGED TAILORING SHEARS - 8"

| CODE           | DESCRIPTION                              | BOX QTY | CTN QTY |
|----------------|--|---------|---------|
| <b>78-407</b>  | 8" (200mm) Smooth Blade Boxed            | 1       | 1       |
| <b>78-408</b>  | 8" (200mm) <i>Serrated</i> Blade Boxed   | 1       | 1       |
| <b>78-408L</b> | 8" (200mm) <i>Left Hand</i> Smooth Boxed | 1       | 1       |

- Drop forged from cutlery carbon steel
- One knife edge blade and one serrated edge blade (78-408 only)
- Made in Europe to Sterling specifications



## Forged Tailoring

### Sterling®

### FORGED TAILORING SHEARS - 10"/12"

| CODE           | DESCRIPTION                               | BOX QTY | CTN QTY |
|----------------|---|---------|---------|
| <b>78-410</b>  | 10" (250mm) Forged w Stayset Pivot Boxed  | 1       | 1       |
| <b>78-410L</b> | 10" (250mm) <i>Left Hand</i> Forged Boxed | 1       | 1       |
| <b>78-412</b>  | 12" (300mm) Forged w Stayset Pivot Boxed  | 1       | 1       |

- Highest quality drop forged from cutlery carbon steel
- Stay set pivot allows for resharpening and tension adjustment
- Pointed blades for maximum accessibility
- Made in Europe to Sterling specifications

## Serrated Tailoring



Sterling®

**FORGED SERRATED EDGE TAILORING SHEARS 10"/12"**

| CODE          | DESCRIPTION                                 | BOX QTY | CTN QTY |
|---------------|---|---------|---------|
| <b>78-415</b> | 10" (250mm) Forged with Serrated Edge Boxed | 1       | 1       |
| <b>78-416</b> | 12" (300mm) Forged with Serrated Edge Boxed | 1       | 1       |

- Highest quality drop forged from cutlery carbon steel
- One knife edge blade and one serrated edge blade for cutting Synthetic materials
- Adjustable pivot for resharpening
- Made in Europe to Sterling specifications



Sterling®

## Tailoring Shears

**TAILORING SHEARS - 8"/ 10"/ 12"**

| CODE           | DESCRIPTION                          | BOX QTY | CTN QTY |
|----------------|--------------------------------------|---------|---------|
| <b>TSS-10</b>  | 10" (250mm) Boxed                    | 1       | 1       |
| <b>TSS-12L</b> | 12" (300mm) Left Handed Boxed        | 1       | 1       |
| <b>TSS-12</b>  | 12" (300mm) Boxed                    | 1       | 1       |
| <b>TSS-10L</b> | 10" (250mm) <i>Left Handed</i> Boxed | 1       | 1       |

- Steel tailoring shears with red handles
- Smooth knife edge blades
- Adjustable pivot for resharpening
- Made in Europe



Sterling®

## Serrated Shears

**SERRATED TAILORING SHEARS - 10"/12"**

| CODE            | DESCRIPTION       | BOX QTY | CTN QTY |
|-----------------|-------------------|---------|---------|
| <b>TSSTS-10</b> | 10" (250mm) Boxed | 1       | 1       |
| <b>TSSTS-12</b> | 12" (300mm) Boxed | 1       | 1       |

- Steel tailoring shears with black handles
- One knife edge blade and one serrated edge blade
- Adjustable pivot for resharpening
- Made in Europe

## Tailoring - Left Handed



### FORGED TAILORING SHEARS - LEFT HANDED

| Code           | Description                  | Box Qty | Ctn Qty |
|----------------|------------------------------|---------|---------|
| <b>78-408L</b> | 8" <i>Left Handed</i> Boxed  | 1       | 1       |
| <b>78-410L</b> | 10" <i>Left Handed</i> Boxed | 1       | 1       |

- Drop forged from cutlery carbon steel
- Left handed with black handles
- Smooth knife edge blades
- Adjustable pivot for resharpening
- Made in Europe to Sterling specifications

## Shears - Left Handed



### TAILORING SHEARS - LEFT HANDED

| CODE           | DESCRIPTION                  | BOX QTY | CTN QTY |
|----------------|------------------------------|---------|---------|
| <b>TSS-10L</b> | 10" <i>Left Handed</i> Boxed | 1       | 1       |
| <b>TSS-12L</b> | 12" <i>Left Handed</i> Boxed | 1       | 1       |

- Stainless steel tailoring shears
- Left handed with red handles
- Smooth knife edge blades
- Adjustable pivot for resharpening



## Sterling® Black Panther Embroidery

### BLACK PANTHER EMBROIDERY SCISSORS

| CODE          | DESCRIPTION                 | BOX QTY | CTN QTY |
|---------------|-----------------------------|---------|---------|
| <b>29-506</b> | Blue Straight Blades Carded | 12      | 240     |
| <b>29-507</b> | Blue Curved Blades Carded   | 12      | 240     |

- 120mm (4-3/4") Embroidery Scissors
- Optional spring action with fold out spring
- Highest quality Stainless Steel blades for professional users
- Available with curved or straight blades

Carded



## Sterling® ES4405 Embroidery

### DELUXE EMBROIDERY SCISSORS

| CODE          | DESCRIPTION  | BOX QTY | CTN QTY |
|---------------|--------------|---------|---------|
| <b>ES4405</b> | Black Carded | 20      | 240     |

- 110mm (4-1/2") high quality embroidery scissors with black plastic handles



## Sterling® TC0123 Thread Snips

### ALL METAL DELUXE THREAD SNIPS

| CODE          | DESCRIPTION   | BOX QTY | CTN QTY |
|---------------|---------------|---------|---------|
| <b>TC0123</b> | Silver Carded | 1       | 1       |

- 115mm (4-1/2") high quality all steel thread snips
- Internal bearing for smooth operation



## Sterling® S-701 Thread Snips

### METAL THREAD SNIPS

| CODE         | DESCRIPTION | BOX QTY | CTN QTY |
|--------------|-------------|---------|---------|
| <b>S-701</b> | Blue Bulk   | 12      | 12      |

- 115mm (4-1/2") All metal thread snip with spring-form action



**Sterling<sup>e</sup>**  
9900 Pinking

**PINKING SCISSORS - 9"**

| CODE | DESCRIPTION | BOX QTY | CTN QTY |
|------|-------------|---------|---------|
| 9900 | 230mm Bulk  | 12      | 144     |

- 230mm (9") Pinking Scissors
- Moulded black plastic handles for comfortable grip



**Sterling®** LJ10685  
SmartEdge 220

**SMARTEDGE 220 SERRATED STATIONERY SCISSORS**

| CODE    | DESCRIPTION       | BOX QTY | CTN QTY |
|---------|-------------------|---------|---------|
| LJ10685 | 220mm (9") Carded | 12      | 120     |

- High quality deluxe general purpose office scissors
- Serrated edge blades and black plastic ergonomic handles



Carded



**Sterling®** LJ10660  
SmartEdge 160

**SMARTEDGE 160 SERRATED STATIONERY SCISSORS**

| CODE    | DESCRIPTION           | BOX QTY | CTN QTY |
|---------|-----------------------|---------|---------|
| LJ10660 | 160mm (6-1/2") Carded | 24      | 240     |

- High quality deluxe general purpose office scissors
- Serrated edge blades and black plastic ergonomic handles



Carded



**Sterling®** LJ10695  
SmartEdge 240

**SMARTEDGE 240 SERRATED STATIONERY SCISSORS**

| CODE    | DESCRIPTION           | BOX QTY | CTN QTY |
|---------|-----------------------|---------|---------|
| LJ10695 | 240mm (9-1/2") Carded | 12      | 120     |

- High quality deluxe office / dressmaking scissors
- Serrated edge blades and black plastic ergonomic handles



Carded





Sterling<sup>e</sup>

## SmartCut Scissors

### SMARTCUT - SCISSORS

| CODE        | DESCRIPTION           | BOX QTY | CTN QTY |
|-------------|-----------------------|---------|---------|
| <b>2005</b> | 140mm (5-1/2") Carded | 12      | 300     |
| <b>2006</b> | 155mm (6") Carded     | 12      | 300     |
| <b>2007</b> | 175mm (7") Carded     | 12      | 300     |

- Rubberised comfort grip scissors, blue handles with green rubber inserts
- Premium quality with double honed Stainless Steel blades and adjusting screw

Carded



Sterling<sup>e</sup>

## SmartCut Scissors

| CODE         | DESCRIPTION           | BOX QTY | CTN QTY |
|--------------|-----------------------|---------|---------|
| <b>20010</b> | 245mm (9-3/4") Carded | 12      | 180     |

- Rubberised comfort grip scissors, blue handles with green rubber inserts
- Premium quality with double honed Stainless Steel blades and adjusting screw

Carded



## SmartCut Scissors

Sterling<sup>e</sup>

| CODE        | DESCRIPTION           | BOX QTY | CTN QTY |
|-------------|-----------------------|---------|---------|
| <b>2008</b> | 195mm (7-3/4") Carded | 12      | 180     |
| <b>2009</b> | 215mm (8-1/2") Carded | 12      | 180     |

- Rubberised comfort grip scissors, blue handles with green rubber inserts
- Premium quality with double honed Stainless Steel blades and adjusting screw

Carded



**Sterling**



**Sterling** 30007  
SmartChoice  
Enviro



| CODE  | DESCRIPTION                              | BOX QTY | CTN QTY |
|-------|--|---------|---------|
| 30007 | 178mm (7") Sterling SMARTCHOICE Scissors | 6       | 180     |

- 100% Recycled content 100% renewable
- Planet Friendly upon correct disposal
- 3rd Party Verification of recycled contents
- Stainless Steel Blades
- Sharp, lightweight and comfortable
- Recycled handles & blades reduce carbon footprint
- Ergonomic handles for comfort
- Carded for retail display

Carded



**Sterling** 30008  
SmartChoice  
Enviro



| CODE  | DESCRIPTION                              | BOX QTY | CTN QTY |
|-------|--|---------|---------|
| 30008 | 203mm (8") Sterling SMARTCHOICE Scissors | 6       | 180     |

- 100% Recycled content 100% renewable
- Planet Friendly upon correct disposal
- 3rd Party Verification of recycled contents
- Stainless Steel Blades
- Sharp, lightweight and comfortable
- Recycled handles & blades reduce carbon footprint
- Ergonomic handles for comfort
- Carded for retail display

Carded



30009 SmartChoice  
Enviro

**Sterling**



| CODE  | DESCRIPTION                              | BOX QTY | CTN QTY |
|-------|--|---------|---------|
| 30009 | 229mm (9") Sterling SMARTCHOICE Scissors | 6       | 180     |

- 100% Recycled content 100% renewable
- Planet Friendly upon correct disposal
- 3rd Party Verification of recycled contents
- Stainless Steel Blades
- Sharp, lightweight and comfortable
- Recycled handles & blades reduce carbon footprint
- Ergonomic handles for comfort
- Carded for retail display

Carded



## 626 Tortoise Shell

**6 1/4" OFFICE SCISSORS**

| CODE       | DESCRIPTION                | BOX QTY | CTN QTY |
|------------|----------------------------|---------|---------|
| <b>626</b> | 6 1/4" Tortoise Shell Bulk | 12      | 240     |

- 155mm (6 1/4") office scissors
- Right handed with tortoise coloured handles
- Fully ground Stainless Steel blades with rounded points



## 706 Tortoise Shell

**7 1/4" STUDENT SCISSORS**

| CODE       | DESCRIPTION                | BOX QTY | CTN QTY |
|------------|----------------------------|---------|---------|
| <b>706</b> | 7 1/4" Tortoise Shell Bulk | 12      | 240     |

- 180mm (7 1/4") office scissors
- Right handed with tortoise coloured handles
- Fully ground Stainless Steel blades



## 806 Tortoise Shell

**8 1/2" OFFICE SCISSORS**

| CODE       | DESCRIPTION                | BOX QTY | CTN QTY |
|------------|----------------------------|---------|---------|
| <b>806</b> | 8 1/2" Tortoise Shell Bulk | 12      | 240     |

- 215mm (8 1/2") office scissors
- Right handed with tortoise coloured handles
- Fully ground Stainless Steel blades with rounded points

A silhouette of a group of about ten people standing on the edge of a dark, jagged cliff. The background is a bright, hazy orange and yellow sky, suggesting a sunset or sunrise. The cliff edge is on the left, and the sea is visible in the distance on the right.

You've got the edge

The **Sterling 50001 Art Knife** is a versatile knife with a **screw down locking chuck** which eliminates blade movement. **A useful knife for a range of graphic applications.**



Supplied with safety cap to prevent injury



Unscrew for easy blade change

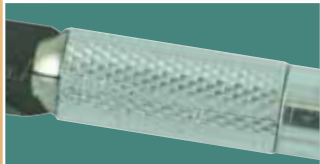

Knurled finger grips for superior control

# 50001 Art Knife



**Sterling®**

## LIGHT DUTY NO.1 PRECISION ART KNIFE

| CODE         | DESCRIPTION   | BOX QTY | CTN QTY |
|--------------|---------------|---------|---------|
| <b>50001</b> | Silver Carded | 12      | 480     |

Takes craft blade No.s 01-101, 01-111, 01-161, 01-173. See pgs. 201-202.

- Supplied with safety cap to prevent injury
- Strong metal blade holding chuck is durable and eliminates movement
- Knurled finger grip for superior control

Suggested replacement blades:



See pgs. 201-202



**Carded**

# graphic 125

**Sterling®**



## Techni-edge 50002-No.2

### MEDIUM DUTY PRECISION ART KNIFE

| CODE  | DESCRIPTION   | BOX QTY | CTN QTY |
|-------|---------------|---------|---------|
| 50002 | Silver Carded | 12      | 12      |

- Supplied with safety cap to prevent injury
- Strong metal blade holding chuck is durable and eliminates movement
- Takes both router blades and larger shank craft blades

Takes craft blade No.s:



See pgs. 202 - 203

Carded



## Techni-edge 50003-No.3

### PEN KNIFE LIGHT DUTY PRECISION ART KNIFE

| CODE  | DESCRIPTION  | BOX QTY | CTN QTY |
|-------|--------------|---------|---------|
| 50003 | Black Carded | 12      | 12      |

- Supplied with lock-on cap and pocket clip for safety and convenience
- Supplied with No.10 rounded craft blade

Takes craft blade No.s:



See pgs. 201 - 202



## Techni-edge 50004-No.4

### SWIVEL PRECISION ART KNIFE

| CODE   | DESCRIPTION                 | BOX QTY | CTN QTY |
|--------|-----------------------------|---------|---------|
| 50004  | Silver Carded               | 12      | 12      |
| 01-092 | Replacement Blade Card of 2 | 12      | 12      |

- Supplied with safety cap to prevent injury
- Swivel blade is ideal for curved cutting work

Replacement blade 01-092



Carded



## Techni-edge 50005-No.5

### HEAVY DUTY PRECISION ART KNIFE

| CODE  | DESCRIPTION | BOX QTY | CTN QTY |
|-------|-------------|---------|---------|
| 50005 | Red Carded  | 12      | 12      |

- Supplied with safety cap to prevent injury
- Strong Metal blade holding chuck is durable and eliminates movement
- Takes both router blades and large shank craft blades
- Large plastic grip provides better hold for heavier cutting jobs

Takes craft blade No.s:

Carded

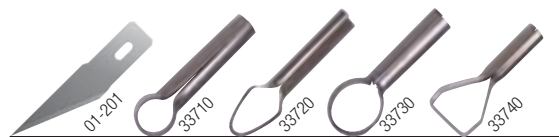

See pgs. 202, 203, 206





## Swann-Morton 2800 Retractaway

### RETRACTAWAY NO. 3 SCALPEL HANDLE

| CODE        | DESCRIPTION   | BOX QTY | CTN QTY |
|-------------|---------------|---------|---------|
| <b>2800</b> | Silver Bulk   | 10      | 10      |
| <b>2801</b> | Silver Carded | 10      | 10      |

Takes scalpel blade No.s 6, 10, 10A, 11, 14, 15, 16. *See pg. 217*

\*NB. 2800 not supplied with blade

- The professional graphic artist's knife from Swann Morton
- Safer than a conventional scalpel handle as the blade can be fully retracted
- Offers the precision of a scalpel blade with the No.3 fitment
- Made in England



## BLR Blade Remover

### BLADE REMOVER - BLUE BULK

| CODE       | DESCRIPTION | BOX QTY | CTN QTY |
|------------|-------------|---------|---------|
| <b>BLR</b> | Blue Bulk   | 10      | 100     |

- Safely remove and dispose of used scalpel blades

## Scalpel Handles



### SCALPEL HANDLE NO.3 & NO.4 FITMENTS

| CODE          | DESCRIPTION          | BOX QTY | CTN QTY |
|---------------|----------------------|---------|---------|
| <b>No.3SM</b> | Nickel Alloy Bulk    | 10      | 10      |
| <b>No.3SS</b> | Stainless Steel Bulk | 10      | 50      |

Takes scalpel blade No.s 6-16. *See pg. 217.*

| CODE          | DESCRIPTION          | BOX QTY | CTN QTY |
|---------------|----------------------|---------|---------|
| <b>No.4SM</b> | Nickel Alloy Bulk    | 10      | 10      |
| <b>No.4SS</b> | Stainless Steel Bulk | 10      | 50      |

Takes blade scalpel No.s 20-26. *See pg. 218*

\*NB. No.3 & No.4 handles not supplied with blade

- Available in high quality surgical nickel alloy or Stainless Steel
- No.3 & No.4 fitments

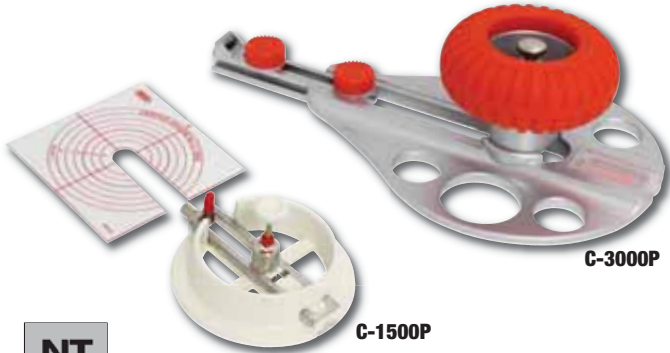

**NT**

## Circle Cutters

### NT CIRCLE CUTTERS

| CODE            | DESCRIPTION                                  | BOX QTY | CTN QTY |
|-----------------|--|---------|---------|
| <b>C-1500P</b>  | NT Circle Cutter - Holes 30-170mm            | 1       | 10      |
| <b>C-3000GP</b> | NT Heavy-Duty Circle Cutter - Holes 30-260mm | 1       | 10      |
| <b>CE-700P</b>  | Extension Bar suits C-1500P & C-3000GP       | 1       | 10      |

- Ideal for accurate circle cutting in thin materials
- Cuts up to 40cm diameter with extension bar
- C-1500P leaves no centre mark
- C-3000GP Cuts carpet, etc

Replacement blade BDC-200 or BDA-200



C-1500P  
**Carded**

C-3000GP  
**Carded**



See pg. 189



**NT**

## D-1000

| CODE          | DESCRIPTION   | PRICE EA | CTN QTY |
|---------------|---------------|----------|---------|
| <b>D-1000</b> | Silver Carded | 10       | 100     |

Takes blade BDC-200

- High quality aluminum construction
- Double ended art knife blade at one end and pin at the other
- Supplied with pocket clip

Replacement blade BDC-200 or BDA-200



See pg. 189

**Carded**



## KDS D-12GR Easy-Grip

### EASY-GRIP PRECISION ART KNIFE

| CODE          | DESCRIPTION                       | BOX QTY | CTN QTY |
|---------------|-----------------------------------|---------|---------|
| <b>D-12GR</b> | Green Carded                      | 10      | 200     |
| <b>DB-48</b>  | Precision Art Blades - Pack of 48 | 10      | 100     |

- Precision art knife for all graphic artwork
- Soft grip barrel is comfortable to use
- Metal blade holder with plastic cap
- Body holds spare blades
- Supplied with 16 pcs spare blades

Replacement blade DB-48



**Carded**



## Swann-Morton SMOR Keyhole Knife

| CODE        | DESCRIPTION | BOX QTY | CTN QTY |
|-------------|-------------|---------|---------|
| <b>SMOR</b> | Red Bulk    | 10      | 10      |

Takes keyhole blade No.s 401, 404, 405, 406. See pg. 192

NB. Handle not supplied with blade

- The retractable technician's knife from Swann Morton offers a safe solution for precision cutting
- Ideal for heavy duty craft and carving applications taking the heavier duty keyhole blades
- Made in Sheffield England

Replacement blades:



See pgs. 204 - 205





# 30607-No.7

## 7/16" POUNCE WHEEL

| CODE  | DESCRIPTION   | BOX QTY |
|-------|---------------|---------|
| 30607 | Silver Carded | 12      |

- 7/16" Pounce wheel
- Swivel end for curved work or lockable for straight work
- Ideal for tracing patterns

Carded



# CVT Lino Tools

## LINO CARVING TOOLS

| CODE   | DESCRIPTION    | BOX QTY | CTN QTY |
|--------|----------------|---------|---------|
| CVT-V1 | Bulk Small V   | 50      | 1200    |
| CVT-V2 | Bulk Large V   | 50      | 1200    |
| CVT-U1 | Bulk Small U   | 50      | 1200    |
| CVT-U2 | Bulk Medium U  | 50      | 1200    |
| CVT-U3 | Bulk Large U   | 50      | 1200    |
| CVT-U4 | Bulk X-Large U | 50      | 1200    |
| CVT-P  | Bulk Pin       | 50      | 1200    |

- High carbon steel blades with timber handles
- Can be resharpened
- Blade shapes available in boxes of 50 pieces

# CVT-6 Lino Set



## LINO SET OF 6 CARVING TOOLS

| CODE  | DESCRIPTION    | BOX QTY | CTN QTY |
|-------|----------------|---------|---------|
| CVT-6 | Plastic Wallet | 20      | 160     |

- Contains V1, V2, U1, U2, U3 and U4 tools in a convenient set
- High carbon steel blades with timber handles
- Can be resharpened



The **Sterling RCM Rhino Cutting mats** are the **ideal cutting surface** and offer **excellent protection for tables and work benches**. Designed for frequent cutting, these mats are exceptionally durable and are **opaque with a grid underlay** to aid cutting accuracy.

Thick skinned





Cutting surface provides excellent protection



Opaque cutting surface with grid underlay

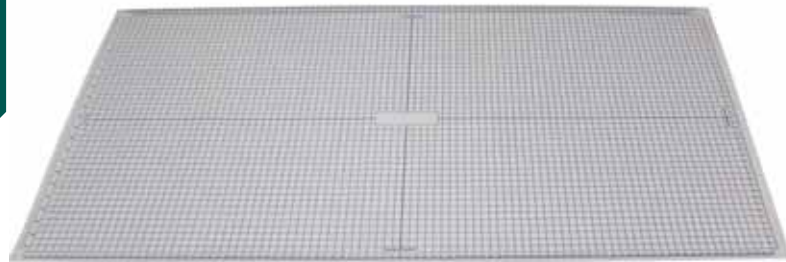

## Rhino Mat

### RHINO CUTTING MATS

| CODE           | DESCRIPTION             | BOX QTY | CTN QTY |
|----------------|-------------------------|---------|---------|
| <b>RCM4X8</b>  | 4'x 8' (1200 x 2400mm)  | 1       | 1       |
| <b>RCM4X10</b> | 4'x 10' (1200 x 3000mm) | 1       | 1       |
| <b>RCM4X12</b> | 4'x 12' (1200 x 3600mm) | 1       | 1       |
| <b>RCM5X8</b>  | 5'x 8' (1500 x 2400mm)  | 1       | 1       |
| <b>RCM5X10</b> | 5'x 10' (1500 x 3000mm) | 1       | 1       |
| <b>RCM5X12</b> | 5'x 12' (1500 x 3600mm) | 1       | 1       |
| <b>RCM6X10</b> | 6'x 10' (1800 x 3000mm) | 1       | 1       |
| <b>RCM6X12</b> | 6'x 12' (1800 x 3600mm) | 1       | 1       |

- Ideal cutting surface
- Protects cutting tables and work benches
- Opaque with grid underlay
- Range of sizes from 4'x8'(1200mmx2400mm) to 6' x 12' (1800 x 3600mm)

*Sterling*<sup>®</sup>

mats 131

CUTTING MATS

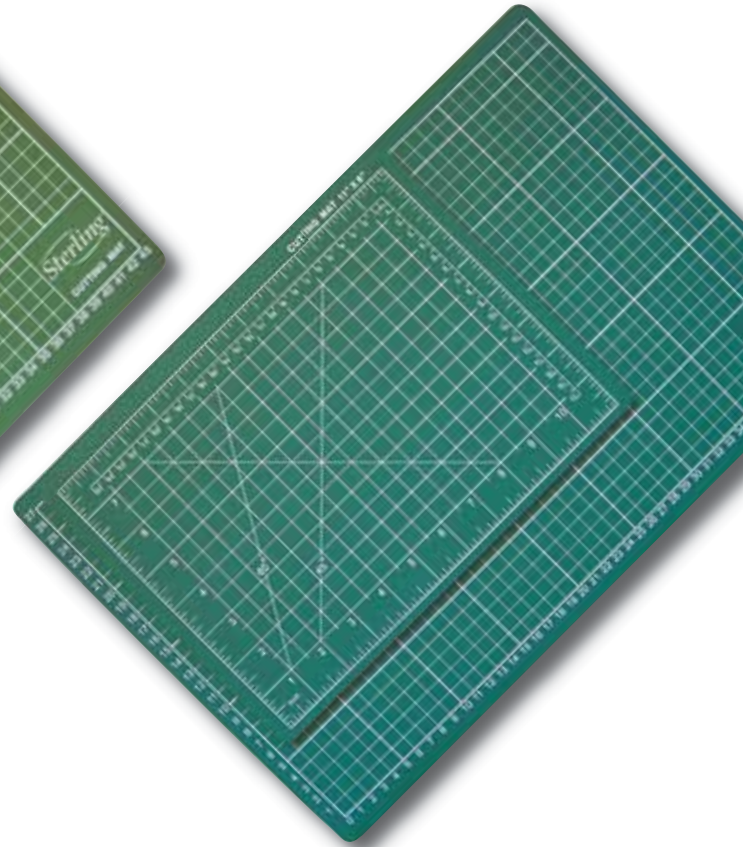
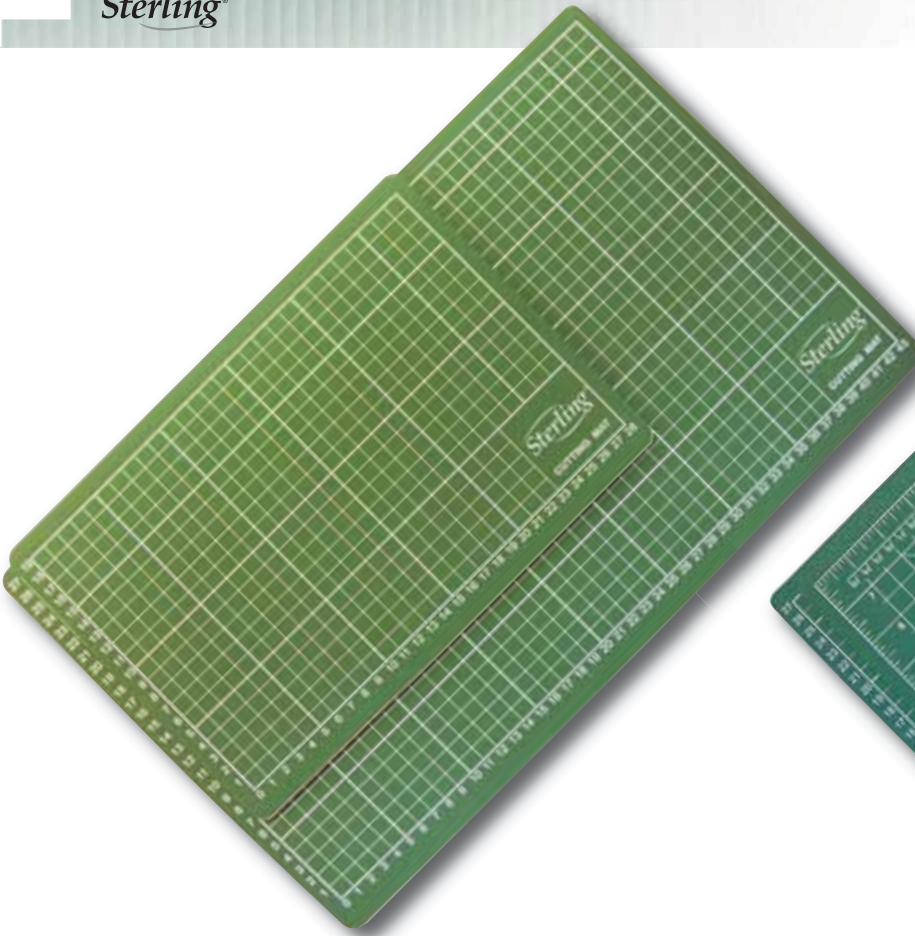

## Green Cutting Mats



### GREEN CUTTING MATS SELF HEALING

| CODE        | DESCRIPTION           | BOX QTY | CTN QTY |
|-------------|-----------------------|---------|---------|
| <b>A5G3</b> | Green A5 - 200x150mm  | 12      | 100     |
| <b>A4G3</b> | Green A4 - 300x220mm  | 12      | 72      |
| <b>A3G3</b> | Green A3 - 450x300mm  | 12      | 36      |
| <b>A2G3</b> | Green A2 - 600x450mm  | 12      | 24      |
| <b>A1G3</b> | Green A1 - 900x600mm  | 12      | 12      |
| <b>A0G3</b> | Green A0 - 1200x900mm | 6       | 6       |

- Self healing mat eliminates score marks
- Durable 3mm laminated construction with white centre
- Numbered up the side and across the bottom
- Clear metric grid markings - 3 layers useable from both sides

## Dual Measurement Cutting Mats



### DUAL SIDED CUTTING MATS

| CODE         | DESCRIPTION           | BOX QTY | CTN QTY |
|--------------|-----------------------|---------|---------|
| <b>A4G3D</b> | Green A4 - 300x220mm  | 12      | 72      |
| <b>A3G3D</b> | Green A3 - 450x300mm  | 12      | 36      |
| <b>A2G3D</b> | Green A2 - 600x450mm  | 12      | 24      |
| <b>A1G3D</b> | Green A1 - 900x600mm  | 12      | 12      |
| <b>A0G3D</b> | Green A0 - 1200x900mm | 6       | -       |

- Self healing cutting mat eliminates score marks
- Metric measurements one side, Imperial measurements the other side
- Durable 3mm laminated construction with white centre

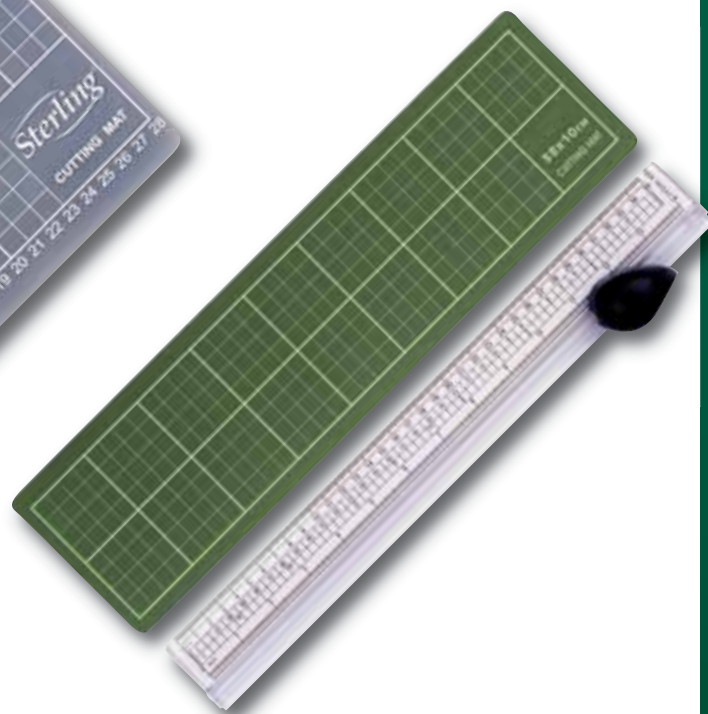
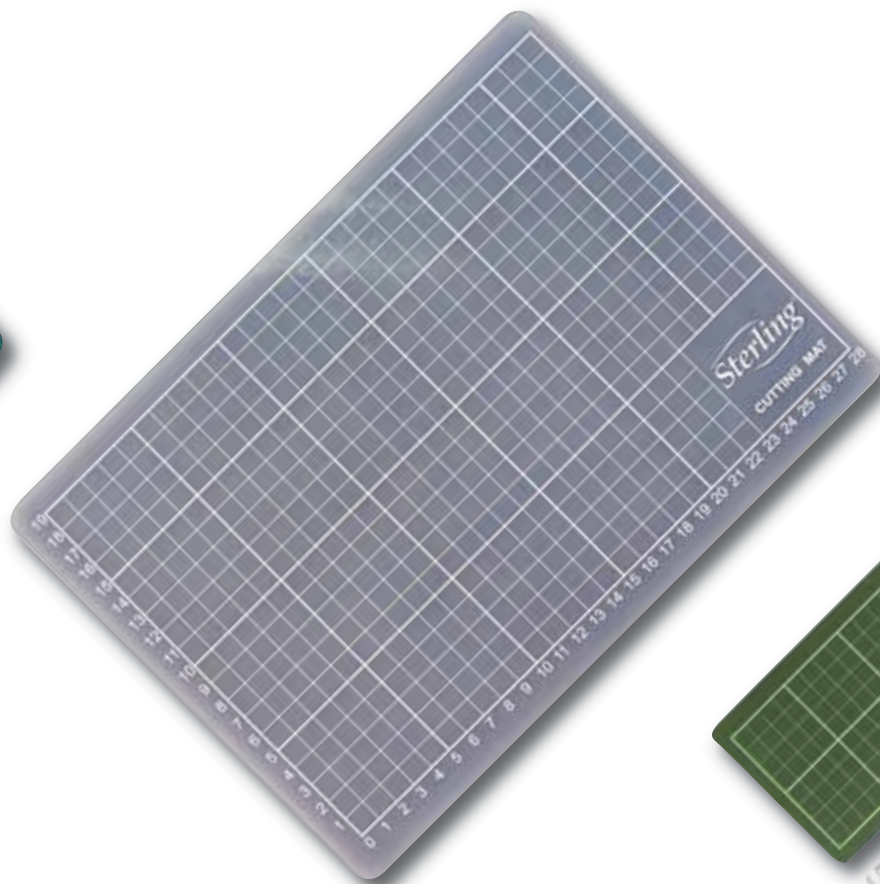

## Translucent Cutting Mats



### TRANSLUCENT CUTTING MATS

| CODE        | DESCRIPTION                | BOX QTY | CTN QTY |
|-------------|----------------------------|---------|---------|
| <b>A4T3</b> | Translucent A4 - 300x220mm | 12      | 72      |
| <b>A3T3</b> | Translucent A3 - 450x300mm | 12      | 36      |
| <b>A2T3</b> | Translucent A2 - 600x450mm | 12      | 24      |
| <b>A1T3</b> | Translucent A1 - 900x600mm | 12      | 12      |

- Translucent self healing cutting mats
- Clear metric grid markings
- Ideal for use on light boxes
- 3mm thick for durability

## 19015 Cutter Set



### ROTARY CUTTER SET WITH RULER AND CUTTING MAT SET

| CODE         | DESCRIPTION            | BOX QTY | CTN QTY |
|--------------|------------------------|---------|---------|
| <b>19015</b> | Carded - 380mm x 110mm | 6       | 60      |

- 380mm x 110mm cutting mat
- 350mm ruler with rotary cutter attached
- Cuts up to 5 pieces of paper

# Curves ahead

With **contoured, rubber-grip handle**, **sliding blade guard** and its easy rolling action, the **Sterling Rotary Roller Cutters** takes the curves with ease.



# RC02 28mm Rotary



**Sterling**

## 28MM ROTARY ROLLER CUTTER

| CODE        | DESCRIPTION   | BOX QTY | CTN QTY |
|-------------|---------------|---------|---------|
| <b>RC02</b> | Yellow Carded | 24      | 144     |

Replacement blade code RB-03 or SB-06. *See pg. 207.*

- Sliding blade guard to minimise injuries
- Rubber grip on back of handle
- Contoured handle for comfortable grip

Replacement blade RB-03 or SB-06  
*See pg. 207*



**Carded**

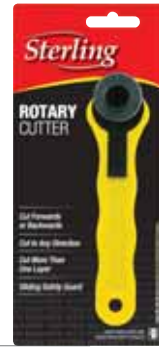

# RC12 45mm Rotary



**Sterling**

## 45MM ROTARY ROLLER CUTTER

| CODE        | DESCRIPTION   | BOX QTY | CTN QTY |
|-------------|---------------|---------|---------|
| <b>RC12</b> | Yellow Carded | 24      | 144     |

Replacement blade code RB-01. *See pg. 208.*

- Pull-back sliding blade guard to minimise injuries
- Rubber grip on back of handle
- Contoured handle for comfortable grip

Replacement blade RB-01  
*See pg. 208*



**Carded**

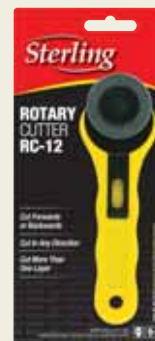

rotary 135



# Dead straight.

**Hardened steel, clear etched markings** and **ISO9001 certification** - the **Sterling range of stainless steel rulers** deliver accurate measurements and straight edges.



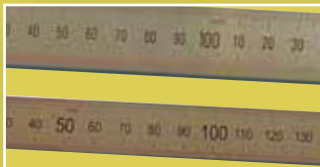

**Hardened  
stainless steel**



**All markings etched  
in for durability**

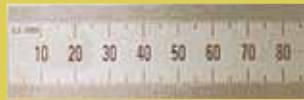

**ISO9001 certified  
manufacturer  
assures accuracy**

## Stainless Steel Rulers



| CODE          | DESCRIPTION   | BOX QTY | CTN QTY |
|---------------|---|---------|---------|
| <b>1521</b>   | 150mm/6in Stainless Steel Ruler - Metric/Imperial   | 10      | 500     |
| <b>3021</b>   | 300mm/12in Stainless Steel Ruler - Metric/Imperial  | 10      | 250     |
| <b>3021-M</b> | 300mm Stainless Steel Ruler - Metric Only           | 10      | 250     |
| <b>4521</b>   | 450mm/18in Stainless Steel Ruler - Metric/Imperial  | 10      | 100     |
| <b>6021</b>   | 600mm/24in Stainless Steel Ruler - Metric/Imperial  | 10      | 100     |
| <b>6021-M</b> | 600mm Stainless Steel Ruler - Metric Only           | 10      | 100     |
| <b>10021</b>  | 1000mm/40in Stainless Steel Ruler - Metric/Imperial | 10      | 60      |
| <b>15021</b>  | 1500mm/60in Stainless Steel Ruler - Metric/Imperial | 10      | 30      |
| <b>20021</b>  | 2000mm/80in Stainless Steel Ruler - Metric/Imperial | 10      | 10      |

- Hardened Stainless Steel rules
- Metric/imperial markings and metric only markings available
- ISO9001 certified manufacturer assures accuracy
- All markings are etched into the Stainless Steel for durability
- Metric only rules have conversion chart on back

**Sterling**<sup>®</sup>

# RULERS 137

**RULERS**



## Aluminum Rulers - Straight Edges

| CODE           | DESCRIPTION   | BOX QTY | CTN QTY |
|----------------|---------------|---------|---------|
| <b>6021-A</b>  | 600mm Metric  | 6       | 30      |
| <b>12021-A</b> | 1200mm Metric | 6       | 24      |
| <b>15021-A</b> | 1500mm Metric | 6       | 6       |
| <b>20021-A</b> | 2000mm Metric | 6       | 6       |

- Industrial quality aluminum rules with finger recess
- Markings printed directly onto rule for durability
- Strong sturdy construction – will not bend

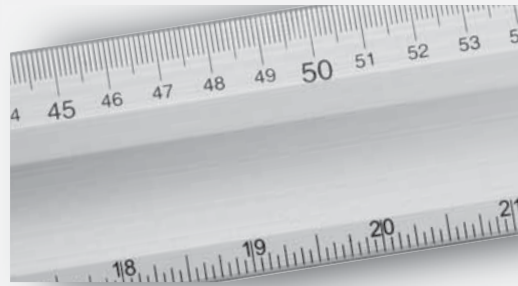

## Aluminum Rulers with Rubber Back

| CODE            | DESCRIPTION   | BOX QTY | CTN QTY |
|-----------------|---------------|---------|---------|
| <b>6021-AR</b>  | 600mm Metric  | 1       | 30      |
| <b>12021-AR</b> | 1200mm Metric | 1       | 24      |
| <b>15021-AR</b> | 1500mm Metric | 1       | 6       |
| <b>20021-AR</b> | 2000mm Metric | 1       | 6       |

- Industrial quality aluminum rules with finger recess
- Markings printed directly onto rule for durability
- Strong sturdy construction – will not bend
- Supplied with non-slip rubber back
- Ideal for signwriting industry

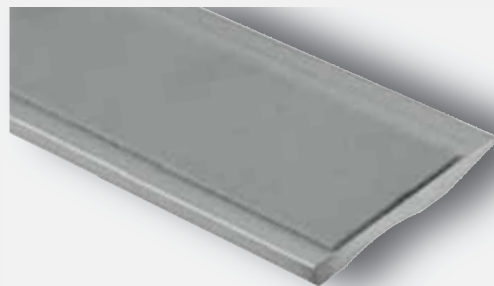

**COMBS52**  
Metric

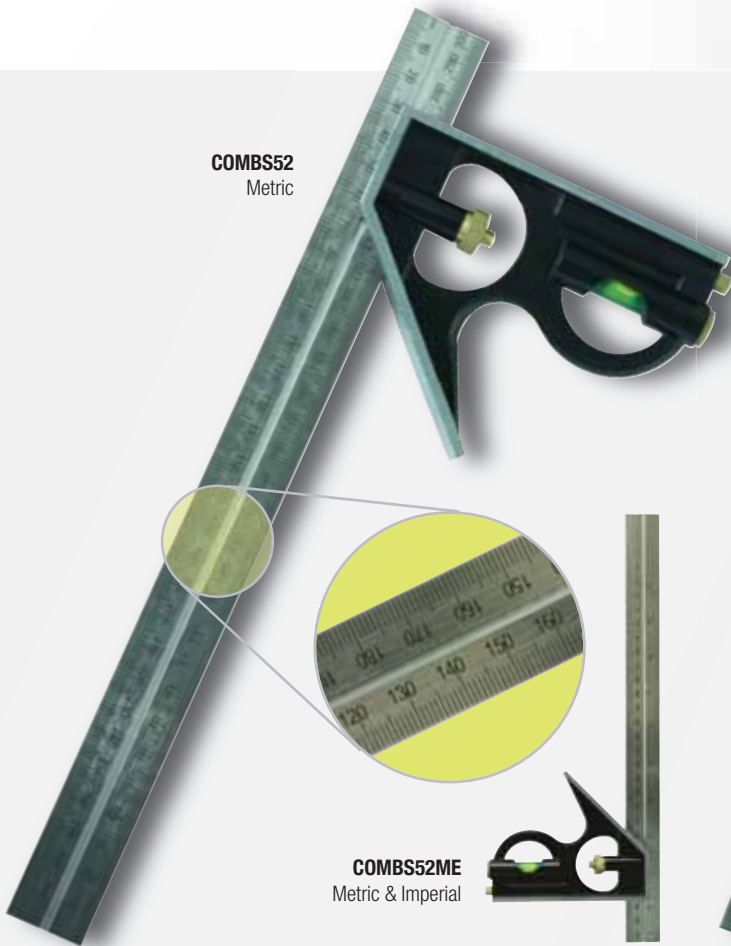

**COMBS52ME**  
Metric & Imperial



**COMBS53**  
Metric



**COMBS53ME**  
Metric & Imperial



# COMBS52 Standard Combination Square

## COMBINATION SET SQUARE NO.52

| CODE             | DESCRIPTION                                     | BOX QTY | CTN QTY |
|------------------|---|---------|---------|
| <b>COMBS52</b>   | Combination Square No.52 <i>Metric</i>          | 1       | 40      |
| <b>COMBS52ME</b> | Combination Square No.52 <i>Metric/Imperial</i> | 1       | 40      |

- Multi purpose gauge
- Strong and accurate
- Stainless steel blade with etched markings for durability
- Sturdy aluminum headstock
- Machined faces and Locking Spring ensure accuracy and precision adjustment
- Inbuilt Scriber

Carded



# COMBS53 Heavy Duty Combination Square

## HEAVY DUTY COMBINATION SET SQUARE NO.53

| CODE             | DESCRIPTION                                     | BOX QTY | CTN QTY |
|------------------|---|---------|---------|
| <b>COMBS53</b>   | Combination Square No.53 <i>Metric</i>          | 1       | 40      |
| <b>COMBS53ME</b> | Combination Square No.53 <i>Metric/Imperial</i> | 1       | 40      |

- Strong and accurate
- Stainless steel blade with etched markings for durability
- Heavy duty cast iron headstock
- Machined faces and Locking Spring ensure accuracy and precision adjustment
- Inbuilt Scriber

Carded



A close-up, high-contrast photograph of an elephant's skin, showing deep wrinkles and folds. The lighting is dramatic, highlighting the texture of the skin. The text 'Size it up!' is overlaid on the left side of the image.

# Size it up!

**Endurance taken to the limit!** Sterling's **Enduro tape** is manufactured from **stainless steel components**, with a **high wear, water resistant nylon coating** on a strong **stainless steel blade**, complete with a **three rivet end hook**.

All tapes are manufactured to ISO Accredited Standards.



Strong 25mm wide blade



All parts Stainless Steel



Suitable for wet conditions

Enduro Tape



25mm Wide Tape

**Sterling**

**ENDURO STAINLESS STEEL TAPE MEASURE**

| CODE            | DESCRIPTION                    | BOX QTY | CTN QTY |
|-----------------|--------------------------------|---------|---------|
| <b>END8025</b>  | 8.9m x 25mm Metric             | 6       | 24      |
| <b>END8025I</b> | 8m/27ft x 25mm Metric/Imperial | 6       | 24      |

- Nylon Coated Stainless Steel blade
- All metal Parts are Stainless Steel
- Suitable for use in wet conditions
- Packed in convenient Countertop display



Carded



**END8025I** Metric & Imperial Tape



Display x 6pcs

tapes 141

**Sterling**

MEASURING TAPES



## Sterling TBC Professional

### PROFESSIONAL RUBBER GRIP TAPE MEASURE - 5M/8M/10M

| CODE            | DESCRIPTION              | BOX QTY | CTN QTY |
|-----------------|--------------------------|---------|---------|
| <b>TBC5019</b>  | 5mx19mm Metric           | 24      | 72      |
| <b>TBC5019I</b> | 5m/16ftx19mm Metric/Imp  | 24      | 72      |
| <b>TBC8025</b>  | 8mx25mm Metric           | 18      | 36      |
| <b>TBC8025I</b> | 8m/27ftx25mm Metric/Imp  | 18      | 36      |
| <b>TBC1025</b>  | 10m/25mm Metric          | 18      | 36      |
| <b>TBC1025I</b> | 10m/33ftx25mm Metric/Imp | 18      | 36      |

- 4 rivet end hook for extra strength on 8m & 10m tapes
- Double nylon coated matte finish blade for abrasion resistance
- Rubber sides and grip for comfortable use
- Extra thick blade material for superior life
- Fully graduated millimetre markings on 8m and 10m to limit 100mm syndrome
- Thickened true zero end hook to maintain accuracy
- Each tape supplied with hanging card for display



Display box



Magnetic End

## Sterling TBCM Professional Magnetic

### PROFESSIONAL MAGNETIC HOOK TAPE MEASURE - 8M/10M

| CODE             | DESCRIPTION              | BOX QTY | CTN QTY |
|------------------|--------------------------|---------|---------|
| <b>TBCM8025</b>  | 8mx25mm Metric           | 18      | 36      |
| <b>TBCM8025I</b> | 8m/27ftx25mm Metric/Imp  | 18      | 36      |
| <b>TBCM1025</b>  | 10mx25mm Metric          | 18      | 36      |
| <b>TBCM1025I</b> | 10m/33ftx25mm Metric/Imp | 18      | 36      |

- Magnetic end hook with 4 rivets ideal for steel construction industry
- Double nylon coated matte finish blade for abrasion resistance
- Rubber sides and grip for comfortable use
- Extra thick blade material for superior life
- Fully graduated millimetre markings to limit 100mm syndrome
- Thickened true zero end hook to maintain accuracy
- Each tape supplied with hanging card for display



Display box x18pcs



27mm Wide Tape

Magnet and rubber cover

## Sterling KingGrip Rubber Case

### KINGGRIP CHROME/RUBBER TAPE MEASURE

| CODE            | DESCRIPTION                    | BOX QTY | CTN QTY |
|-----------------|--------------------------------|---------|---------|
| <b>KGM8027</b>  | 8m x 27mm Metric               | 18      | 36      |
| <b>KGM8027I</b> | 8m/27ft x 27mm Metric/Imperial | 18      | 36      |

- Strong 27mm wide blade
- 2.6m blade stand out
- 4 rivet strong magnetic end hook with non-marking rubber cover – grips or attaches with ease
- Extra tough chrome case with rubber grip
- High wear resistant nylon coated blade



Display box x18pcs

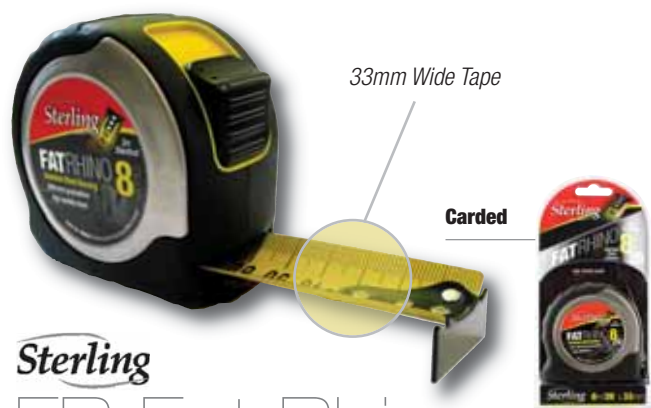

Sterling

## FR Fat Rhino

## FAT RHINO WIDE BLADE TAPE MEASURE

| CODE           | DESCRIPTION             | BOX QTY | CTN QTY |
|----------------|-------------------------|---------|---------|
| <b>FR8033</b>  | 8mx33mm Metric Carded   | 6       | 24      |
| <b>FR8033I</b> | 8m/27ftx33mm Metric/Imp | 6       | 24      |

- 33mm wide blade provides rigidity and extra long 3M standout
- Heavy duty Stainless Steel Case with rubber grip
- 6 rivet hook for extra holding strength



Sterling

TC Dual-Plus  
Double-Stop

## 10M DUAL-PLUS DOUBLE-STOP TAPE MEASURE

| CODE           | DESCRIPTION                | BOX QTY | CTN QTY |
|----------------|----------------------------|---------|---------|
| <b>TC1025</b>  | 10mx25mm Metric            | 18      | 36      |
| <b>TC1025I</b> | 10m/33ftx25mm Metric/Imp   | 18      | 36      |
| <b>TCM1025</b> | 10mx25mm Metric – Magnetic | 18      | 36      |

- Professional tape measure
- Heavy duty double-stop - pauser under tape
- Double nylon coated matte finish blade for abrasion resistance
- Strong 4 rivet gripper end hook for extra strength
- Each tape supplied with hanging card for display

TMT Tru-Grip



Sterling

## TRU-GRIP - TAPE MEASURE

| CODE            | DESCRIPTION                    | BOX QTY | CTN QTY |
|-----------------|--------------------------------|---------|---------|
| <b>TMT3516</b>  | 3.5mx16mm Metric               | 36      | 72      |
| <b>TMT3516I</b> | 3.5m/12ftx16mm Metric/Imperial | 36      | 72      |
| <b>TMT5019</b>  | 5mx19mm Metric                 | 24      | 72      |
| <b>TMT5019I</b> | 5m/16ftx19mm Metric/Imperial   | 24      | 72      |
| <b>TMT8025</b>  | 8mx25mm Metric                 | 18      | 36      |
| <b>TMT8025I</b> | 8m/27ftx25mm Metric/Imperial   | 18      | 36      |

- Compact tape with rubber grip
- Double nylon coated matte finish blade for abrasion resistance
- 4 rivet hook for extra strength on 8m tapes
- True zero hook for accuracy

Display box



V-Force Fluoro



**V-FORCE MEASURING TAPE FLOURO - 8M**

| CODE           | DESCRIPTION                      | BOX QTY | CTN QTY |
|----------------|----------------------------------|---------|---------|
| <b>V8025F</b>  | 8m x 25mm Metric Fluoro          | 12      | 24      |
| <b>V8025IF</b> | 8m/27ft x 25mm Metric/Imp Fluoro | 12      | 24      |

- Compact design for easier handling
- 3x Hi-Vis colours for easy location in a toolbox
- Clear graduated millimeter markings
- Attractive counter display of 12pcs - 4x Pink, 4x Orange, 4x Green

Display box x12pcs



**Sterling V-Force**

**V-FORCE MEASURING TAPE - 8M**

| CODE          | DESCRIPTION               | BOX QTY | CTN QTY |
|---------------|---------------------------|---------|---------|
| <b>V8025</b>  | 8m x 25mm Metric          | 12      | 24      |
| <b>V8025I</b> | 8m/27ft x 25mm Metric/Imp | 12      | 24      |

- Compact design for easier handling
- Hi-Vis Yellow to locate quicker in a toolbox
- Clear graduated millimeter markings
- Attractive counter display of 12



Display box x12pcs



**Sterling e Rubber**

**RUBBER GRIP TAPE MEASURE - 8M**

| CODE        | DESCRIPTION                           | BOX QTY | CTN QTY |
|-------------|---------------------------------------|---------|---------|
| <b>846</b>  | 8m x 25mm Metric White Blade          | 10      | 40      |
| <b>846I</b> | 8m/27ft x 25mm Metric/Imp White Blade | 10      | 40      |

- White blade with clear easy to read markings
- Rubber grip case
- 3 rivet hook for strength



Display box x10pcs



Tape Tech



Carded



**STERLING E TAPE MEASURE RANGE**

| CODE         | DESCRIPTION                | BOX QTY | CTN QTY |
|--------------|----------------------------|---------|---------|
| <b>289</b>   | 2m x 16mm Metric           | 10      | 200     |
| <b>389</b>   | 3m x 16mm Metric           | 10      | 40      |
| <b>385I</b>  | 3m/10ft x 16mm Metric/Imp  | 10      | 60      |
| <b>589</b>   | 5m x 19mm Metric           | 10      | 40      |
| <b>589I</b>  | 5m/16ft x 19mm Metric/Imp  | 10      | 40      |
| <b>889</b>   | 8m x 25mm Metric           | 10      | 40      |
| <b>889I</b>  | 8m/26ft x 25mm Metric/Imp  | 10      | 40      |
| <b>1089</b>  | 10m x 25mm Metric          | 10      | 40      |
| <b>1089I</b> | 10m/33ft x 25mm Metric/Imp | 10      | 40      |

- Rubber back case
- Metric or metric/imperial markings
- 3 rivet end hook
- The most consistently accurate value tape measure range

Display box x10pcs

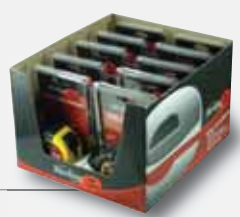

**Sterling®**  
TLR Professional

**PROFESSIONAL STEEL CLOSED REEL TAPE**

| CODE            | DESCRIPTION                         | BOX QTY | CTN QTY |
|-----------------|-------------------------------------|---------|---------|
| <b>TLR2095</b>  | 20m x 9.5mm Metric Carded           | 5       | 10      |
| <b>TLR3095</b>  | 30m x 9.5mm Metric Carded           | 5       | 10      |
| <b>TLR3095I</b> | 30m/100ft x 9.5mm Metric/Imp Carded | 5       | 10      |

- 10mm abrasion resistant nylon coated steel blade
- Rubber grip impact resistant case
- Belt clip on back
- Claw & loop end hook for any job
- Easy winder in side for fast retraction

Carded



**Sterling®**  
EG3013 Fibreglass

**30M FIBREGLASS CLOSED REEL TAPE MEASURE**

| CODE          | DESCRIPTION             | BOX QTY | CTN QTY |
|---------------|-------------------------|---------|---------|
| <b>EG3013</b> | 30m x 13mm Metric Boxed | 1       | 20      |

- High quality reinforced fibreglass tape with clasp-style end hook
- Closed reel layflat style
- Suitable for surveying use

## NK 3x Speed Winder



### SPEED-WINDER STEEL TAPE

| CODE           | DESCRIPTION                | BOX QTY | CTN QTY |
|----------------|----------------------------|---------|---------|
| <b>NK3010</b>  | 30m x 10mm Metric - Steel  | 1       | 10      |
| <b>NK5010</b>  | 50m x 10mm Metric - Steel  | 1       | 10      |
| <b>NK10010</b> | 100m x 10mm Metric - Steel | 1       | 10      |

- Open reel geared 3x speed return saves time rewinding tape
- High quality 10mm nylon coated steel tape
- Suitable for surveying, building, fencing, etc



Carded



## Sterling NR Steel

### STEEL OPEN REEL TAPE – NR SERIES

| CODE           | DESCRIPTION        | BOX QTY | CTN QTY |
|----------------|--------------------|---------|---------|
| <b>NR3010</b>  | 30m x 10mm Metric  | 1       | 10      |
| <b>NR5010</b>  | 50m x 10mm Metric  | 1       | 10      |
| <b>NR10010</b> | 100m x 10mm Metric | 1       | 10      |

- Open reel casing
- High quality 10mm nylon coated steel blade
- Suitable for surveying, building, fencing, etc



## B3013 Fibreglass

### FIBREGLASS CLOSED REEL TAPE

| CODE         | DESCRIPTION                       | BOX QTY | CTN QTY |
|--------------|-----------------------------------|---------|---------|
| <b>B3013</b> | 30m/100ft x 13mm Metric/Imp Boxed | 1       | 60      |

- Closed reel fibreglass lay flat tape
- Strong ABS case
- 13mm wide reinforced fibreglass tape



Sterling

## OF Fibreglass

## FIBREGLASS OPEN REEL TAPE

| CODE           | DESCRIPTION        | BOX QTY | CTN QTY |
|----------------|--------------------|---------|---------|
| <b>OF3013</b>  | 30m x 13mm Metric  | 1       | 20      |
| <b>OF5013</b>  | 50m x 13mm Metric  | 1       | 10      |
| <b>OF10013</b> | 100m x 13mm Metric | 1       | 10      |

- Open reel casing
- High quality 13mm fibreglass lay flat tape
- Suitable for surveying use
- Strong ABS case with rubber grip



Sterling

## NP Series

## FIBREGLASS OPEN REEL TAPE

| CODE           | DESCRIPTION                        | BOX QTY | CTN QTY |
|----------------|------------------------------------|---------|---------|
| <b>NP1513</b>  | 15m/50ft x 13mm Metric/Imp Boxed   | 5       | 20      |
| <b>NP3013</b>  | 30m/100ft x 13mm Metric/Imp Boxed  | 5       | 20      |
| <b>NP5013</b>  | 50m/165ft x 13mm Metric/Imp Boxed  | 5       | 10      |
| <b>NP10013</b> | 100m/330ft x 13mm Metric/Imp Boxed | 5       | 10      |

- Open reel fibreglass lay flat tape
- 13mm reinforced tape
- Sturdy plastic case with reinforced winding mechanism

## XBA Fat Blade



Sterling

## FATBLADE 3X SPEED-WINDER FIBREGLASS TAPE

| CODE           | DESCRIPTION       | BOX QTY | CTN QTY |
|----------------|-------------------|---------|---------|
| <b>XBA3020</b> | 30m x 20mm Metric | 1       | 10      |
| <b>XBA5020</b> | 50m x 20mm Metric | 1       | 10      |

- 20mm extra wide reinforced fibreglass tape
- Strong compact ABS casing with rubber grip handle
- Geared 3x speed winder mechanism saves rewinding time
- Strong reinforced end hook with magnetic loop & true zero claw
- Super strong reinforced hook connection to tape ideal for mining



Carded

## ALC3013 Y-Liner



Comes with survey peg in handle



### Y-LINER

| CODE           | DESCRIPTION            | BOX QTY | CTN QTY |
|----------------|------------------------|---------|---------|
| <b>ALC3013</b> | 30m x 13mm Steel Boxed | 1       | 10      |
| <b>ALC5013</b> | 50m x 13mm Steel Boxed | 1       | 10      |

- Extra sturdy steel body for construction & mining applications
- Contoured handle for easy use
- Nylon coated steel blade for durability
- Comes with survey peg handle
- Multifunction end hook to suit all applications

## MW12 Wheelwalker



### FOLDING MEASURING WHEEL

| CODE        | DESCRIPTION                   | BOX QTY | CTN QTY |
|-------------|-------------------------------|---------|---------|
| <b>MW12</b> | Folding Measuring Wheel Boxed | 1       | 4       |

- Records up to 9999M
- 2 counter reset buttons for easy continual use
- 318mm diameter rubber grip wheel
- Zero point indicator for accurate measuring
- 120cm length folds down to 60cm
- Trigger brake prevents 'free wheeling'
- Net weight 2.05kg
- Supplied with carry bag

Carry bag



## MW06 Mini Wheelwalker



### MINI WHEELWALKER

| CODE        | DESCRIPTION            | BOX QTY | CTN QTY |
|-------------|------------------------|---------|---------|
| <b>MW06</b> | Mini Wheelwalker Boxed | 1       | 6       |

- Records up to 9999.9M
- Small lightweight (1.1kg) wheelwalker ideal for quoting and professional users
- 160mm diameter rubber grip wheel
- Stem folds down from 102cm to 43cm
- Accurate measurement with zero point indicator
- Braking trigger prevents 'free wheeling' and allows multiple measurements
- Press button counter reset
- Supplied with carry bag

Carry bag



## LFP Pistol Grip

### PISTOL GRIP STEEL OPEN REEL TAPE

| CODE            | DESCRIPTION                  | BOX QTY | CTN QTY |
|-----------------|------------------------------|---------|---------|
| <b>LFP3013I</b> | 30m/100ft x 13mm Pistol Grip | 5       | 10      |
| <b>LFP5013I</b> | 50m/165ft x 13mm Pistol Grip | 5       | 10      |

- Pistol grip style open reel tape
- Strong 13mm wide steel tape
- High quality adrasion resistant nylon coated steel blade
- Claw & loop end hook for ease of use

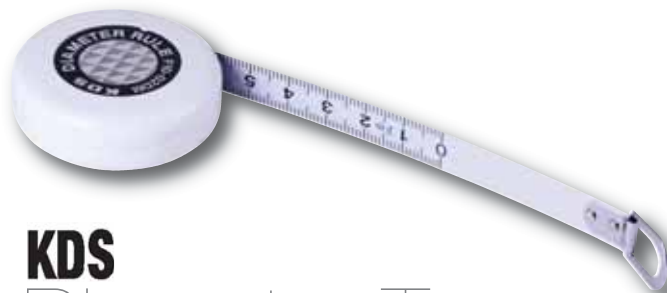

## KDS

## Diameter Tape

### 2M KDS DIAMETER TAPE MEASURE

| CODE            | DESCRIPTION              | BOX QTY | CTN QTY |
|-----------------|--------------------------|---------|---------|
| <b>F10-02DM</b> | 2M Diameter Tape Measure | 10      | 100     |

- Metric &  $\pi$  measurements for circumference and diameter measuring
- Durable nylon coated steel blade to ensure markings won't wear
- Compact, handy design ideal for logging & pipework
- Flat tape measures around curves



## KDS DVZ Dual Measurement

### DUAL MEASUREMENT DURA-COAT MEASURING TAPE

| CODE           | DESCRIPTION | BOX QTY | CTN QTY |
|----------------|-------------|---------|---------|
| <b>DVZ1935</b> | 3.5m x 19mm | 12      | 24      |
| <b>DVZ1950</b> | 5.0m x 19mm | 12      | 24      |
| <b>DVZ2575</b> | 7.5m x 25mm | 12      | 24      |

- Dual measurement markings top & bottom of blade
- Full metric top side Metric/Imperial under side
- Dura-Coat coated blade to eliminate markings wearing
- JIS Class 1 Accuracy Standard
- Diamond 5 rivet end hook with grippers



Display Box of 12pcs



Carded



## KDS GES G-Edition

### G-EDITION CLASS 1 - 8M

| CODE              | DESCRIPTION               | BOX QTY | CTN QTY |
|-------------------|---------------------------|---------|---------|
| <b>GES25-80MM</b> | 8m x 25mm Metric          | 10      | 20      |
| <b>GES25-80ME</b> | 8m/27ft x 25mm Metric/Imp | 10      | 20      |

- JIS Class 1 Measurement - the most accurate standard
- Diamond 5 rivet end hook with grippers
- White Blade with clear graduated millimetre markings
- Extremely durable blade markings to resist wear
- Rubber case protects end hook to maintain accuracy
- Fully incremented markings prevents '100mm' error



## KDS MN25-02

### KDS MINI ROD 2M

| CODE           | DESCRIPTION  | BOX QTY | CTN QTY |
|----------------|--------------|---------|---------|
| <b>MN25-02</b> | Yellow Boxed | 10      | 50      |

- 2M tape with two sided markings. Normal Metric on one side and Rod markings on the other
- Rod markings are ideal for survey work and photo records.



## KDS KLI020ME

### KDS 20M ENCLOSED CASE STEEL TAPE

| CODE            | DESCRIPTION      | BOX QTY | CTN QTY |
|-----------------|------------------|---------|---------|
| <b>KLI020ME</b> | Dark Grey Carded | 6       | 36      |

- Nylon coated long steel tape with Class 1 accuracy
- Sturdy ABS case with vinyl wrist strap
- Metric / Imperial markings



## KDS TL Tecron

### TECRON COATED STEEL OPEN REEL TAPE

| CODE             | DESCRIPTION      | BOX QTY | CTN QTY |
|------------------|------------------|---------|---------|
| <b>TL10-30DH</b> | 30m x 10mm Boxed | 1       | 5       |
| <b>TL10-50DH</b> | 50m x 10mm Boxed | 1       | 5       |

- Highest quality nylon coated steel tape
- JIS Class 1 certified accuracy
- Made in Japan
- Tough case with rubber grip handle
- Claw & loop style end hook



## KDS SST 4x Speed-Winder

### STAINLESS STEEL TAPE

| CODE              | DESCRIPTION      | BOX QTY | CTN QTY |
|-------------------|------------------|---------|---------|
| <b>SST10-30DH</b> | 30m x 10mm Boxed | 1       | 5       |
| <b>SST10-50DH</b> | 50m x 10mm Boxed | 1       | 5       |

- 4x Super Speed Winder
- Highest quality 10mm Tecron coated Stainless Steel tape
- JIS Class 1 certified accuracy
- Made in Japan
- Rubber grip handle
- Claw & loop style end hook



RIGHT READ - LEFT TO RIGHT >>>>



LEFT READ - RIGHT TO LEFT <<<<

## KDS Setting Measure

### ADHESIVE BENCH SETTING MEASURES

| CODE              | DESCRIPTION                   | BOX QTY | CTN QTY |
|-------------------|-------------------------------|---------|---------|
| <b>ST13-01BP</b>  | 1m Bench Tape (left to right) | 10      | 100     |
| <b>ST13-02BP</b>  | 2m Bench Tape (left to right) | 10      | 100     |
| <b>ST13-05BP</b>  | 5m Bench Tape (left to right) | 10      | 100     |
| <b>STB13-01BP</b> | 1m Bench Tape (right to left) | 10      | 100     |
| <b>STB13-02BP</b> | 2m Bench Tape (right to left) | 10      | 100     |
| <b>STB13-05BP</b> | 5m Bench Tape (right to left) | 10      | 100     |

- Stick-on flat rule suitable for benches, set out rods, machining, etc
- Can be cut to desired length
- JIS Class 1 certified accuracy
- Available printed Right-to-Left and Left-to-Right

Carded



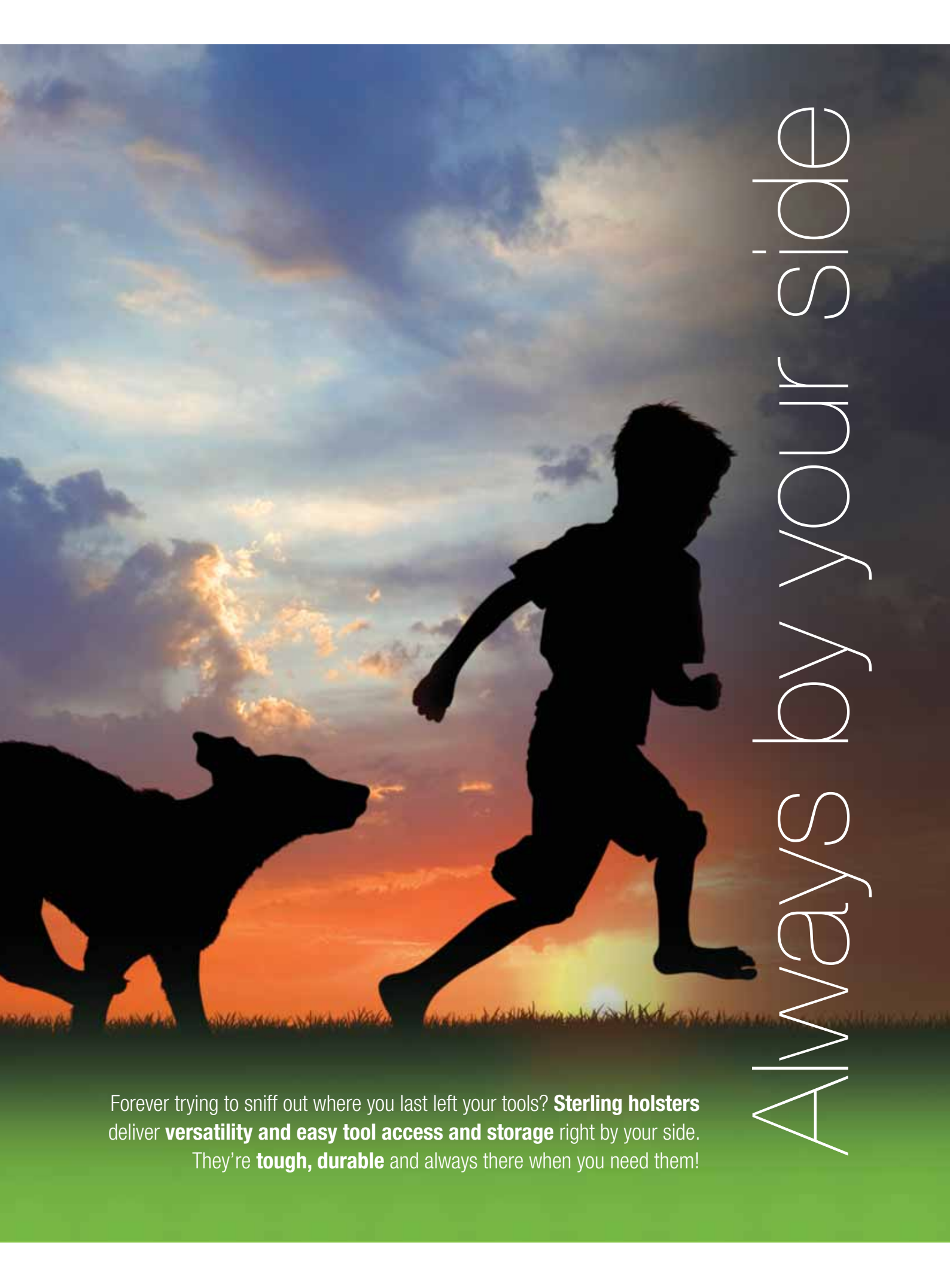

Always by your side

Forever trying to sniff out where you last left your tools? **Sterling holsters** deliver **versatility and easy tool access and storage** right by your side. They're **tough, durable** and always there when you need them!





Tough durable nylon material



Lanyard hole to keep tools attached



Suits a wide range of Sterling tools

# STC65 Nylon Holster



## HOLSTER – NYLON

| CODE         | DESCRIPTION   | BOX QTY | CTN QTY |
|--------------|---------------|---------|---------|
| <b>STC65</b> | Nylon Holster | 1       | 120     |

- Tough durable nylon material
- Easy tool access
- Lanyard hole to keep tools attached
- Suits a wide range of Sterling tools including Black Panther Snips and Autoloading Knives



# holsters 153

HOLSTERS

*Sterling*<sup>®</sup>

## HOLST-ST

### STERLING KNIFE & BLADE HOLSTER

| CODE            | DESCRIPTION | BOX QTY | CTN QTY |
|-----------------|-------------|---------|---------|
| <b>HOLST-ST</b> | Black Bulk  | 6       | 120     |

- Safely and conveniently holds a knife on your belt ready to use
- Velcro lid holds knife in place when not in use
- Extra pocket for replacement blades
- Pen holder down side of holster



*Sterling*<sup>®</sup>

## HOLST-B

### HOLSTER - PLASTIC

| CODE           | DESCRIPTION  | BOX QTY | CTN QTY |
|----------------|--------------|---------|---------|
| <b>HOLST-B</b> | Bulk - Black | 1       | 1       |

- Black plastic holster suits #105 Shark Knife, smaller knives and scissors



*Sterling*<sup>®</sup>

## HOLST-C

### CANVAS KNIFE & BLADE HOLDER

| CODE           | DESCRIPTION | BOX QTY | CTN QTY |
|----------------|-------------|---------|---------|
| <b>HOLST-C</b> | Black Bulk  | 6       | 120     |

- Safely and conveniently holds knife on your belt ready to use
- Pocket with Velcro strip holds spare blade packets
- Pen holder down side of holster



*Sterling*<sup>®</sup>

## HOLST-Y

### HOLSTER - PLASTIC

| CODE           | DESCRIPTION | BOX QTY | CTN QTY |
|----------------|-------------|---------|---------|
| <b>HOLST-Y</b> | Bulk Yellow | 1       | 1       |

- Yellow plastic holster to suit larger knives



## Sterling® Tool Bag



### CARRY-ALL TOOL BAG

| CODE         | DESCRIPTION   | BOX QTY | CTN QTY |
|--------------|---------------|---------|---------|
| <b>TOOLB</b> | Canvas - Bulk | 1       | 20      |

- Durable canvas carry-all design
- Ideal for holding all your hand tools

## Sterling® TPC-135

### MULTI-PURPOSE LEATHER POUCH

| CODE           | DESCRIPTION  | BOX QTY | CTN QTY |
|----------------|--------------|---------|---------|
| <b>TPC-135</b> | Leather Bulk | 1       | 42      |

- Heavy duty multi-riveted construction
- Suits knives, snips and scissors
- Takes multiple tools in one holster



## Sterling® STC45 Knife Holster

### HOLSTER - LEATHER

| CODE         | DESCRIPTION    | BOX QTY | CTN QTY |
|--------------|----------------|---------|---------|
| <b>STC45</b> | Leather - Bulk | 1       | 120     |

- Suits retractable knives and large snap off cutters
- Features durable construction, extra riveted strap around top
- Left and right handed use



## Sterling® BTC35 Boot Knife

### HOLSTER - LEATHER

| CODE         | DESCRIPTION    | BOX QTY | CTN QTY |
|--------------|----------------|---------|---------|
| <b>BTC35</b> | Leather - Bulk | 1       | 120     |

- Suits boot knives 802 or 803. *See pg. 55*
- Features thick durable construction



# Anchored Fast

Need to anchor it down fast? **Sterling staplers and staples** deliver **solid, strong stapling solutions**. Their versatile and durable range of products are perfect for **upholstering, decorating, tacking, framing and commercial & household tacking jobs**.



Durable aluminium die-cast body



Ergonomic bi-material handle - reduces fatigue



Supplied with 300 staples



# Python Multi-Function Staple Gun



**Sterling®**

## MULTI-FUNCTION STAPLE GUN

| CODE          | DESCRIPTION                         | BOX QTY | CTN QTY |
|---------------|-------------------------------------|---------|---------|
| <b>AT-901</b> | Sterling Multi- Function Staple Gun | 6       | 24      |

- Heavy duty, trade quality aluminium die-cast body
- Power adjustment control system
- Ergonomic bi-material handle - reduces fatigue
- Low staple refill window – Easy bottom loading of staples
- Supplied with 300 staples
- Safety handle lock
- Hanging blister packaging

### Applications

- Poster tacking & framing
- Upholstering & decorating
- Carpet & upholstery
- Insulation
- Commercial & household tacking jobs

### Staples

- Flat wire staples 6 - 14mm
- Sterling A11
- Arrow T50
- Rapid 140 Series
- 18 gauge brad nails (16mm / 5/8")

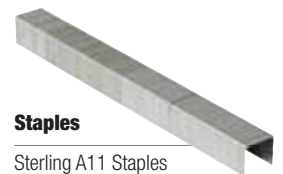

### Staples

Sterling A11 Staples  
See pgs. 164-165



### Plastic Boxes

2000/5000 Box

**Sterling®**

# Staplers 157

STAPLERS & STAPLES

## FHT-910 Hammer Tacker



### HAMMER TACKER

| CODE           | DESCRIPTION            | BOX QTY | CTN QTY |
|----------------|------------------------|---------|---------|
| <b>FHT-910</b> | Sterling Hammer Tacker | 10      | -       |

- Heavy duty construction
- Compact metal design
- Single handed operation
- Ergonomic rubber grip handle
- Hanging blister packaging
- Rear loading magazine for larger capacity

#### Applications:

- Heavy duty insulation
- Plastic, carpet laying
- Sheeting & roofing
- General carpentry

#### Staples:

- Flat wire staples 6 - 14mm
- Sterling A11
- Arrow T50
- Rapid 140 Series staples



## AH-915 Heavy Duty Hammer Tacker



### HEAVY DUTY HAMMER TACKER

| CODE          | DESCRIPTION                       | BOX QTY | CTN QTY |
|---------------|-----------------------------------|---------|---------|
| <b>AH-915</b> | Sterling Heavy Duty Hammer Tacker | 10      | -       |

- Heavy duty construction
- Compact metal design with hardened steel parts
- Single handed operation
- Ergonomic rubber grip handle
- Face protection guard ensures staples finish flush with workface
- Easy bottom loading of staples
- Hanging blister packaging

#### Applications:

- Heavy duty insulation
- Plastic, carpet laying
- Sheeting & roofing
- General carpentry

#### Staples:

- Flat wire staples 6 - 14mm
- Sterling A11
- Arrow T50
- Rapid 140 Series staples



AT-765B Heavy  
Duty Staple Gun

Sterling®

**HEAVY DUTY STAPLE GUN**

| CODE           | DESCRIPTION                    | BOX QTY | CTN QTY |
|----------------|--------------------------------|---------|---------|
| <b>AT-765B</b> | Sterling Heavy Duty Staple Gun | 6       | 24      |

- Nickel plated finish to resist corrosion
- Durable all-steel construction
- Heavy duty – trade quality
- Anti-slip rubber grip handle
- Easy bottom loading of staples
- Hanging blister packaging

**Applications:**

- Poster tacking & framing
- Upholstering & decorating
- Carpet & upholstery
- insulation
- Commercial & household tacking jobs

**Staples:**

- Flat wire staples 6 - 14mm
- Sterling A11
- Arrow T50
- Rapid 140 Series
- Takes 18 gauge brad nails (16mm / 5/8")

**Staples**

Sterling A11 Staples  
See pgs. 164-165

**Plastic Boxes**

2000/ 5000

AT-516  
3-Way Staple Gun

Sterling®

**3-WAY STAPLE GUN**

| CODE          | DESCRIPTION               | BOX QTY | CTN QTY |
|---------------|---------------------------|---------|---------|
| <b>AT-516</b> | Sterling 3-Way Staple Gun | 6       | 24      |

- High impact moulded plastic housing
- Power adjustment control system
- Durable metal staple magazine
- Low staple refill window
- Easy bottom loading of staples
- Hanging blister packaging

**Applications:**

- Stationery, packaging & industrial
- Tacking, framing, upholstery
- Carpet laying, insulation

**Staples:**

- Fine wire staples 6 - 14mm
- Sterling 13 Series
- Arrow JT-21
- Rapid 13 & 53 Series
- Takes 18 gauge brad nails (16mm / 5/8")

**Staples**

13 Series Staples  
See pg. 167

**Boxed**

5000

## AT-911 3-Way Staple Gun



### 3-WAY STAPLE GUN

| CODE          | DESCRIPTION               | BOX QTY | CTN QTY |
|---------------|---------------------------|---------|---------|
| <b>AT-911</b> | Sterling 3-Way Staple Gun | 6       | 24      |

- Durable aluminium die-cast housing
- Durable metal magazine
- Comfortable & ergonomic bi-material handle
- Easy bottom loading magazine
- Safety handle lock
- Hanging blister packaging

#### Applications:

- Ideal for plastics, leather, fabrics etc
- Stationery, packaging & industrial
- Tacking, framing, upholstery
- Carpet laying, insulation

#### Staples:

- Fine wire staples 4 - 10mm
- Sterling 13 Series Staples
- Rapid 13 & 53 Series
- Takes 18 gauge brad nails (10mm / 3/8")

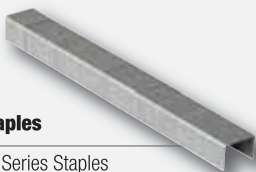

**Staples**

13 Series Staples  
See pg. 167



**Boxed** 13 Series Staples

## AT-916 3-Way Staple Gun



### HEAVY DUTY 3-WAY STAPLE GUN

| CODE          | DESCRIPTION               | BOX QTY | CTN QTY |
|---------------|---------------------------|---------|---------|
| <b>AT-916</b> | Sterling 3-Way Staple Gun | 6       | 24      |

- Durable aluminium die-cast housing
- Durable metal magazine
- Comfortable and ergonomic bi-material handle
- Power adjustment control system
- Easy bottom loading magazine
- Low staple refill window
- Hanging blister packaging

#### Applications:

- Ideal for plastics, leather, fabrics etc
- Stationery, packaging & industrial
- Tacking, framing, upholstery
- Carpet laying, insulation

#### Staples:

- Fine wire staples 6 - 16mm
- Sterling 13 Series
- Rapid 13 & 53 Series
- Takes 18 gauge brad nails (16mm / 5/8")



**Staples**

13 Series Staples  
See pg. 167



**Boxed** 13 Series Staples



AT-961  
Cable Tacker

Sterling®

**CABLE TACKER**

| CODE          | DESCRIPTION           | BOX QTY | CTN QTY |
|---------------|-----------------------|---------|---------|
| <b>AT-961</b> | Sterling Cable Tacker | 6       | 24      |

- Professional heavy duty cable tacker
- Durable die-cast construction
- Durable metal magazine
- Easy bottom loading mechanism
- Low staple refill window
- Safety handle lock

**Applications:**

- For securing low voltage cables and wires (<50V)
- Max wire diameter 4.8mm ( 3/16")

**Staples:**

- Cable staples 9 - 11mm
- Sterling 6110 cable staples
- Rapid #28 cable staples
- Arrow T-18 cable staples

**Staples**

6110 Cable Staples

**Boxed**

1000

AT-962  
Cable Tacker

Sterling®

**CABLE TACKER**

| CODE          | DESCRIPTION           | BOX QTY | CTN QTY |
|---------------|-----------------------|---------|---------|
| <b>AT-962</b> | Sterling Cable Tacker | 6       | 24      |

- Professional heavy duty cable tacker
- Durable die-cast construction
- Durable metal magazine
- Easy bottom loading mechanism
- Low staple refill window
- Safety handle lock
- Hanging blister packaging

**Applications:**

- For securing low voltage cables and wires (<50V)
- Max wire diameter 6.4mm ( 1/4")

**Staples:**

- Cable staples 10 - 14mm
- Sterling 6212 cable staples
- Rapid #36 cable staples
- Arrow T-25 cable staples

**Staples**

6212 Cable Staples

**Boxed**

1000



# AT-301 Handy Tacker



**Sterling®**

## HANDY TACKER

| CODE   | DESCRIPTION           | BOX QTY | CTN QTY |
|--------|-----------------------|---------|---------|
| AT-301 | Sterling Handy Tacker | 6       | 24      |

- Durable hi-impact ABS housing
- Safety handle lock
- Easy bottom loading magazine
- Staple refill window
- Hanging blister packaging

### Applications:

- Upholstering
- Picture framing, poster tacking
- Ideal for DIY work

### Staples:

- Fine wire staples 6 - 12mm
- Takes Sterling 26 Series staples

### Staples

26 Series Staples  
See pg. 167

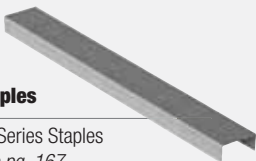

### Boxed

5000



# AP-250 Plier Type Stapler



**Sterling®**

## PLIER TYPE STAPLER

| CODE   | DESCRIPTION                 | BOX QTY | CTN QTY |
|--------|-----------------------------|---------|---------|
| AP-250 | Sterling Plier Type Stapler | 10      | -       |

- High quality all-purpose plier type stapler
- Heavy duty metal construction
- Staples up to 40 sheets of paper

### Applications:

- Wrapping paper
- Fabrics, price tags
- Fastening bags
- Home and office stapling jobs

### Staples:

- Fine wire staples 6 - 8mm
- Takes Sterling 26 Series staples

### Staples

26 Series Staples  
See pg. 167



### Boxed

5000



# AP-270 Multi-Function Heavy Duty Plier Type Stapler



**Sterling®**

## MULTI-FUNCTION HEAVY DUTY PLIER TYPE STAPLER

| CODE          | DESCRIPTION                                | BOX QTY | CTN QTY |
|---------------|--|---------|---------|
| <b>AP-270</b> | Sterling Multi-Function Plier Type Stapler | 10      | -       |

- High quality all-purpose plier type stapler
- Heavy duty metal construction
- Supplied with 2 attachments – bag anvil and sword anvil

### Applications:

- Wrapping paper
- Fabrics, price tags
- Fastening bags
- Home and office stapling jobs

### Staples:

- Fine wire staples 6 - 12mm
- Takes Sterling 73 Series staples



### Staples

Sterling 73 Series Staples  
See pg. 168

# AR-425 Staple Remover



**Sterling®**

## STAPLE REMOVER

| CODE          | DESCRIPTION             | BOX QTY | CTN QTY |
|---------------|-------------------------|---------|---------|
| <b>AR-425</b> | Sterling Staple remover | 10      | 100     |

- Robust steel construction
- Ergonomic comfortable handle
- Designed to remove thick and long heavy duty staples

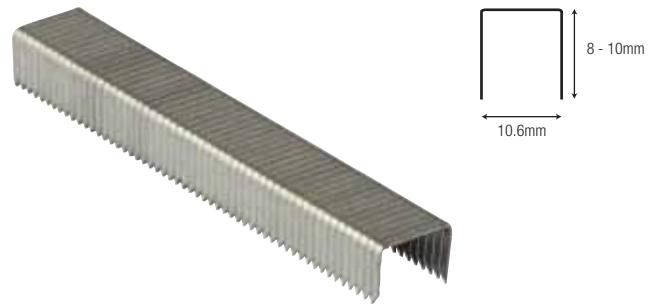
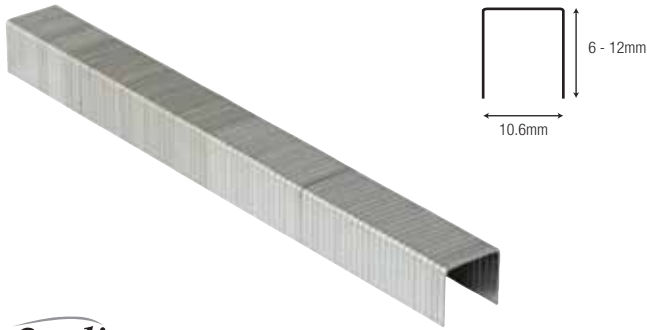

## Sterling® A11 / 140 Series: (Standard)

### A11 SERIES STAPLES - STANDARD FLAT WIRE

| CODE            | DESCRIPTION                                | BOX QTY | CTN QTY |
|-----------------|--|---------|---------|
| <b>A1106-2M</b> | 6mm A11 Series Staples - plastic box 2000  | 1       | 40      |
| <b>A1106-5M</b> | 6mm A11 Series Staples - plastic box 5000  | 1       | 20      |
| <b>A1108-2M</b> | 8mm A11 Series Staples - plastic box 2000  | 1       | 40      |
| <b>A1108-5M</b> | 8mm A11 Series Staples - plastic box 5000  | 1       | 20      |
| <b>A1110-2M</b> | 10mm A11 Series Staples - plastic box 2000 | 1       | 40      |
| <b>A1110-5M</b> | 10mm A11 Series Staples - plastic box 5000 | 1       | 20      |
| <b>A1112-2M</b> | 12mm A11 Series Staples - plastic box 2000 | 1       | 40      |
| <b>A1112-5M</b> | 12mm A11 Series Staples - plastic box 5000 | 1       | 20      |

Wire Size: 0.45 x 1.25mm

- Strong flat wire style
- Electro galvanised
- Chisel point
- Packed in a unique reusable plastic box\*

#### Applications:

- Framing & upholstery
- Carpet installation, insulation and plastering
- Commercial and household tacking jobs

#### Suits:

- Sterling AT-901, AT-765B, FHT-910, AH-915. See pgs. 157-159.
- Rapid 14, 34, 44
- Arrow T50, T55, HT 50
- Interchangeable with Rapid 140, Arrow T50

## Sterling® A11 / 140 Series Sharp Point

### A11 SERIES STAPLES - SHARP POINT FLAT WIRE

| CODE              | DESCRIPTION  | BOX QTY | CTN QTY |
|-------------------|--|---------|---------|
| <b>A1108-2MSP</b> | 8mm A11 Series Sharp Point Staples - plastic box 2000  | 1       | 40      |
| <b>A1108-5MSP</b> | 8mm A11 Series Sharp Point Staples - plastic box 5000  | 1       | 20      |
| <b>A1110-2MSP</b> | 10mm A11 Series Sharp Point Staples - plastic box 2000 | 1       | 40      |
| <b>A1110-5MSP</b> | 10mm A11 Series Sharp Point Staples - plastic box 5000 | 1       | 20      |

Wire Size: 0.45 x 1.25mm

- Strong flat wire style
- Electro galvanised
- Divergent point for better penetration and holding in plaster, etc
- Packed in a unique reusable plastic box\*

#### Applications:

- Carpet installation, insulation and plastering

#### Suits:

- Sterling AT-901, AT-765B, FHT-910, AH-915 See pgs. 157-159.
- Rapid 14, 34, 44
- Arrow T50, T55, HT 50
- Interchangeable with Rapid 140, Arrow T50

Boxed

2000



Boxed

5000



Boxed

2000



Boxed

5000



\*Colour of plastic box may vary from colour shown

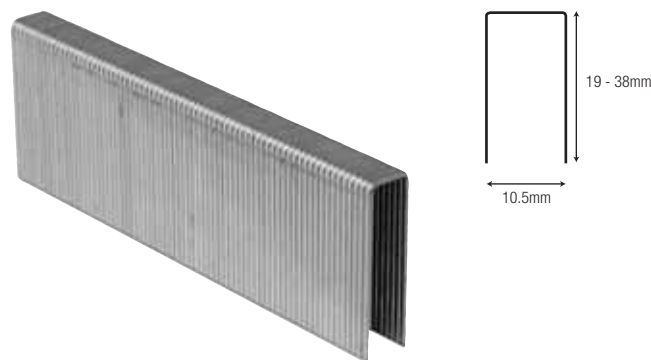
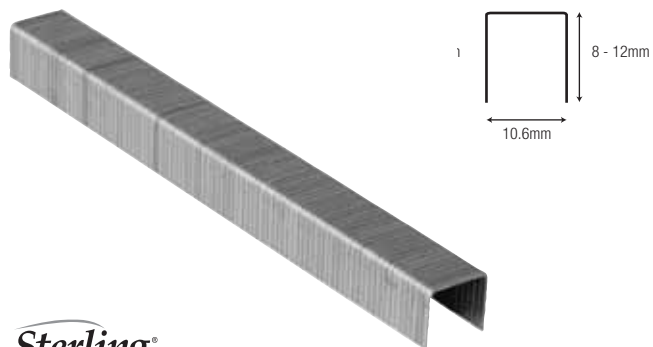

## Sterling® A11 / 140 Series Stainless Steel

### A11 SERIES STAPLES - STAINLESS STEEL FLAT WIRE

| CODE              | DESCRIPTION  | BOX QTY | CTN QTY |
|-------------------|--|---------|---------|
| <b>A1108-2MSS</b> | 8mm A11 Series S/Steel Staples - plastic box 2000  | 1       | 40      |
| <b>A1108-5MSS</b> | 8mm A11 Series S/Steel Staples - plastic box 5000  | 1       | 20      |
| <b>A1110-2MSS</b> | 10mm A11 Series S/Steel Staples - plastic box 2000 | 1       | 40      |
| <b>A1110-5MSS</b> | 10mm A11 Series S/Steel Staples - plastic box 5000 | 1       | 20      |
| <b>A1112-2MSS</b> | 12mm A11 Series S/Steel Staples - plastic box 2000 | 1       | 40      |
| <b>A1112-5MSS</b> | 12mm A11 Series S/Steel Staples - plastic box 5000 | 1       | 20      |

Wire Size: 0.45 x 1.25mm

- Strong flat wire style
- 304 grade stainless steel
- Chisel point
- Packed in a unique reusable plastic box\*

#### Applications:

- Framing & upholstery
- Carpet installation, insulation and plastering
- Commercial and household tacking jobs
- For use in outdoor and coastal environments

#### Suits:

- Sterling AT-901, AT-765B, FHT-910, AH-915. See pgs. 157-159.
- Rapid 14, 34, 44
- Arrow T50, T55, HT 50
- Interchangeable with Rapid 140, Arrow T50

Boxed

2000



Boxed

5000



## Sterling® G5562 Series

### G5562 SERIES STAPLES HEAVY WIRE

| CODE              | DESCRIPTION                            | BOX QTY | CTN QTY |
|-------------------|--|---------|---------|
| <b>AG5519-10M</b> | 19mm G5562 Series Staples - box 10,000 | 1       | -       |
| <b>AG5525-10M</b> | 25mm G5562 Series Staples - box 10,000 | 1       | -       |
| <b>AG5535-10M</b> | 35mm G5562 Series Staples - box 10,000 | 1       | -       |
| <b>AG5538-10M</b> | 38mm G5562 Series Staples - box 10,000 | 1       | -       |

Wire Size: 1.40 x 1.60mm (16 gauge)

- Strong heavy wire style
- Electro galvanised
- Chisel point
- Bulk carton of 10,000

#### Applications:

- Bedding frames & furniture
- Window manufacture

#### Suits:

- 5562 Series air and electric staplers

Carton





## Sterling® 6000 Series

### 6000 SERIES STAPLES MEDIUM WIRE

| CODE            | DESCRIPTION                                 | BOX QTY | CTN QTY |
|-----------------|---|---------|---------|
| <b>A6016-5M</b> | 16mm 6000 Series Staples - plastic box 5000 | 1       | 20      |
| <b>A6018-5M</b> | 18mm 6000 Series Staples - plastic box 5000 | 1       | 20      |
| <b>A6020-5M</b> | 20mm 6000 Series Staples - plastic box 5000 | 1       | 20      |
| <b>A6022-5M</b> | 22mm 6000 Series Staples - plastic box 5000 | 1       | 20      |
| <b>A6025-5M</b> | 25mm 6000 Series Staples - plastic box 5000 | 1       | 10      |
| <b>A6032-5M</b> | 32mm 6000 Series Staples - plastic box 5000 | 1       | 10      |
| <b>A6038-5M</b> | 38mm 6000 Series Staples - plastic box 5000 | 1       | 10      |

Wire Size: 1.00 x 1.25mm (18 gauge)

- Strong medium wire style
- Electro galvanised
- Chisel point
- Packed in a unique reusable plastic box\*

#### Applications:

- Flooring & underlay
- Cabinet & kitchen manufacture
- Furniture frames

#### Suits:

- 6000 Series air and electric staplers



Plastic Boxes

5000

\*Colour of plastic box may vary from colour shown

## Sterling® 4000 Series

### 4000 SERIES STAPLES FINE WIRE

| CODE            | DESCRIPTION                                 | BOX QTY | CTN QTY |
|-----------------|---|---------|---------|
| <b>A4012-5M</b> | 12mm 4000 Series Staples - plastic box 5000 | 1       | 40      |
| <b>A4014-5M</b> | 14mm 4000 Series Staples - plastic box 5000 | 1       | 40      |
| <b>A4016-5M</b> | 16mm 4000 Series Staples - plastic box 5000 | 1       | 20      |
| <b>A4018-5M</b> | 18mm 4000 Series Staples - plastic box 5000 | 1       | 20      |
| <b>A4020-5M</b> | 20mm 4000 Series Staples - plastic box 5000 | 1       | 20      |
| <b>A4022-5M</b> | 22mm 4000 Series Staples - plastic box 5000 | 1       | 20      |

Wire Size: 0.65 x 0.95mm (21 gauge)

- Strong flat wire style
- Electro galvanised
- Chisel point
- Packed in a unique reusable plastic box\*

#### Applications:

- Cabinet & kitchen manufacture
- Picture framing
- Carpet laying

#### Suits:

- 4000 Series air and electric tackers



Boxed

5000 - 12mm



Boxed

5000 - 14-22mm

\*Colour of plastic box may vary from colour shown

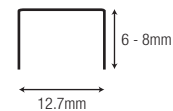
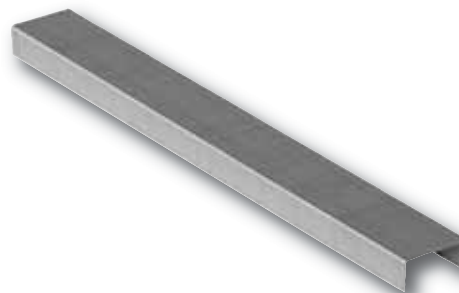
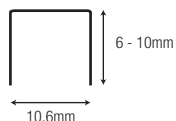

## Sterling® 13 Series

### 13 SERIES STAPLES FINE WIRE

| CODE            | DESCRIPTION                       | BOX QTY | CTN QTY |
|-----------------|-----------------------------------|---------|---------|
| <b>A1306-5M</b> | 6mm 13 Series Staples - box 5000  | 1       | -       |
| <b>A1308-5M</b> | 8mm 13 Series Staples - box 5000  | 1       | -       |
| <b>A1310-5M</b> | 10mm 13 Series Staples - box 5000 | 1       | -       |

Wire Size: 0.75 x 0.52mm

- Fine wire style
- Electro Galvanised
- Chisel Point
- Box of 5000

#### Applications:

- Furniture and box construction
- Home and office staplers

#### Suits:

- Sterling AT-516 See pg. 159, AT-911, AT-916, See pg. 160
- Interchangeable with
  - Rapid #13 & #53 Series staples,
  - Arrow JT21 staples

Boxed

5000



## Sterling® 26 Series

### 26 SERIES STAPLES FINE WIRE

| CODE            | DESCRIPTION                      | BOX QTY | CTN QTY |
|-----------------|----------------------------------|---------|---------|
| <b>A2606-5M</b> | 6mm 26 Series Staples - box 5000 | 1       | -       |
| <b>A2608-5M</b> | 8mm 26 Series Staples - box 5000 | 1       | -       |

Wire Size: 0.50 x 0.40mm

- Fine wire style staples
- Electro galvanised
- Chisel point
- Box of 5000

#### Applications:

- Light duty picture framing & upholstery
- Office stapling

#### Suits:

- Sterling AP-240, AT-301
- All 26 series office staplers

Boxed

5000



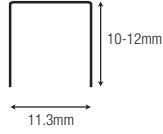

## Sterling® 73 Series Staples

### 73 SERIES STAPLES FINE WIRE

| CODE                                       | DESCRIPTION                               | BOX QTY | CTN QTY |
|--|---|---------|---------|
| <b>A7310-5M</b>                            | 10mm 73 Series Staples - plastic box 5000 | 1       | 20      |
| <b>A7312-5M</b>                            | 12mm 73 Series Staples - plastic box 5000 | 1       | 20      |
| <i>Wire Size: 1.25 x 0.52mm (20 gauge)</i> |   |         |         |

- Strong fine wire staples
- Electro galvanised
- Chisel point
- Box of 5000

#### Applications:

- Stapling fabric & price tags
- Fastening bags, wrapping paper etc

#### Suits:

- Sterling AP-270. *See pg. 163.*

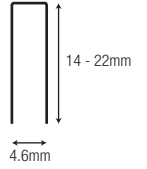
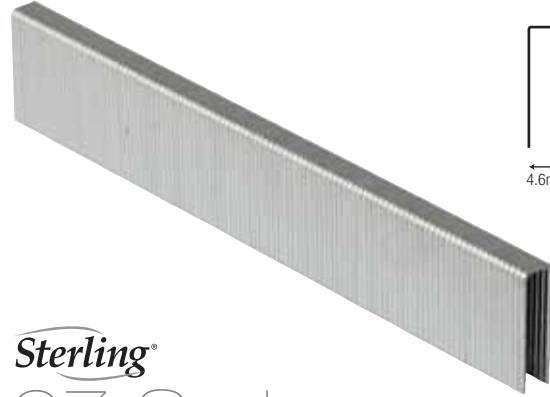

## Sterling® 97 Series Staples

### 97 SERIES STAPLES FINE WIRE

| CODE                            | DESCRIPTION                               | BOX QTY | CTN QTY |
|---------------------------------|---|---------|---------|
| <b>A9714-5M</b>                 | 14mm 97 Series Staples - plastic box 5000 | 1       | 40      |
| <b>A9716-5M</b>                 | 16mm 97 Series Staples - plastic box 5000 | 1       | 40      |
| <b>A9718-5M</b>                 | 18mm 97 Series Staples - plastic box 5000 | 1       | 20      |
| <b>A9722-5M</b>                 | 22mm 97 Series Staples - plastic box 5000 | 1       | 20      |
| <i>Wire Size: 0.91 x 0.70mm</i> |   |         |         |

- Strong fine wire style
- Electro galvanised
- Chisel Point
- Plastic box of 5000\*

#### Applications:

- Cabinet & kitchen manufacture
- Picture framing
- Carpet laying

#### Suits:

- 97 Series air and electric staplers



#### Plastic Boxes

\* Colour of plastic box may vary from colour shown



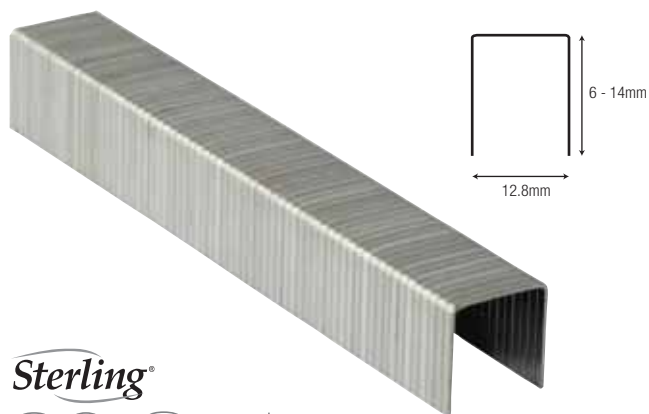

## Sterling® 80 Series

### 80 SERIES STAPLES FINE WIRE

| CODE               | DESCRIPTION   | BOX QTY | CTN QTY |
|--------------------|---|---------|---------|
| <b>A8060-10MPB</b> | 6mm (1/4") 80 Series Staples - <i>plastic box</i>   | 10,000  | 1 20    |
| <b>A8080-10MPB</b> | 8mm (5/16") 80 Series Staples - <i>plastic box</i>  | 10,000  | 1 20    |
| <b>A8010-10MPB</b> | 10mm (3/8") 80 Series Staples - <i>plastic box</i>  | 10,000  | 1 20    |
| <b>A8010-5MPB</b>  | 10mm (3/8") 80 Series Staples - <i>plastic box</i>  | 5000    | 1 10    |
| <b>A8012-5MPB</b>  | 12mm (1/2") 80 Series Staples - <i>plastic box</i>  | 5000    | 1 10    |
| <b>A8014-5MPB</b>  | 14mm (9/16") 80 Series Staples - <i>plastic box</i> | 5000    | 1 10    |
| <b>A8060-10M</b>   | 6mm (1/4") 80 Series Staples - <i>bulk box</i>      | 10,000  | 1 20    |
| <b>A8080-10M</b>   | 8mm (5/16") 80 Series Staples - <i>bulk box</i>     | 10,000  | 1 20    |
| <b>A8010-10M</b>   | 10mm (3/8") 80 Series Staples - <i>bulk box</i>     | 10,000  | 1 20    |
| <b>A8012-5M</b>    | 12mm (1/2") 80 Series Staples - <i>bulk box</i>     | 5000    | 1 20    |
| <b>A8014-5M</b>    | 14mm (9/16") 80 Series Staples - <i>bulk box</i>    | 5000    | 1 20    |

Wire Size: 0.95 x 0.65mm

- Fine wire style
- Electro galvanised
- Chisel point
- Available in either plastic\* or cardboard boxes

#### Applications:

- Cupboard backing & furniture manufacture
- House wrapping
- Labelling
- Mattress bases
- Picture framing
- Upholstery
- Craft work

#### Suits:

- All 80 Series air and electric staplers

#### Boxed

Cardboard x5000



#### Plastic Boxes

Plastic x5000

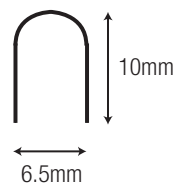

## Sterling® Cable Staples

### CABLE STAPLES

| CODE           | DESCRIPTION                          | BOX QTY | CTN QTY |
|----------------|--------------------------------------|---------|---------|
| <b>A6110-M</b> | 10mm (3/8") Cable Staples - Box 1000 | 1       | -       |

Wire Size: 1.20 x 0.60mm

- Chisel point
- Electro galvanised

#### Applications:

- Low voltage cables up to 4.8mm diameter

#### Suits:

- Sterling AT-961. *See pg. 161.*
- Interchangeable with Rapid 36, Arrow T-18

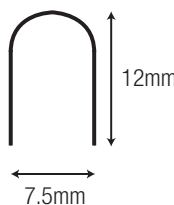

## Sterling® Cable Staples

### CABLE STAPLES

| CODE           | DESCRIPTION                          | BOX QTY | CTN QTY |
|----------------|--------------------------------------|---------|---------|
| <b>A6212-M</b> | 12mm (1/2") Cable Staples - Box 1000 | 1       | -       |

Wire Size: 1.20 x 0.60mm

- Chisel point
- Electro galvanised

#### Applications:

- Low voltage cables up to 6.4mm diameter

#### Suits:

- Sterling AT-962. *See pg. 161.*
- Interchangeable with Rapid 36, Arrow T-25



**Sterling Supercut hacksaw blades** are just that - supercutting! The **variable tooth blades** cut **30% faster** than traditional blades, with the **bi-metal flexible and shatterproof qualities** delivering exceptional durability.

Systematic attack!

**ULTRASu**

Variable tooth geometry cuts 30% faster

BI-METAL STEEL FLEXIBLE  
VARIABLE TOOTH

Bi-Metal flexible blade

**Sterling**

Shatterproof highest grade industrial quality



# Ultra Supercut



## ULTRA SUPERCUT VARIABLE TOOTH HACKSAW BLADES

| CODE            | DESCRIPTION | PACK QTY | BOX QTY |
|-----------------|-------------|----------|---------|
| <b>300-VARU</b> | 20-24 TPI   | 10*      | 100     |

- Variable Tooth Geometry 20 / 24 TPI
- Cuts 30% faster - The new generation hacksaw blade
- Bi-Metal Flexible Blade 12" / 300mm
- Shatterproof highest grade industrial quality
- Suits hacksaw frames HF-40T and HF-506 - See pg. 63



# hacksaw 171

**HACKSAW BLADES**

## Sterling Ultra



### STERLING ULTRA HACKSAW BLADES

| CODE           | DESCRIPTION | PACK QTY | BOX QTY |
|----------------|-------------|----------|---------|
| <b>300-18U</b> | 18TPI       | 10*      | 100     |
| <b>300-24U</b> | 24TPI       | 10*      | 100     |
| <b>300-32U</b> | 32TPI       | 10*      | 100     |

\* Pack quantities only

- Bi-Metal with 8% Cobalt for extreme performance
- Lasts up to 30% longer than standard Bi-Metal
- Shatterproof high grade industrial quality blade 12"/300mm
- Suits hacksaw frames HF-40T and HF-506. *See pg. 63*



## Sterling Bi-Metal



### BI-METAL HACKSAW BLADES

| CODE           | DESCRIPTION | PACK QTY | BOX QTY |
|----------------|-------------|----------|---------|
| <b>300-18S</b> | 18TPI       | 10*      | 100     |
| <b>300-24S</b> | 24TPI       | 10*      | 100     |
| <b>300-32S</b> | 32TPI       | 10*      | 100     |

\* Pack quantities only

- Bi-Metal flexible blade 12" / 300mm
- Virtually unbreakable
- Industrial quality
- Suits hacksaw frames HF-40T and HF-506. *See pg. 63*



## Alpha Carbody

**AIR HACKSAW BLADES**

| CODE           | DESCRIPTION        | BOX QTY | CTN QTY |
|----------------|--------------------|---------|---------|
| <b>CBB-14A</b> | 14tpi – Pack of 10 | 1       | 200     |
| <b>CBB-18A</b> | 18tpi – Pack of 10 | 1       | 200     |
| <b>CBB-24A</b> | 24tpi – Pack of 10 | 1       | 200     |
| <b>CBB-32A</b> | 32tpi – Pack of 10 | 1       | 200     |

- Car Body Blades
- Bi-Metal
- 14, 18, 24, 32 TPI available
- Supplied in Plastic 10 pack case

## MPS Carbody

**MPS****PREMIUM AIR HACKSAW BLADES**

| CODE             | DESCRIPTION       | BOX QTY | CTN QTY |
|------------------|-------------------|---------|---------|
| <b>CBB-18MPS</b> | 18tpi – Pack of 5 | 1       |         |
| <b>CBB-24MPS</b> | 24tpi – Pack of 5 | 1       |         |
| <b>CBB-32MPS</b> | 32tpi – Pack of 5 | 1       |         |

- Premium grade Car Body Blades
- 8% Cobalt for extreme performance
- Shatterproof Bi-Metal material
- Made in Germany

Made from high Carbon alloy steel precision ground and sharpened to a razor edge, Sterling 921 Heavy Duty blades provide maximum sharpness and durability.

Holds the edge



Most popular universal trimming blade



Made from high Carbon alloy



Sharpened to a razor edge for max sharpness and durability



#### 921-2D DISPENSER

The 921-2D 100 blade dispenser includes a helpful dispensing arm for safer blade presentation



921 Heavy Duty



*Sterling*<sup>®</sup>

#### 921 - HEAVY DUTY TRIMMING KNIFE BLADE

| CODE          | DESCRIPTION                        | BOX QTY | CTN QTY |
|---------------|------------------------------------|---------|---------|
| <b>921-2</b>  | Box of 100                         | 1       | 44      |
| <b>921-2D</b> | Dispenser of 100                   | 1       | 20      |
| <b>921-3</b>  | Pack of 5                          | 20*     | 2000    |
| <b>921-4D</b> | Dispenser of 10                    | 10*     | 10      |
| <b>921-1</b>  | Card of 5                          | 20*     | 20      |
| <b>921-TD</b> | <b>Tungsten</b> – Dispenser of 100 | 1       | 20      |

\*Box quantities only      Dimensions    L 60mm    W 18.8mm    T 0.63mm

- Made in Sheffield - England
- Most popular universal trimming blade
- Sterling blades are made from High Carbon alloy steel precision ground and sharpened to a razor edge that provides maximum sharpness and durability
- Tungsten blade also available for high wear resistance



**921-2D** 100 blade dispenser



**921-4D** 10 blade dispenser



**921-3** 5 blades carded

*Sterling*

trimming

175

TRIMMING BLADES

## 928 Safety Tip

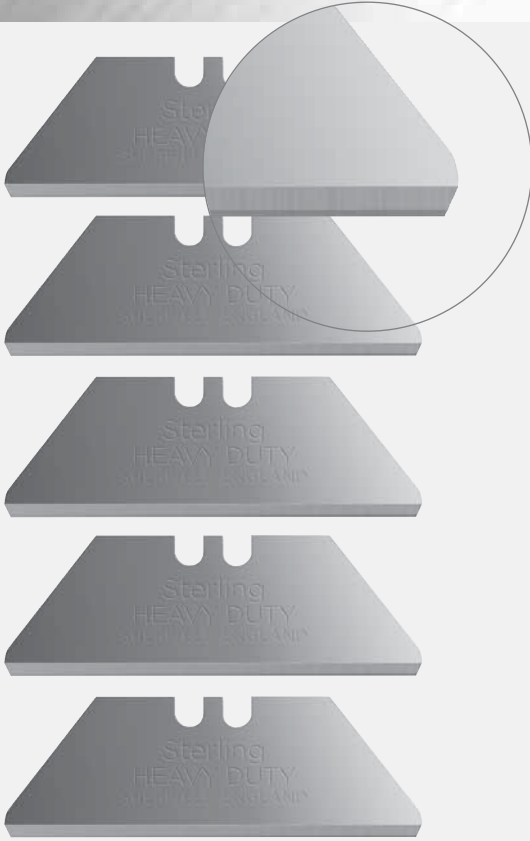

### 928 HEAVY DUTY SAFETY TIP TRIMMING KNIFE BLADE

| CODE          | DESCRIPTION      | BOX QTY | CTN QTY |
|---------------|------------------|---------|---------|
| <b>928-2</b>  | Box of 100       | 1       | 125     |
| <b>928-2D</b> | Dispenser of 100 | 1       | 50      |
| <b>928-3</b>  | Pack of 5        | 20*     | 600     |
| <b>928-4D</b> | Dispenser of 10  | 10*     | 10      |

\*Box quantities only

| Dimensions | L 50mm | W 18.8mm | T 0.65mm |
|------------|--------|----------|----------|
|------------|--------|----------|----------|

- Rounded tips for safety - no sharp points
- Prevents damage to carton contents
- Made in Sheffield - England
- Ideal for packaging and increased safety
- Will fit most trimming knives



**928-2D** 100 blade dispenser



**928-4D** 10 blade dispenser



## FLOOR DOT Heavy Duty Blade

| CODE           | DESCRIPTION | BOX QTY | CTN QTY           |
|----------------|-------------|---------|-------------------|
| <b>04-3003</b> | Box of 100  | 10      | 100               |
| Dimensions     |             | L 60mm  | W 18.8mm T 0.63mm |

- Premium quality
- Triple ground heavy duty blades for the flooring industry
- Suits most trimming knives



## Sterling<sup>e</sup> Heavy Duty Tradeblade

| CODE         | DESCRIPTION            | BOX QTY | CTN QTY           |
|--------------|------------------------|---------|-------------------|
| <b>26100</b> | Dispenser of 100       | 1       | 30                |
| <b>26010</b> | Dispenser of 10 Carded | 10      | 300               |
| <b>26005</b> | Card of 5              | 20      | 500               |
| Dimensions   |                        | L 60mm  | W 18.8mm T 0.63mm |

- Made in UK
- Suits most trimming knives
- Ideal for Drywall Industry



## Sterling<sup>®</sup> 03-018 Extra Heavy Duty

### EXTRA HEAVY DUTY TRIMMING KNIFE BLADE

| CODE          | DESCRIPTION | BOX QTY | CTN QTY           |
|---------------|-------------|---------|-------------------|
| <b>03-018</b> | Box of 100  | 1       | 30                |
| Dimensions    |             | L 60mm  | W 18.8mm T 0.90mm |

- Extra thick (0.9mm) Stainless Steel
- Made in Sheffield - England
- Ideal for demanding applications where a strong, rigid blade is required
- Extremely break resistant
- Suits most trimming knives





Sterling

177

Sterling®

## 922 Centre Hole

### 922 - HEAVY DUTY TRIMMING KNIFE BLADE WITH CENTRE HOLE

| CODE                 | DESCRIPTION | BOX QTY    | CTN QTY                  |
|----------------------|-------------|------------|--------------------------|
| <b>922-3</b>         | Pack of 5   | 20*        | 2000                     |
| *Box quantities only |             | Dimensions | L 60mm W 18.8mm T 0.63mm |

- With centre hole to suit special tool holders
- Made in Sheffield - England



Sterling®

## 9210 Three Notch

### HEAVY DUTY TRIMMING KNIFE BLADE WITH 3 NOTCHES

| CODE                 | DESCRIPTION | BOX QTY    | CTN QTY                    |
|----------------------|-------------|------------|----------------------------|
| <b>9210-3</b>        | Pack of 5   | 20*        | 2000                       |
| *Box quantities only |             | Dimensions | L 52.6mm W 18.8mm T 0.63mm |

- With three notches
- Suits SRK-B6 knife - See pg. 44, SSK knife - See pg. 46 and some other knives and scrapers
- Made in Sheffield - England



Sterling®

## KBS5 Three Notch Round Point

### THREE NOTCH ROUND POINT KNIFE BLADE

| CODE        | DESCRIPTION                    | BOX QTY  | CTN QTY           |
|-------------|--------------------------------|----------|-------------------|
| <b>KBS5</b> | Three Notch Round Point Blades | 10       | 2000              |
| Dimensions  |                                | L 52.6mm | W 18.8mm T 0.63mm |

- Rounded point Safety blade with 3 notches
- Suits SRK-B6 knife - See pg. 44, SSK knife - See pg. 46 and some other knives & scrapers
- Made in USA

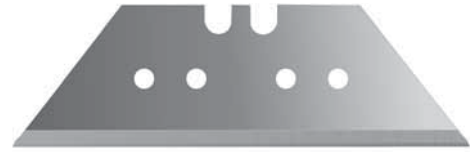

Sterling®

## 924 Four Hole

### 924 - HEAVY DUTY TRIMMING KNIFE BLADE

| CODE                 | DESCRIPTION               | BOX QTY    | CTN QTY                  |
|----------------------|---------------------------|------------|--------------------------|
| <b>924-3</b>         | Pack of 5                 | 20*        | 2000                     |
| <b>924-4D</b>        | Dispenser of 10           | 10*        | 10                       |
| <b>924-3S</b>        | Pack of 5 Stainless Steel | 20         | 1000                     |
| *Box quantities only |                           | Dimensions | L 60mm W 18.8mm T 0.63mm |

- With four holes
- Suits some German utility knives and machine applications
- Made in Sheffield - England
- Stainless Steel blades also available



**924-4D** 10 blade dispenser



Sterling®

## 926 Multifit

### HEAVY DUTY TRIMMING KNIFE BLADE - MULTIFIT

| CODE                 | DESCRIPTION     | BOX QTY    | CTN QTY                    |
|----------------------|-----------------|------------|----------------------------|
| <b>926-3</b>         | Pack of 5       | 20*        | 2000                       |
| <b>926-4D</b>        | Dispenser at 10 | 10         | 10                         |
| *Box quantities only |                 | Dimensions | L 52.6mm W 18.8mm T 0.63mm |

- Multifit - 3 notches, 4 holes and centre hole
- Suits a range of German safety and utility knives
- Made in Sheffield - England

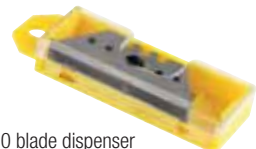

**926-4D** 10 blade dispenser

## 911 Standard Duty

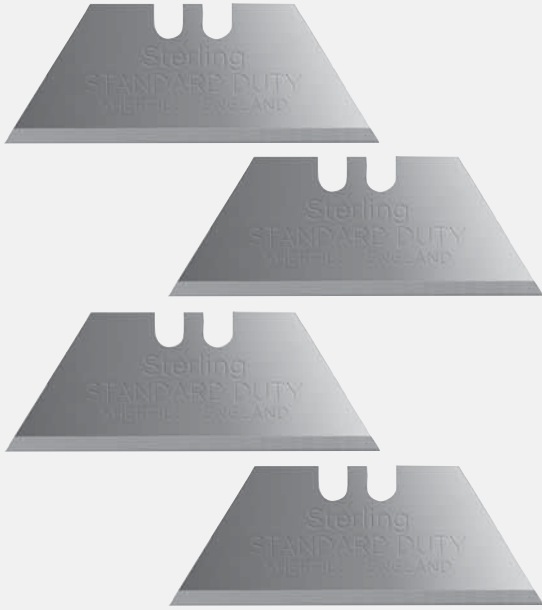

## Sterling® 911 Standard Duty

### STANDARD DUTY TRIMMING KNIFE BLADE

| CODE          | DESCRIPTION      | BOX QTY | CTN QTY |
|---------------|------------------|---------|---------|
| <b>911-2</b>  | Box of 100       | 1       | 44      |
| <b>911-2D</b> | Dispenser of 100 | 1       | 20      |
| <b>911-3</b>  | Pack of 5        | 20*     | 2000    |
| <b>911-4D</b> | Dispenser of 10  | 10*     | 10      |
| <b>911-1</b>  | Card of 5        | 20*     | 10      |

\*Box quantities only      Dimensions    L 50mm    W 18.8mm    T 0.43mm

- Made in Sheffield - England
- Standard Duty blade for lighter weight work
- Ideal for vinyl and some picture framing machines.



**911-4D** 10 blade dispenser



**911-2D** 100 blade dispenser



## Sterling® 941 Trimmer

### 941 TRIMMER BLADE

| CODE          | DESCRIPTION      | BOX QTY | CTN QTY |
|---------------|------------------|---------|---------|
| <b>941-2</b>  | Box of 100       | 1       | 44      |
| <b>941-2D</b> | Dispenser of 100 | 1       | 20      |
| <b>941-3</b>  | Pack of 5        | 20*     | 2000    |
| <b>941-4D</b> | Dispenser of 10  | 10*     | 10      |

\*Box quantities only      Dimensions    L 54.5mm    W 18.8mm    T 0.47mm

- Made in Sheffield - England
- Chisel bevel - i.e ground from one face
- Suits carpet wall trimmers



**941-4D** 10 blade dispenser



**941-2D** 100 blade dispenser



## Sterling® 915 2 Hole Trimmer

### 2 HOLE TRIMMER BLADE

| CODE          | DESCRIPTION     | BOX QTY | CTN QTY |
|---------------|-----------------|---------|---------|
| <b>915-3</b>  | Pack of 5       | 20*     | 20      |
| <b>915-4D</b> | Dispenser of 10 | 10*     | 10      |

\*Box quantities only      Dimensions    L 60mm    W 18.8mm    T 0.43mm

- Made in Sheffield - England
- Suits Carpet trimmer 18-001, See pg. 70 and other selected cutting tools including rubber cutting, carpet laying, wallboard, etc



**915-4D** 10 blade dispenser

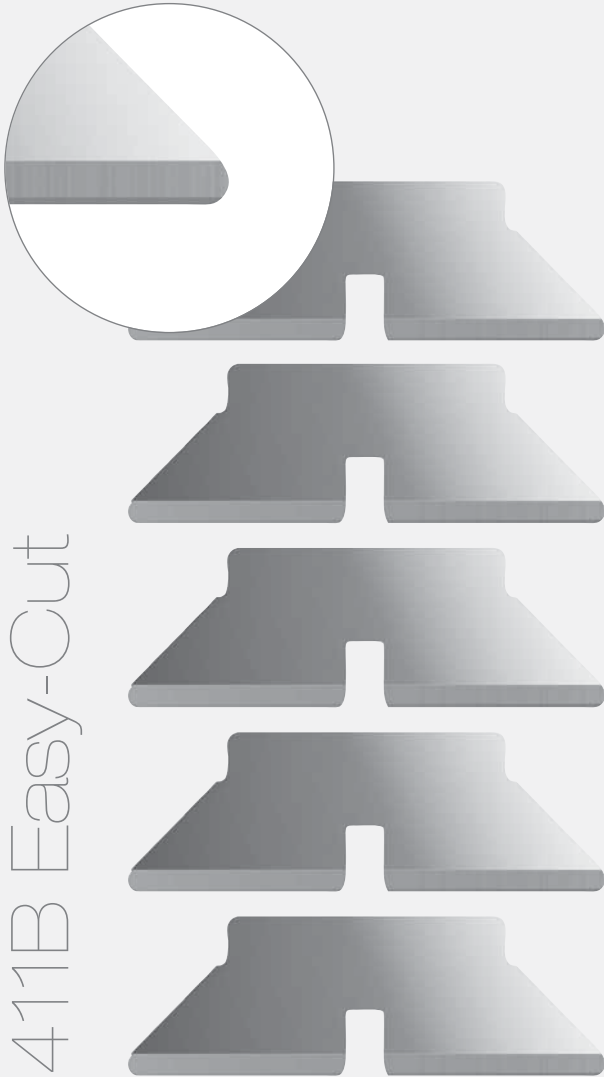

411B Easy-Cut

**REPLACEMENT BLADES FOR EASY CUT KNIFE**

| CODE          | DESCRIPTION | BOX QTY | CTN QTY |
|---------------|-------------|---------|---------|
| <b>411B-1</b> | Card of 10  | 10      | 120     |
| <b>411B-2</b> | Box of 80   | 6       | 120     |

- Suits Easy-Cut knife No: 411 - See pg. 41
- Patented blunt points prevent damage to carton contents
- Box contains inbuilt sharps container for safe disposal of used blades

**411B-1** 10 blade card**411B-2** 80 blade dispenser

## Sterling® 412B Sideslide Blade

**KNIFE BLADE FOR SIDE SLIDE KNIFE**

| CODE        | DESCRIPTION | BOX QTY  | CTN QTY           |
|-------------|-------------|----------|-------------------|
| <b>412B</b> | Tube of 10  | 20       | 800               |
| Dimensions  |             | L 71.8mm | W 17.4mm T 0.60mm |

- Suits 412 Sideslide knife. See pg. 43
- Made in Sheffield - England



## Sterling® 03-096 Extra Long

**EXTRA LONG HEAVY DUTY BLADE**

| CODE          | DESCRIPTION | BOX QTY | CTN QTY           |
|---------------|-------------|---------|-------------------|
| <b>03-096</b> | Tube of 10  | 10      | -                 |
| Dimensions    |             | L 95mm  | W 18.8mm T 0.64mm |

- Extra long blade used in narrow spaces where extra reach is required
- Made in USA
- Ideal for Windscreen Industry



## 9600 Special Hook

### SPECIAL HOOK BLADE

| CODE          | DESCRIPTION | BOX QTY | CTN QTY           |
|---------------|-------------|---------|-------------------|
| <b>9600-3</b> | Pack of 5   | 1       | 1                 |
| Dimensions    |             | L 60mm  | W 12.7mm T 0.65mm |

- Suits Armstrong #S66 vinyl wall trimmer
- Made in USA



*Sterling*

## 963 Centre Hole

### HOOKED TRIMMING KNIFE BLADE WITH CENTRE HOLE

| CODE          | DESCRIPTION     | BOX QTY | CTN QTY |
|---------------|-----------------|---------|---------|
| <b>963-3</b>  | Pack of 5       | 20*     | 2000    |
| <b>963-4D</b> | Dispenser of 10 | 10*     | 10      |

\*Box quantities only      Dimensions    L 50mm    W 18.8mm    T 0.63mm

- Standard depth hook with centre hole suits some carpet trimmer tools
- Made in Sheffield - England



**963-4D** 10 blade dispenser



961 Hooked



*Sterling*

### HOOKED TRIMMING KNIFE BLADE

| CODE          | DESCRIPTION      | BOX QTY | CTN QTY |
|---------------|------------------|---------|---------|
| <b>961-2</b>  | Box of 100       | 1       | 44      |
| <b>961-2D</b> | Dispenser of 100 | 1       | 25      |
| <b>961-3</b>  | Pack of 5        | 20*     | 2000    |
| <b>961-4D</b> | Dispenser of 10  | 10*     | 10      |
| <b>961-1</b>  | Card of 5        | 20*     | 240     |

\*Box quantities only      Dimensions    L 50mm    W 18.8mm    T 0.63mm

- Standard depth hook suits most trimming knives
- Ideal for carpet and rug cutting
- Made in Sheffield - England



**961-4D** 10 blade dispenser



**961-2D** 100 blade dispenser



968 Safety Point



Sterling®

**SAFETY POINT HOOKED TRIMMING KNIFE BLADE**

| CODE          | DESCRIPTION     | BOX QTY | CTN QTY |
|---------------|-----------------|---------|---------|
| <b>968-3</b>  | Pack of 5       | 20*     | 2000    |
| <b>968-4D</b> | Dispenser of 10 | 10*     | 10      |

\*Box quantities only      Dimensions    L 50mm    W 18.8mm    T 0.63mm

- Hook blade with blunt points for safety
- Made in Sheffield - England

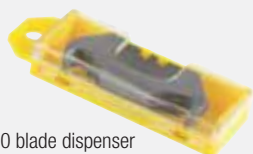
**968-4D** 10 blade dispenser

## Sterling® 964 Medium Hook

**MEDIUM HOOKED TRIMMING KNIFE BLADE**

| CODE           | DESCRIPTION                                 | BOX QTY | CTN QTY |
|----------------|---|---------|---------|
| <b>964-3</b>   | Pack of 5 Made in Sheffield - England       | 20*     | 2000    |
| <b>964-4D</b>  | Dispenser of 10 Made in Sheffield - England | 10*     | 10      |
| <b>104-063</b> | Dispenser of 10 Made in Germany             | 10*     | 100     |

\*Box quantities only      Dimensions    L 50mm    W 18.8mm    T 0.63mm

- Medium depth hook
- Made in Germany or Sheffield - England

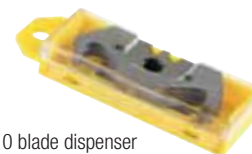
**964-4D** 10 blade dispenser

## Sterling® 962 Deep Hook

**DEEP HOOKED TRIMMING KNIFE BLADE**

| CODE           | DESCRIPTION                                 | BOX QTY | CTN QTY |
|----------------|---|---------|---------|
| <b>962-3</b>   | Pack of 5 Made in Sheffield - England       | 20*     | 2000    |
| <b>962-4D</b>  | Dispenser of 10 Made in Sheffield - England | 10*     | 10      |
| <b>105-063</b> | Dispenser of 10 Made in Germany             | 10*     | 100     |

\*Box quantities only      Dimensions    L 56mm    W 18.8mm    T 0.65mm

- Deep hook suits many trimming knives
- Ideal for carpet and rug cutting
- Made in Germany or Sheffield - England

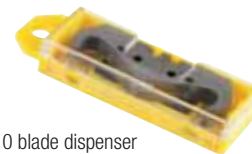
**962-4D** 10 blade dispenser

## 991 Concave



Sterling

### CONCAVE TRIMMING KNIFE BLADE

| CODE          | DESCRIPTION                 | BOX QTY | CTN QTY |
|---------------|-----------------------------|---------|---------|
| <b>991-2</b>  | Box of 100                  | 1       | 44      |
| <b>991-2D</b> | Dispenser of 100            | 1       | 20      |
| <b>991-3</b>  | Pack of 5                   | 20*     | 2000    |
| <b>991-4D</b> | Dispenser of 10             | 10*     | 10      |
| <b>991-1</b>  | Card of 5                   | 20*     | 240     |
| <b>991-TD</b> | Tungsten – Dispenser of 100 | 1       | 20      |

\*Box quantities only      Dimensions    L 58.7mm    W 18.8mm    T 0.63mm

- Suits most trimming knives
- Widely used in carpet and vinyl laying
- Strong tip for durability
- Made in Sheffield - England
- Tungsten blade available ideal for vinyl laying



**991-4D** 10 blade dispenser



**991-2D** 100 blade dispenser



Sterling

## 992 Three Hole

### CONCAVE TRIMMING KNIFE BLADE WITH 3 HOLES

| CODE          | DESCRIPTION     | BOX QTY | CTN QTY |
|---------------|-----------------|---------|---------|
| <b>992-3</b>  | Pack of 5       | 20*     | 2000    |
| <b>992-4D</b> | Dispenser of 10 | 10*     | 10      |

\*Box quantities only      Dimensions    L 58.7mm    W 18.8mm    T 0.63mm

- Three holes suits many machine applications
- Made in Sheffield - England

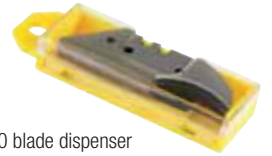

**992-4D** 10 blade dispenser



## 160-063 Long Beak

### GERMAN CONCAVE TRIMMING KNIFE BLADE

| CODE           | DESCRIPTION     | BOX QTY | CTN QTY |
|----------------|-----------------|---------|---------|
| <b>160-063</b> | Dispenser of 10 | 10*     | 100     |

\*Box quantities only      Dimensions    L 59mm    W 18.8mm    T 0.63mm

- Long beak with three holes
- Finer tip for accuracy and control
- Made in Germany



**160-063** 10 blade dispenser

## 03-153 Linoleum



*Sterling*<sup>®</sup>

#### LINOLEUM BLADE

| CODE          | DESCRIPTION | BOX QTY  | CTN QTY  |
|---------------|-------------|----------|----------|
| <b>03-153</b> | Card of 1   | 1        | 10       |
|               | Dimensions  | L 78mm   | W 18.8mm |
|               |             | T 0.80mm |          |

- Suits some fixed blade knives
- Ideal for linoleum cutting
- Made in USA

Carded



## 981 Convex



*Sterling*<sup>®</sup>

#### CONVEX TRIMMING KNIFE BLADE

| CODE         | DESCRIPTION          | BOX QTY    | CTN QTY  |
|--------------|----------------------|------------|----------|
| <b>981-3</b> | Pack of 5            | 20*        | 200      |
|              | *Box quantities only | Dimensions | L 60mm   |
|              |                      | W 18.8mm   | T 0.63mm |

- Suits most trimming knives
- Made in Sheffield - England

Stay sharp with **Sterling snap-off blades**. Just a quick snap of the blade end and you're **ready to go** with a new sharpened end. **From old to new in a split second!**

re-new





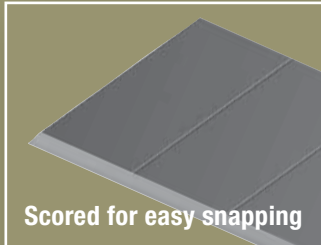

Scored for easy snapping

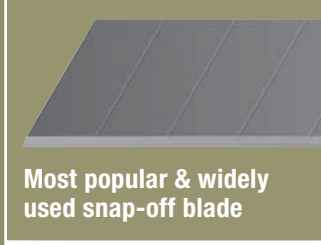

Most popular & widely used snap-off blade



Made in Sheffield, England



# 201 18mm Sheffield – Sterling



**Sterling®**

## 18MM WIDE SHEFFIELD SNAP-OFF BLADE

| CODE         | DESCRIPTION                        | BOX QTY | CTN QTY        |
|--------------|------------------------------------|---------|----------------|
| <b>201-2</b> | Tube of 50 - Sheffield             | 1       | 69             |
| <b>201-4</b> | Dispenser of 10 - Sheffield        | 10      | 500            |
| <b>201-1</b> | Dispenser 10 - on card - Sheffield | 10      | 240            |
| Dimensions   |                                    | L 110mm | W 18mm T 0.5mm |

- Most popular and widely used snap-off blade
- 8 point 18mm wide
- 3-Stage grinding process produces a sharper blade that lasts longer
- Made in Sheffield - England
- Suits all Large 18mm Snap Cutters. *See pgs. 25-31*



**201-4** 10 blade dispenser



**201-1** 10 blades carded

**Sterling**

SNAP-OFF 185

SNAP-OFF BLADES



Sterling®

## 18mm Ultra-Black

### 18MM WIDE ULTRA-BLACK SNAP-OFF BLADE

| CODE           | DESCRIPTION              | BOX QTY | CTN QTY        |
|----------------|--------------------------|---------|----------------|
| <b>201-2BH</b> | Tube of 50 - Ultra Black | 5       | 50             |
| <b>201-4BH</b> | Tube of 10 - Ultra Black | 10      | 200            |
| Dimensions     |                          | L 110mm | W 18mm T 0.5mm |

- 8 point, 18mm wide Ultra Black blade
- Ultra sharp cutting edge
- Suits all 18mm Large Snap Cutters
- 3-Stage grinding process produces a sharper blade that lasts longer



Sterling®

## 18mm Ultra

### 18MM WIDE ULTRA SNAP-OFF BLADE

| CODE           | DESCRIPTION        | BOX QTY | CTN QTY        |
|----------------|--------------------|---------|----------------|
| <b>201-2GR</b> | Tube of 50 - Ultra | 5       | 50             |
| <b>201-4GR</b> | Tube of 10 - Ultra | 10      | 200            |
| Dimensions     |                    | L 110mm | W 18mm T 0.5mm |

- 8 point 18mm wide Ultra blade
- Specially manufactured for the most demanding applications
- Specified by Windscreen manufacturers & rubber belting splicers
- 3-Stage grinding process for sharpness and durability
- Made in Germany



Sterling®

## 1404L 18mm Snap-Off

### 18MM LARGE SNAP-OFF BLADE

| CODE                 | DESCRIPTION     | BOX QTY    | CTN QTY                |
|----------------------|-----------------|------------|------------------------|
| <b>1404L-2</b>       | Tube of 50      | 1          | 40                     |
| <b>1404-L</b>        | Dispenser of 10 | 10*        | 200                    |
| <b>1404L-1</b>       | Card of 10      | 10*        | 100                    |
| <b>01005-1</b>       | Card of 5       | 20*        | 200                    |
| *Box quantities only |                 | Dimensions | L 110mm W 18mm T 0.5mm |

- 8 point 18mm wide
- Popular packaging blade
- Suits all Large 18mm Snap Cutters. See pgs. 25-31



## KDS 18mm Silver

### 18MM HEAVY DUTY SNAP-OFF BLADE

| CODE           | DESCRIPTION            | BOX QTY | CTN QTY        |
|----------------|------------------------|---------|----------------|
| <b>LB-50H</b>  | Tube of 50 - Silver    | 10      | 50             |
| <b>LB-10H</b>  | Tube of 10 - Silver    | 5       | 50             |
| <b>GB-50H*</b> | Tube of 50 - 0.6mm H/D | 5       | 50             |
| <b>GB-10H*</b> | Tube of 10 - 0.6mm H/D | 10      | 200            |
| Dimensions     |                        | L 110mm | W 18mm T 0.6mm |

- LB-50H and LB-10H are standard thickness blades
- GB-10H and GB-50H 0.6mm thick for cutting thick materials
- 8 point, 18mm wide H/D blades are safer and more rigid than normal snap blades
- Suits most 18mm Large Snap Cutters
- Made in Japan



## KDS 18mm Power Black

### 18MM HEAVY DUTY SNAP-OFF BLADE

| CODE             | DESCRIPTION              | BOX QTY | CTN QTY        |
|------------------|--------------------------|---------|----------------|
| <b>KDLB-50BH</b> | Tube of 50 - Power Black | 10      | 200            |
| <b>KDLB-10BH</b> | Tube of 10 - Power Black | 5       | 50             |
| Dimensions       |                          | L 110mm | W 18mm T 0.5mm |

- 8 point, 18mm wide Power-Black Blades
- Extra sharp cutting edge
- Suits all 18mm Large Snap Cutters
- Made in Japan



**KDLB-10BH**  
10 blade pack



**KDLB-50BH**  
50 blade pack



## FLOOR DOT 18mm Snap-Off Blades

### 18MM WIDE LARGE SNAP-OFF BLADE

| CODE           | DESCRIPTION         | BOX QTY | CTN QTY        |
|----------------|---------------------|---------|----------------|
| <b>04-3055</b> | Tube of 10 - Black  | 10      | 40             |
| <b>04-3050</b> | Tube of 10 - Silver | 10      | 40             |
| Dimensions     |                     | L 110mm | W 18mm T 0.5mm |

- Premium triple ground blade for the flooring industry
- Suits all large 18mm Snap cutters - *See pgs. 25-31.*



**NT**

## 18mm NT Large Snap-Off Blade

### 18MM WIDE LARGE SNAP-OFF BLADE

| CODE           | DESCRIPTION       | BOX QTY | CTN QTY         |
|----------------|-------------------|---------|-----------------|
| <b>BL-51P</b>  | Packet of 50 – NT | 10      | 100             |
| <b>BL-150P</b> | Packet of 6 – NT  | 20      | 200             |
| Dimensions     |                   | L 110mm | W 18mm T 0.43mm |

- 8 point 18mm wide
- Made in Japan
- Suits all Large 18mm Snap Cutters. *See pgs. 25-31*



## Sterling® 203 Non-Segmented

### 18MM WIDE LARGE NON-SEGMENTED BLADE

| CODE         | DESCRIPTION | BOX QTY | CTN QTY        |
|--------------|-------------|---------|----------------|
| <b>203-4</b> | Tube of 10  | 10*     | 500            |
| Dimensions   |             | L 110mm | W 18mm T 0.5mm |

- Solid non-segmented blade ideal for food and packaging
- Non snap-off 18mm wide
- Made in Sheffield - England
- Applications where control over blade segments is needed
- Also can be used where segment breakage causes safety issues
- 3 Stage grind for sharpness and durability
- Suits all Large 18mm Snap Cutters. *See pgs. 25-31*

## 207 Extra Large



Sterling®

### 25MM EXTRA WIDE SNAP-OFF BLADE

| CODE           | DESCRIPTION                  | BOX QTY | CTN QTY        |
|----------------|------------------------------|---------|----------------|
| <b>207-1</b>   | Pack of 10                   | 10      | 120            |
| <b>207-2</b>   | Tube of 25                   | 1       | 70             |
| <b>HB-10BH</b> | Tube of 10 - KDS Power Black | 10      | 100            |
| Dimensions     |                              | L 139mm | W 25mm T 0.7mm |

- Wider, thicker, stronger for heavy duty use
- 7 point, 25mm wide, 0.7mm thick
- Suits 700-1 and 701-1 Cutters. *See pgs. 22, 23*
- 207 blades - Made in Sheffield, England
- KDS blade - Made in Japan



**207-1**  
10 blade pack



Sterling®

## 209 Extra Large Non-Segmented

### 25MM EXTRA WIDE NON-SEGMENTED BLADE

| CODE         | DESCRIPTION | BOX QTY | CTN QTY        |
|--------------|-------------|---------|----------------|
| <b>209-4</b> | Tube of 10  | 1       | 10             |
| <b>209-2</b> | Tube of 25  | 1       | 70             |
| Dimensions   |             | L 139mm | W 25mm T 0.7mm |

- Wider, thicker, stronger for heavy duty use
- Non snap-off 25mm wide
- Ideal for food and packaging industry applications where control over blade segments is needed
- Suits 700-1 and 701-1 Cutters. *See pgs. 22-23*
- Made in Sheffield - England



## Sterling® 215 Hooked Snap

### 18MM WIDE HOOKED SNAP-OFF BLADE

| CODE         | DESCRIPTION | BOX QTY | CTN QTY        |
|--------------|-------------|---------|----------------|
| <b>215-4</b> | Tube of 10  | 10      | 10             |
| Dimensions   |             | L 103mm | W 18mm T 0.5mm |

- 4 point, 18mm wide, 0.5mm thick
- Made in Germany
- Suits all Large 18mm Snap Cutters. *See pgs. 25-31*



Sterling®

## Long Reach

### REPLACEMENT BLADE FOR LONG REACH SAFETY KNIFE

| CODE          | DESCRIPTION | BOX QTY | CTN QTY        |
|---------------|-------------|---------|----------------|
| <b>416B-4</b> | Tube of 10  | 1       | 10             |
|               | Dimensions  | L 70mm  | W 18mm T 0.5mm |

- Suits 416-1 Longreach Safety Knife - *See pg. 42*
- Made in Sheffield - England



## NT BDC-200P Sharp Angle

### SHARP ANGLE SEGMENTED REPLACEMENT BLADES

| CODE            | DESCRIPTION                   | BOX QTY | CTN QTY          |
|-----------------|-------------------------------|---------|------------------|
| <b>BDC-200P</b> | Sharp angle replacement (x40) | 10      | 100              |
|                 | Dimensions                    | L 25mm  | W 4.1mm T 0.38mm |

- Pre-segmented blade pieces for easy replacement in tools
- Suits C-3000GP, C-1500P, D-1000 - *See pg. 128*
- Made in Japan



## NT BSL-11P NT Safety Knife Blade

### SAFETY KNIFE REPLACEMENT BLADES

| CODE           | DESCRIPTION       | BOX QTY | CTN QTY        |
|----------------|-------------------|---------|----------------|
| <b>BSL-11P</b> | 18mm Blades (x10) | 10      | 200            |
|                | Dimensions        | L 69mm  | W 18mm T 0.5mm |

- Suits SL-1P Safety Knife - *See pg. 45*
- Made in Japan



## NT BDA-200P Standard Angle

### STANDARD ANGLE SEGMENTED REPLACEMENT BLADES

| CODE            | DESCRIPTION                      | BOX QTY | CTN QTY        |
|-----------------|----------------------------------|---------|----------------|
| <b>BDA-200P</b> | Standard angle replacement (x40) | 10      | 100            |
|                 | Dimensions                       | L 25mm  | W 4mm T 0.38mm |

- Pre-segmented blade pieces for easy replacement in tools
- Suits C-3000GP, C-1500P, D-1000 - *See pg. 128*
- Made in Japan



## NT BA-100 NT

### 9MM WIDE NT SMALL SNAP-OFF BLADE

| CODE          | DESCRIPTION      | BOX QTY | CTN QTY        |
|---------------|------------------|---------|----------------|
| <b>BA-100</b> | Packet of 5 – NT | 10      | 100            |
| Dimensions    |                  | L 87mm  | W 9mm T 0.38mm |

- 13 point 9mm
- Made in Japan
- Suits all Small 9mm Snap Cutters. *See pgs. 33-37*



## Sterling® NT Sharp Angle

### 9MM WIDE SHARP ANGLE SNAP-OFF BLADE

| CODE          | DESCRIPTION                                     | BOX QTY | CTN QTY        |
|---------------|---|---------|----------------|
| <b>1402-4</b> | Tube of 10 Sterling Made in Sheffield - England | 10      | 100            |
| <b>BD-100</b> | Packet of 5 NT Made in Japan                    | 10      | 100            |
| Dimensions    |   | L 87mm  | W 9mm T 0.38mm |

- Sharp angled 9mm wide
- Ideal for precision cutting in Graphic Arts and Sign Writing industries
- Suits most Small 9mm Snap Cutters. *See pgs. 33-37*

# 200 Sheffield



Carded

## Sterling®

### 9MM WIDE SMALL SNAP-OFF BLADE

| CODE          | DESCRIPTION                         | BOX QTY | CTN QTY        |
|---------------|-------------------------------------|---------|----------------|
| <b>200-2</b>  | Tube of 50 - Carbon                 | 1       | 200            |
| <b>200-4</b>  | Tube of 10 - Carbon                 | 10      | 700            |
| <b>200-1</b>  | Card of 10 - Carbon                 | 10      | 100            |
| <b>200-2S</b> | Tube of 50 - <b>Stainless Steel</b> | 1       | 200            |
| <b>200-4S</b> | Tube of 10 - <b>Stainless Steel</b> | 10      | 500            |
| Dimensions    |                                     | L 87mm  | W 9mm T 0.38mm |

- Most universal small snap-off blade
- 13 point 9mm
- Made in Sheffield - England
- Suits all Small 9mm Snap Cutters. *See pgs. 33-37*

202 Non-Segmented



Sterling®

**9MM WIDE SMALL NON-SEGMENTED BLADE**

| CODE                 | DESCRIPTION | BOX QTY    | CTN QTY               |
|----------------------|-------------|------------|-----------------------|
| <b>202-4</b>         | Tube of 10  | 10*        | 800                   |
| *Box quantities only |             | Dimensions | L 85mm W 9mm T 0.40mm |

- Solid non-segmented blade - ideal for food and packaging applications where control over blade segments is needed
- Also can be used where segment breakage causes safety issues
- Non snap-off 9mm wide
- Made in Sheffield - England
- Suits all Small 9mm Snap Cutters. *See pgs. 33-37*

**KDS** 9mm  
Small Snap-off**9MM WIDE KDS SMALL SNAP-OFF BLADES**

| CODE             | DESCRIPTION                  | BOX QTY    | CTN QTY               |
|------------------|------------------------------|------------|-----------------------|
| <b>SB-50H</b>    | Tube of 50 Carbon Steel*     | 5          | 50                    |
| <b>SB-50SH-S</b> | Tube of 50 Stainless Steel** | 5          | 50                    |
|                  |                              | Dimensions | L 87mm W 9mm T 0.38mm |

- 13 point, 9mm wide snap blade
- Suits all Small 9mm Snap Cutters
- Available in \*Carbon Steel or \*\*Stainless Steel
- Made in Japan

Sterling<sup>e</sup> 1403  
9mm Snap-off**9MM WIDE SMALL SNAP-OFF BLADE**

| CODE                 | DESCRIPTION | BOX QTY    | CTN QTY               |
|----------------------|-------------|------------|-----------------------|
| <b>1403-S</b>        | Tube of 10  | 10*        | 500                   |
| <b>02005-1</b>       | Card of 5   | 20*        | 200                   |
| *Box quantities only |             | Dimensions | L 87mm W 9mm T 0.38mm |

- 13 point 9mm
- Popular packaging blade
- Suits all Small 9mm Snap Cutters. *See pgs. 33-37*



# Scraped in.

Used in the **automotive, glazing and cleaning industries**, the **Sterling Single Edge razor blades** are the **most popular** general purpose scraper blade.



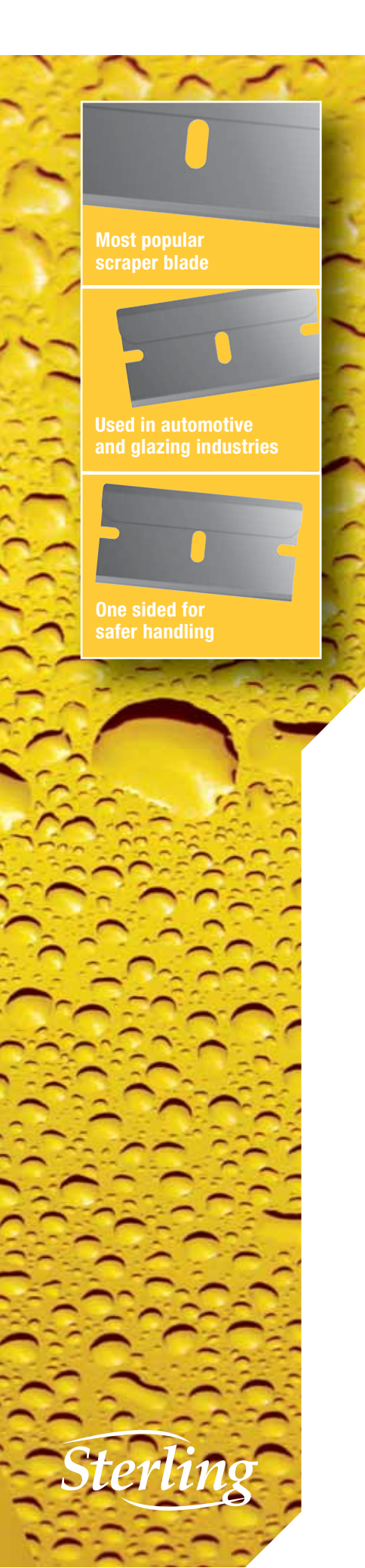

Most popular scraper blade



Used in automotive and glazing industries



One sided for safer handling



# Single Edge Razor Blades

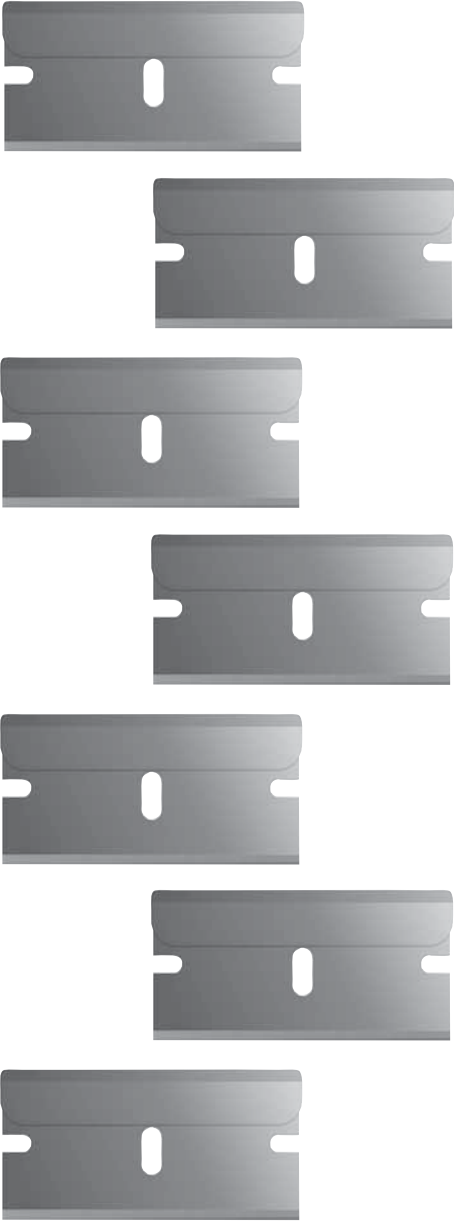

| CODE            | DESCRIPTION                  | BOX QTY | CTN QTY |
|-----------------|------------------------------|---------|---------|
| <b>30-112</b>   | Box of 100 Made in USA       | 1       | 50      |
| <b>US30-112</b> | Box of 100 Made in USA       | 1       | 50      |
| <b>05-491</b>   | Box of 100 Made in USA       | 1       | 50      |
| <b>30-112CL</b> | Clamshell of 100 Made in USA | 1       | 50      |
| <b>61-109</b>   | ULTRAKEEN Box of 100         | 1       | 50      |

\*Box quantities only

| Dimensions | L 39mm | W 19.6mm | T 0.24mm |
|------------|--------|----------|----------|
|------------|--------|----------|----------|

- #9 gauge (.009")
- Most popular scraper blade
- Used in automotive, glazing, cleaning etc.
- Made in USA

# SCRAPING 193

SCRAPING BLADES

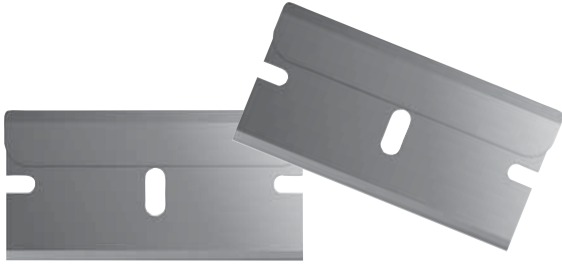

## Sterling® 30-101 Single Edge

### SINGLE EDGE - RAZOR BLADES

| CODE                 | DESCRIPTION            | BOX QTY    | CTN QTY                  |
|----------------------|------------------------|------------|--------------------------|
| <b>30-101</b>        | Pack of 5 Made in USA  | 20*        | 1000                     |
| <b>291-1</b>         | Card of 5 Made in USA  | 20*        | 1000                     |
| <b>SEB10</b>         | Card of 10 Made in USA | 10*        | 500                      |
| <b>35005</b>         | Card of 5 Made in PRC  | 20*        | 480                      |
| *Box quantities only |                        | Dimensions | L 39mm W 19.6mm T 0.24mm |

- #9 gauge (.009")
- Most popular scraper blade
- Used in automotive, glazing, cleaning etc.



## Sterling® 30-117 Heavy Duty

### SINGLE EDGE - HEAVY DUTY RAZOR BLADES

| CODE          | DESCRIPTION            | BOX QTY | CTN QTY          |
|---------------|------------------------|---------|------------------|
| <b>30-117</b> | Box of 100 Made in USA | 1       | 50               |
| Dimensions    |                        | L 39mm  | W 19.6mm T 0.3mm |

- Made in USA. #12 gauge (.012")
- Thicker blade for increased rigidity and heavier scraping applications



## Sterling® 30-327 No Notch

### SINGLE EDGE HEAVY DUTY - RAZOR BLADES

| CODE          | DESCRIPTION            | BOX QTY | CTN QTY          |
|---------------|------------------------|---------|------------------|
| <b>30-327</b> | Box of 100 Made in USA | 1       | 50               |
| Dimensions    |                        | L 39mm  | W 19.6mm T 0.3mm |

- No notch #12 gauge (.012")
- Suitable for picture framing
- Made in USA
- Thicker blade for rigidity



## SEB-25 Plastic

### SINGLE EDGE BLADE

| CODE           | DESCRIPTION            | BOX QTY | CTN QTY |
|----------------|------------------------|---------|---------|
| <b>PSEB-5</b>  | Card of 5 with Scraper | 20      | 120     |
| <b>PSEB-25</b> | Packet of 25           | 10      | 100     |

- Fits all single edge scraper tools
- Double sided gives 2 edges per blade
- Does not mark auto paint and other finished surfaces
- Provides increased safety

# Scraper/Blade Selector

## Blades to suit

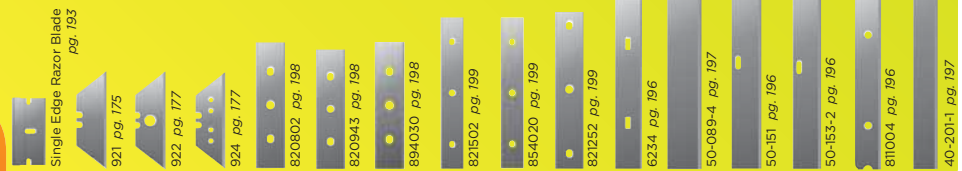

| Scraper | Page | Single Edge Razor Blade<br>pg. 193 | 921<br>pg. 175 | 922<br>pg. 177 | 924<br>pg. 177 | 820802<br>pg. 198 | 820943<br>pg. 198 | 894030<br>pg. 198 | 821502<br>pg. 199 | 854020<br>pg. 199 | 821252<br>pg. 199 | 6234<br>pg. 196 | 50-089-4<br>pg. 197 | 50-151<br>pg. 196 | 50-153-2<br>pg. 196 | 811004<br>pg. 196 | 40-201-1<br>pg. 197 |
|---------|------|------------------------------------|----------------|----------------|----------------|-------------------|-------------------|-------------------|-------------------|-------------------|-------------------|-----------------|---------------------|-------------------|---------------------|-------------------|---------------------|
| 80-200  | 87   | •                                  |                |                |                |                   |                   |                   |                   |                   |                   |                 |                     |                   |                     |                   |                     |
| 80-202  | 88   | •                                  |                |                |                |                   |                   |                   |                   |                   |                   |                 |                     |                   |                     |                   |                     |
| 208     | 88   | •                                  |                |                |                |                   |                   |                   |                   |                   |                   |                 |                     |                   |                     |                   |                     |
| 80-214  | 89   | •                                  |                |                |                |                   |                   |                   |                   |                   |                   |                 |                     |                   |                     |                   |                     |
| 14-708  | 89   | •                                  |                |                |                |                   |                   |                   |                   |                   |                   |                 |                     |                   |                     |                   |                     |
| TH48A   | 92   |                                    | •              | •              | •              |                   |                   |                   |                   |                   |                   |                 |                     |                   |                     |                   |                     |
| HDSCR   | 91   |                                    |                |                |                |                   | •                 | •                 |                   |                   |                   |                 |                     |                   |                     |                   |                     |
| WPSCR   | 91   |                                    |                |                |                |                   | •                 | •                 |                   |                   |                   |                 |                     |                   |                     |                   |                     |
| 1910    | 91   |                                    |                |                |                |                   |                   |                   |                   |                   |                   | •               |                     |                   |                     |                   |                     |
| 1915    | 90   |                                    |                |                |                |                   |                   |                   | •                 | •                 |                   |                 |                     |                   |                     |                   |                     |
| 1916    | 90   |                                    |                |                |                |                   |                   |                   | •                 | •                 |                   |                 |                     |                   |                     |                   |                     |
| 1917    | 90   |                                    |                |                |                |                   |                   |                   | •                 | •                 |                   |                 |                     |                   |                     |                   |                     |
| 1918    | 90   |                                    |                |                |                |                   |                   |                   |                   |                   | •                 |                 |                     |                   |                     |                   |                     |
| 1919    | 91   |                                    |                |                |                | •                 |                   |                   |                   |                   |                   |                 |                     |                   |                     |                   |                     |
| 14-010  | 93   |                                    |                |                |                |                   |                   |                   |                   |                   |                   | •               |                     | •                 | •                   | •                 |                     |
| 14-012  | 93   |                                    |                |                |                |                   |                   |                   |                   |                   |                   | •               |                     | •                 | •                   | •                 |                     |
| 14-030  | 93   |                                    |                |                |                |                   |                   |                   |                   |                   |                   | •               |                     | •                 | •                   | •                 |                     |
| 14-048  | 93   |                                    |                |                |                |                   |                   |                   |                   |                   |                   | •               |                     | •                 | •                   | •                 |                     |
| TH6230  | 93   |                                    |                |                |                |                   |                   |                   |                   |                   |                   | •               |                     | •                 |                     |                   |                     |
| 14-088  | 94   |                                    |                |                |                |                   |                   |                   |                   |                   |                   |                 | •                   |                   |                     |                   |                     |
| 14-086  | 94   |                                    |                |                |                |                   |                   |                   |                   |                   |                   |                 |                     |                   |                     |                   | •                   |

## Wall & Floor Blade



### 4" SCRAPER BLADE

| CODE            | DESCRIPTION | BOX QTY | CTN QTY         |
|-----------------|-------------|---------|-----------------|
| <b>50-151-4</b> | Tube of 10  | 10      | 100             |
| <b>50-153-2</b> | Box of 100  | 1       | 30              |
| Dimensions      |             | L 102mm | W 14mm T 0.52mm |

- Heavy Duty 100mm (4") Single Edge Scraper Blade
- Suits scrapers No. TH6230, 14-010, 14-012, 14-030, 14-048 plus most 4" scrapers. *See pg. 93*
- Made in USA

**50-151-4** Tube of 10

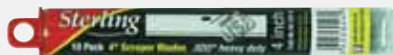

## FLOOR DOT 4" Scraper Blade

### 4" SCRAPER BLADE

| CODE           | DESCRIPTION | BOX QTY | CTN QTY         |
|----------------|-------------|---------|-----------------|
| <b>04-3027</b> | Tube of 10  | 10      | -               |
| Dimensions     |             | L 102mm | W 14mm T 0.52mm |

- Premium blade with 3 stage edge grinding
- Ideal for flooring applications
- Suit scrapers no: 14-010, 14-012, 14-030, 14-048 plus many other 4" scrapers  
*See pg. 93*

**Tube of 10**



## Sterling Multi-Use

### 4" SCRAPER BLADE

| CODE        | DESCRIPTION            | BOX QTY | CTN QTY         |
|-------------|------------------------|---------|-----------------|
| <b>6234</b> | Dispenser of 10 Carded | 20      | 200             |
| Dimensions  |                        | L 102mm | W 14mm T 0.50mm |

- 100mm (4") Single Edge Scraper Blade
- Suits code No. 1910 4" Window Scraper - *See pg. 91*, TH6230 - *See pg. 93* and most other 4" scrapers

**Carded**



## Sterling Glass Scraper Blade

### 4" SINGLE SIDED SCRAPER BLADE

| CODE          | DESCRIPTION | BOX QTY | CTN QTY        |
|---------------|-------------|---------|----------------|
| <b>811004</b> | Pack of 10  | 1       | 1              |
| Dimensions    |             | L 100mm | W 14mm T 0.4mm |

- Made in Germany
- 100mm (4") Single Edge Scraper Blade suits Ettore Quick Guard, Ettore Super Scraper, Unger Window Scraper, Eureka Metal Scraper and other 4" Scrapers

**Carded**



## Sterling® Floor & Wall Blade

### 5" SCRAPER BLADE

| CODE                              | DESCRIPTION | BOX QTY | CTN QTY |
|-----------------------------------|-------------|---------|---------|
| <b>50-089-4</b>                   | Tube of 10  | 1       | 20      |
| Dimensions L 125mm W 19mm T 0.9mm |             |         |         |

- 125mm (5") Single Edge Scraper Blade
- Suits No. 14-088 5" Scraper. *See pg. 94*

## Sterling® Floor & Wall Blade

### 6" SCRAPER BLADE

| CODE                               | DESCRIPTION | BOX QTY | CTN QTY |
|------------------------------------|-------------|---------|---------|
| <b>50-085-4</b>                    | Pack of 10  | 1       | 1       |
| Dimensions L 148mm W 24mm T 0.68mm |             |         |         |

- 148mm (6") Single Edge Scraper Blade

## FLOOR DOT 8" Scraper Blade

### 8" SCRAPER BLADE

| CODE                                 | DESCRIPTION | BOX QTY | CTN QTY |
|--------------------------------------|-------------|---------|---------|
| <b>04-3032-1</b>                     | Pack of 10  | 10      | -       |
| Dimensions L 230mm W 18.7mm T 0.88mm |             |         |         |

- Premium blade with triple edge grinding
- Ideal for flooring applications
- Suit 14-086 and 03-0016 Scrapers

Tube of 10



## Flooring Blade

Sterling®

### 8" SCRAPER BLADE

| CODE                              | DESCRIPTION | BOX QTY | CTN QTY |
|-----------------------------------|-------------|---------|---------|
| <b>40-201-4</b>                   | Tube of 10  | 1       | 10      |
| Dimensions L 204mm W 19mm T 0.9mm |             |         |         |

- 204mm (8") Single Edge Scraper Blade
- Made in USA
- Suits 14-086 *See pg. 94*, and 03-0016 *See pg. 81*, 8" Extendable Floor Scrapers.

40-201-4 Tube of 10



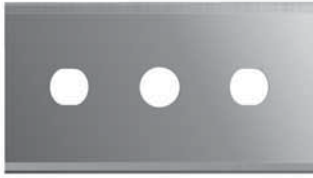

Sterling®

## Snappy Blade

### 40MM DOUBLE SIDED SCRAPER BLADE

| CODE          | DESCRIPTION | BOX QTY | CTN QTY        |
|---------------|-------------|---------|----------------|
| <b>820402</b> | Pack of 10  | 1       | 1              |
| Dimensions    |             | L 40mm  | W 22mm T 0.2mm |

- Suits Snappy Scraper
- Made in Germany



Sterling®

## Handy Blade

### 80MM DOUBLE SIDED SCRAPER BLADE

| CODE           | DESCRIPTION | BOX QTY | CTN QTY         |
|----------------|-------------|---------|-----------------|
| <b>820802</b>  | Pack of 10  | 1       | 1               |
| <b>852-020</b> | Pack of 25  | 1       | 1               |
| Dimensions     |             | L 80mm  | W 22mm T 0.22mm |

- Made in Germany
- Suits No. 1919 Handy Scraper. *See pg. 91*



Carded



94mm

Sterling®

### 94MM DOUBLE SIDED SCRAPER BLADE

| CODE           | DESCRIPTION | BOX QTY | CTN QTY        |
|----------------|-------------|---------|----------------|
| <b>820943</b>  | Pack of 10  | 1       | 1              |
| <b>894-030</b> | Pack of 25  | 1       | 1              |
| Dimensions     |             | L 94mm  | W 22mm T 0.3mm |

- Made in Germany
- Suits No. HDSCR Black Scraper and WPSCR Scraper - *See pg. 91*
- Also suits other 94mm (4") plastic scrapers



Carded



Sterling®

## Unger Style

### 4" DOUBLE SIDED SCRAPER BLADE

| CODE          | DESCRIPTION                       | BOX QTY | CTN QTY |
|---------------|-----------------------------------|---------|---------|
| <b>821002</b> | Pack of 10 (0.2mm thick)          | 1       | 1       |
|               | Dimensions L 100mm W 22mm T 0.2mm |         |         |

- 100mm 4" Double Sided Blade
- Made in Germany
- Suits Unger Trim Scraper



Carded



Sterling®

## Champion Style

### 5" DOUBLE SIDED SCRAPER BLADE

| CODE          | DESCRIPTION                       | BOX QTY | CTN QTY |
|---------------|-----------------------------------|---------|---------|
| <b>821252</b> | Pack of 10                        | 1       | 1       |
|               | Dimensions L 125mm W 22mm T 0.2mm |         |         |

- 125mm 5" Double Sided Blade
- Made in Germany
- Suits No. 1918 Champion Scraper. *See pg. 90*



Carded

## Triumph Style



Sterling®

### 6" DOUBLE SIDED SCRAPER BLADE

| CODE            | DESCRIPTION                       | BOX QTY | CTN QTY |
|-----------------|-----------------------------------|---------|---------|
| <b>821502</b>   | Pack of 10                        | 1       | 1       |
| <b>854-020</b>  | Pack of 25                        | 1       | 1       |
| <b>854-020B</b> | Each in box 200                   | 200     | 200     |
|                 | Dimensions L 152mm W 22mm T 0.2mm |         |         |

- 152mm 6" Double Sided Blade
- Made in Germany
- Suits No. 1915, 1916 and 1917 Triumph Mk2 Scraper. *See pg. 90*



Carded

Detailed and precision work requires the right tools, and the **Sterling No.11 Craft Blade** is the **most popular general purpose craft blade** in our range. **Quality manufactured** for detailed work!



Detail negotiation



Most popular blade for graphics cutting

Great for detail cutting work

Made in USA

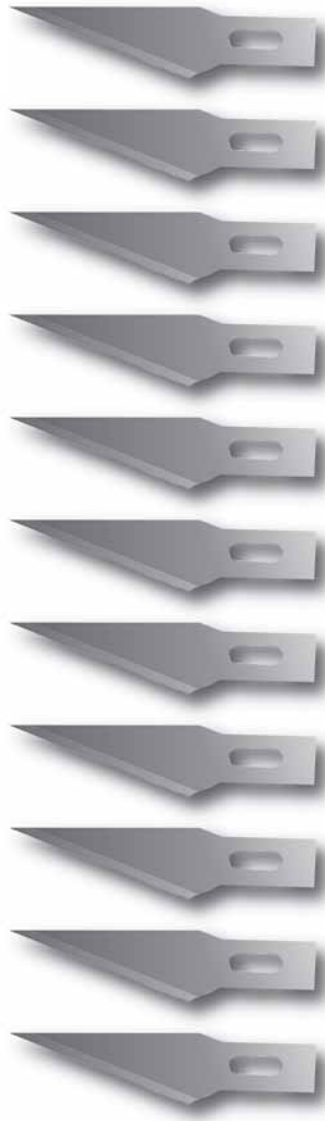

# No.11 Craft Blade



## NO. 11 CRAFT BLADE

| CODE            | DESCRIPTION              | BOX QTY | CTN QTY          |
|-----------------|--------------------------|---------|------------------|
| <b>01-111-2</b> | Box of 100 - Made in USA | 1       | 10               |
| <b>111-1</b>    | Card of 5 - Made in USA  | 20      | 20               |
| <b>01-113-2</b> | Box of 100 - Made in UK  | 1       | 10               |
| Dimensions      |                          | L 39mm  | W 8.5mm T 0.53mm |

- Most popular craft blade for detail and graphics cutting
- Suits art knives 50001 *See pg. 125*, 50003 *See pg. 126*.



Carded



Box



Graphic Arts 2011

## No.10 Craft Blade



| CODE            | DESCRIPTION | BOX QTY | CTN QTY          |
|-----------------|-------------|---------|------------------|
| <b>01-101-2</b> | Box of 100  | 1       | 10               |
| <b>01-103-1</b> | Card of 5   | 20      | 20               |
| Dimensions      |             | L 37mm  | W 8.5mm T 0.53mm |

- General purpose hobby and craft blade
- Made in USA
- Suits art knives 50001 See pg. 125, 50003. See pg. 126

Carded



## No.16 Craft Blade

| CODE            | DESCRIPTION | BOX QTY | CTN QTY          |
|-----------------|-------------|---------|------------------|
| <b>01-161-2</b> | Box of 100  | 1       | 10               |
| <b>01-163-1</b> | Card of 5   | 20      | 20               |
| Dimensions      |             | L 35mm  | W 7.8mm T 0.53mm |

- Stencil blade
- Made in USA
- Suits art knives 50001 See pg. 125, 50003. See pg. 126

Carded



## No.17 Craft Blade

| CODE            | DESCRIPTION | BOX QTY | CTN QTY          |
|-----------------|-------------|---------|------------------|
| <b>01-173-1</b> | Card of 5   | 1       | 10               |
| Dimensions      |             | L 38mm  | W 8.9mm T 0.53mm |

- Small style Chisel blade
- Made in USA
- Suits art knives 50001 See pg. 125, 50003. See pg. 126

Carded



## No.18 Craft Blade

| CODE            | DESCRIPTION | BOX QTY | CTN QTY           |
|-----------------|-------------|---------|-------------------|
| <b>01-181-2</b> | Box of 100  | 1       | 8                 |
| <b>01-183-1</b> | Card of 5   | 1       | 10                |
| Dimensions      |             | L 45mm  | W 12.8mm T 0.65mm |

- Large style chisel blade
- Made in USA
- Suits 50002, 50005 art knives. See pg. 126

Carded





## No.23 Craft Blade

| CODE                                  | DESCRIPTION     | BOX QTY | CTN QTY |
|---------------------------------------|-----------------|---------|---------|
| <b>01-231-2</b>                       | Box of 100      | 1       | 8       |
| <b>01-231TNC</b>                      | TiN Coated each | 1       | 100     |
| Dimensions L 46.2mm W 10.0mm T 0.64mm |                 |         |         |

- Double edged blade
- Made in USA
- Suits 50002, 50005 art knives. *See pg. 126*
- Special Tin Coated blade available

**01-231TNC** – TiN Coated



## No.19 Craft Blade

| CODE            | DESCRIPTION             | BOX QTY | CTN QTY |
|-----------------|-------------------------|---------|---------|
| <b>01-191-2</b> | Box of 100              | 1       | 8       |
| <b>01-192-2</b> | Box of 100 single bevel | 1       | 8       |

- Suits selected mat cutting machines in the picture framing industry
- Suits 50002, 50005 art knives - *See pg. 126*
- Made in USA



## No.2 Craft Blade

| CODE                              | DESCRIPTION        | BOX QTY | CTN QTY |
|-----------------------------------|--------------------|---------|---------|
| <b>01-201-2</b>                   | Plastic Box of 100 | 1       | 8       |
| <b>01-203-1</b>                   | Card of 5          | 1       | 10      |
| Dimensions L 47mm W 10mm T 0.64mm |                    |         |         |

- Large style sharp angle blade
- Made in USA
- Suits 50002, 50005 art knives. *See pg. 126*



## Swann-Morton No.1 Craft Tool Blade

| CODE                            | DESCRIPTION | BOX QTY | CTN QTY |
|---------------------------------|-------------|---------|---------|
| <b>1241</b>                     | Box of 50   | 1       | 1       |
| Dimensions L 55mm W 8mm T 0.4mm |             |         |         |

- Made in Sheffield - England



## Swann-Morton No.2 Craft Tool Blade

| CODE                             | DESCRIPTION | BOX QTY | CTN QTY |
|----------------------------------|-------------|---------|---------|
| <b>1242</b>                      | Box of 50   | 1       | 1       |
| Dimensions L 51mm W 12mm T 0.4mm |             |         |         |

- Made in Sheffield - England



## Swann-Morton No.3 Craft Tool Blade

| CODE                            | DESCRIPTION | BOX QTY | CTN QTY |
|---------------------------------|-------------|---------|---------|
| <b>1243</b>                     | Box of 50   | 1       | 1       |
| Dimensions L 46mm W 8mm T 0.4mm |             |         |         |

- Made in Sheffield - England

## Straight Edge Keyhole



Sterling®

### STRAIGHT EDGE KEYHOLE BLADE

| CODE          | DESCRIPTION     | BOX QTY  | CTN QTY           |
|---------------|-----------------|----------|-------------------|
| <b>401-2</b>  | Box of 100      | 1        | 1                 |
| <b>401-1</b>  | Card of 3       | 20*      | 20                |
| <b>401TNC</b> | TiN Coated each | 1        | 100               |
| Dimensions    |                 | L 58.5mm | W 10.9mm T 0.63mm |

- Used for plastic slitting and mouldings
- Suits #SMOR - See pg. 128
- Made in Sheffield - England
- Special TiN Coated blade available

**401TNC** – TiN Coated



**Carded**



Sterling®

## Convex Keyhole

### CONVEX KEYHOLE BLADE

| CODE          | DESCRIPTION     | BOX QTY  | CTN QTY        |
|---------------|-----------------|----------|----------------|
| <b>404-2</b>  | Box of 50       | 1        | 1              |
| <b>404-1</b>  | Card of 3       | 20*      | 20             |
| <b>404TNC</b> | TiN Coated each | 1        | 50             |
| Dimensions    |                 | L 50.1mm | W 9mm T 0.63mm |

- Used in Poultry machine
- Suits #SMOR - See pg. 128
- Made in Sheffield - England
- Special TiN Coated blade available

**404TNC** – TiN Coated



## Sterling® Short Angle Keyhole

### SHORT ANGLE KEYHOLE BLADE

| CODE          | DESCRIPTION     | BOX QTY  | CTN QTY        |
|---------------|-----------------|----------|----------------|
| <b>405-2</b>  | Box of 100      | 1        | 1              |
| <b>405-1</b>  | Card of 3       | 20*      | 20             |
| <b>405TNC</b> | TiN Coated each | 1        | 100            |
| Dimensions    |                 | L 43.8mm | W 9mm T 0.63mm |

- Used in plastic slitting
- Suits SMOR - See pg. 128
- Made in Sheffield - England
- Special TiN Coated blade available

**405TNC** – TiN Coated



**Carded**





## Sterling® Long Angle Keyhole

### LONG ANGLE KEYHOLE BLADE

| CODE          | DESCRIPTION     | BOX QTY  | CTN QTY        |
|---------------|-----------------|----------|----------------|
| <b>406-2</b>  | Box of 100      | 1        | 1              |
| <b>406-1</b>  | Card of 3       | 20*      | 20             |
| <b>406TNC</b> | TiN Coated each | 1        | 100            |
|               | Dimensions      | L 52.7mm | W 9mm T 0.63mm |

- Used in plastic slitting
- Suits #SMOR - See pg. 128
- Made in Sheffield - England
- Special TiN Coated blade available

**406TNC** – TiN Coated



**Carded**



## Sterling® Pocket Knife

### POCKET KNIFE BLADE

| CODE         | DESCRIPTION | BOX QTY  | CTN QTY          |
|--------------|-------------|----------|------------------|
| <b>3088B</b> | Card of 1   | 1        | 12               |
|              | Dimensions  | L 65.2mm | W 10.2mm T 1.0mm |

- Stainless Steel to suit 3088 pocket knife. See pg. 57

**Carded**



## Sterling® Laila

### LAILA CRAFT BLADE

| CODE         | DESCRIPTION | BOX QTY  | CTN QTY          |
|--------------|-------------|----------|------------------|
| <b>407-3</b> | Pack of 5   | 20*      | 20               |
|              | Dimensions  | L 44.2mm | W 9.1mm T 0.64mm |

- Suits some picture framing machines
- Made in USA



## Sterling® Dexter

### DEXTER BLADE

| CODE             | DESCRIPTION | BOX QTY | CTN QTY        |
|------------------|-------------|---------|----------------|
| <b>13-2202-2</b> | Box of 100  | 1       | 1              |
| <b>2202-1</b>    | Card of 5   | 20*     | 20             |
|                  | Dimensions  | L 44mm  | W 9mm T 0.63mm |

- Suits a Dexter knife in a C&H machine
- Made in USA



## 33710 Small Round

### SMALL ROUND ROUTER BLADE

| CODE             | DESCRIPTION             | BOX QTY | CTN QTY |
|------------------|-------------------------|---------|---------|
| <b>33710</b>     | Card of 2 - Techni-Edge | 12      | 12      |
| <b>05-0091-3</b> | Card of 2 Exacto        | 10      | 10      |

- Used for vinyl flooring and hobby work
- Made in USA
- Suits 50002, 50005 art knives. *See pg. 126*



## 33720 Diamond

### DIAMOND ROUTER BLADE

| CODE             | DESCRIPTION             | BOX QTY | CTN QTY |
|------------------|-------------------------|---------|---------|
| <b>33720</b>     | Card of 2 - Techni-Edge | 12      | 12      |
| <b>05-0091-1</b> | Card of 2 Exacto        | 10      | 10      |

- Used for vinyl flooring and hobby work
- Made in USA
- Suits 50002, 50005 art knives. *See pg. 126*



## 33730 Large Round

### LARGE ROUND ROUTER BLADE

| CODE             | DESCRIPTION             | BOX QTY | CTN QTY |
|------------------|-------------------------|---------|---------|
| <b>33730</b>     | Card of 2 - Techni-Edge | 12      | 12      |
| <b>05-0091-4</b> | Card of 2 Exacto        | 10      | 10      |

- Used for vinyl flooring and hobby work
- Made in USA
- Suits 50002, 50005 art knives. *See pg. 126*



## 33740 Flat Rectangular

### FLAT RECTANGULAR ROUTER BLADE

| CODE             | DESCRIPTION             | BOX QTY | CTN QTY |
|------------------|-------------------------|---------|---------|
| <b>33740</b>     | Card of 2 - Techni-Edge | 12      | 12      |
| <b>05-0091-2</b> | Card of 2 Exacto        | 10      | 10      |

- Used for vinyl weld trimming and hobby work
- Made in USA
- Suits 50002, 50005 art knives. *See pg. 126*

## 28mm Rotary

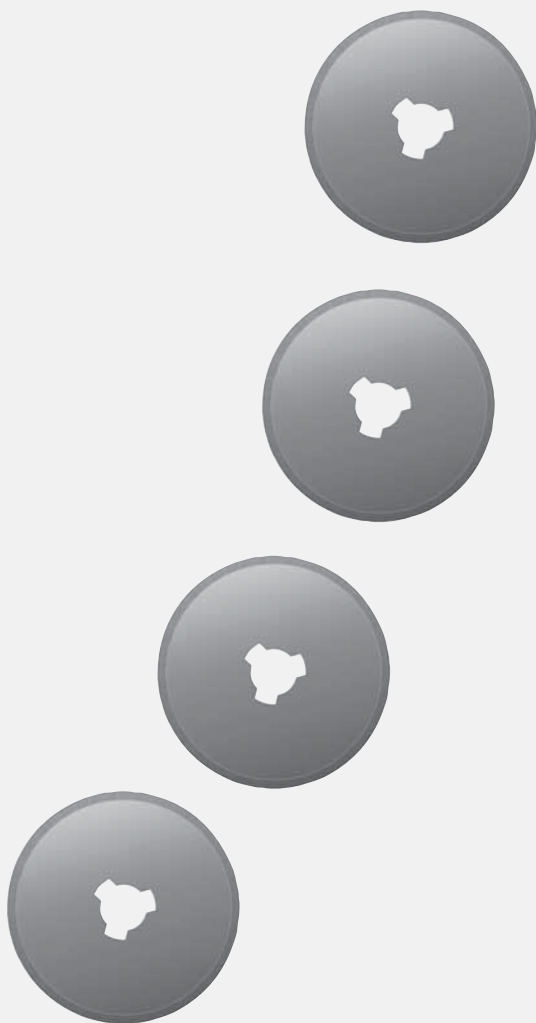

Sterling®

**28MM ROTARY CUTTER BLADE**

| CODE         | DESCRIPTION | BOX QTY | CTN QTY |
|--------------|-------------|---------|---------|
| <b>RB-03</b> | Card of 2   | 1       | 60      |
| Dimensions   |             | ø 28mm  | T 0.3mm |

- 28mm diameter
- Suits RC-02 *See pg. 135, 441-1* *See pg. 48* and OLFA 28mm Rotary cutters
- SKS-7 Tungsten Alloy Steel

**Carded**

## 28mm Skip



Sterling®

**28MM SKIP ROTARY CUTTER BLADE**

| CODE         | DESCRIPTION | BOX QTY | CTN QTY |
|--------------|-------------|---------|---------|
| <b>SB-06</b> | Card of 2   | 2       | 60      |
| Dimensions   |             | ø 28mm  | T 0.3mm |

- Card of 2 blades
- 28mm diameter
- Suits RC-02. *See pg. 135*
- SKS-7 Tungsten Alloy Steel

## 45mm Rotary



Sterling®

## 45mm Rotary

### 45MM ROTARY CUTTER BLADE

| CODE           | DESCRIPTION            | BOX QTY | CTN QTY |
|----------------|------------------------|---------|---------|
| <b>RB-01</b>   | Card of 1              | 1       | 60      |
| <b>RB-01-2</b> | Bulk pack of 50 blades | 50*     | -       |

\*Box quantities only      Dimensions    ø 45mm    T 0.3mm

- 45mm diameter
- Suits RC-12 and OLFA 45mm Rotary Cutters. See pg. 135
- SKS-7 Tungsten Alloy Steel



Carded

## 60mm Rotary

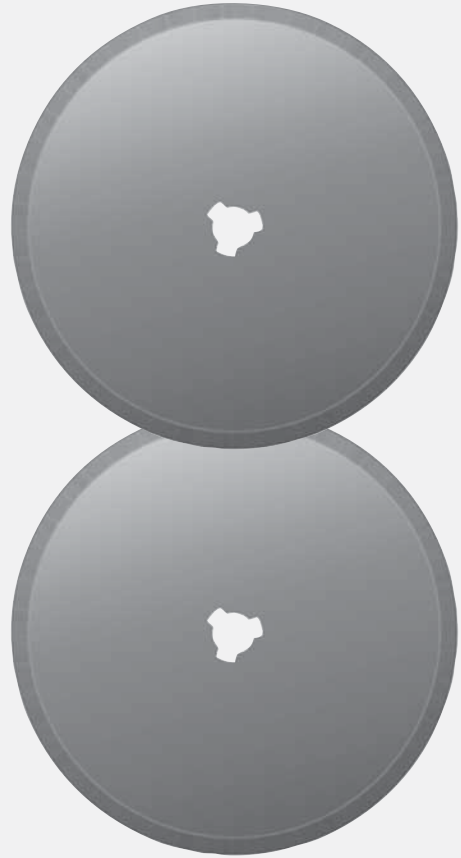

Sterling®

## 60mm Rotary

### 60MM EXTRA LARGE ROTARY CUTTER BLADE

| CODE         | DESCRIPTION | BOX QTY | CTN QTY |
|--------------|-------------|---------|---------|
| <b>RB-60</b> | Card of 1   | 1       | 40      |
|              | Dimensions  | ø 60mm  | T 0.4mm |

- 60mm diameter
- Suits OLFA 60mm Rotary Cutters
- SKS-7 Tungsten Alloy Steel



Carded



## .012 Mat

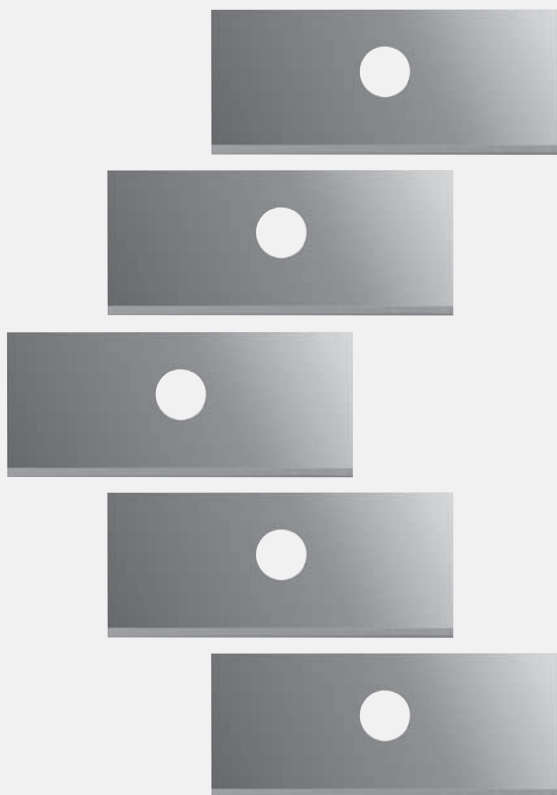

Sterling®

**MAT CUTTER BLADE .012" THICKNESS**

| CODE                 | DESCRIPTION            | BOX QTY    | CTN QTY                   |
|----------------------|------------------------|------------|---------------------------|
| <b>1200D</b>         | Pack of 5 Double Bevel | 20*        | 2000                      |
| <b>1200S</b>         | Pack of 5 Single Bevel | 20*        | 2000                      |
| *Box quantities only |                        | Dimensions | L 44.6mm W 18.8mm T 0.3mm |

- Suits some C&H and other mat cutting machines
- Made in Sheffield - England

## .015 Mat

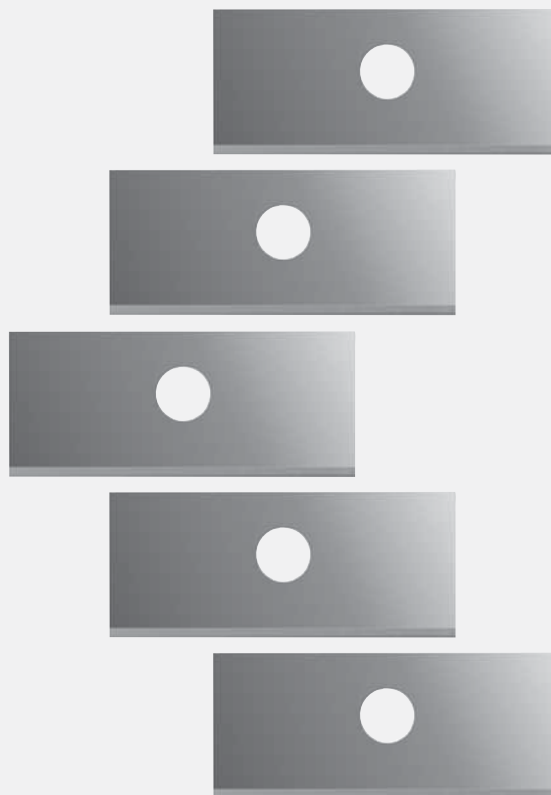

Sterling®

**MAT CUTTER BLADE .015" THICKNESS**

| CODE                 | DESCRIPTION            | BOX QTY    | CTN QTY                    |
|----------------------|------------------------|------------|----------------------------|
| <b>1500D</b>         | Pack of 5 Double Bevel | 20*        | 2000                       |
| <b>1500S</b>         | Pack of 5 Single Bevel | 20*        | 2000                       |
| *Box quantities only |                        | Dimensions | L 44.6mm W 18.8mm T 0.38mm |

- Suits some C&H and other mat cutting machines
- Made in Sheffield - England

**Sterling slitting blades** are super sharp.  
**Made in Germany** using **high tech** processes  
and materials and **available in long life coatings**,  
they make plastics slitting easy work.



Widely used for  
plastics slitting



Three hole, round cornered



Long life TiN  
coated blades available

Rapid work

*Sterling*

# Round Tech



**40-010TNC** – TiN Coated



### ROUND CORNERED TECHNICAL BLADE

| CODE           | DESCRIPTION                 | BOX QTY | CTN QTY |
|----------------|-----------------------------|---------|---------|
| <b>40-010</b>  | Box of 10 Light Duty 0.1mm  | 10      | 100     |
| <b>420-4</b>   | Pack of 10 Heavy Duty 0.4mm | 10      | 100     |
| <b>420 TNC</b> | TiN Coated 0.4mm - Gold     | 1       | 1       |
|                | Dimensions L 43.5mm W 22mm  |         |         |

- Widely used for plastic slitting
- Three hole, round cornered
- Made in Germany
- Long Life TiN Coatings available
- Suits 440-1 - See pg. 48, 18-002 - See pg. 70, 04-0499 - See pg. 83

# Square Tech

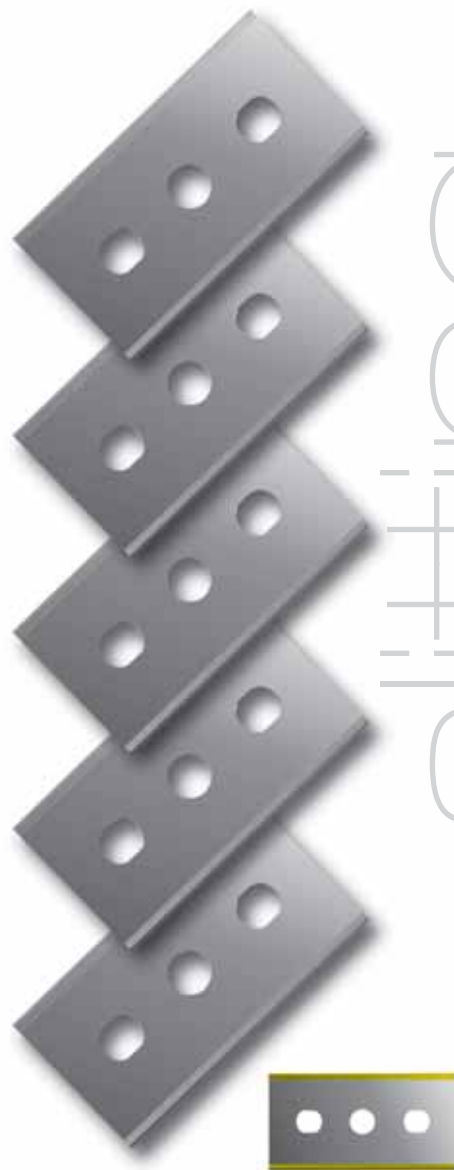

**80-020TNC** – TiN Coated



### SQUARE CORNERED TECHNICAL BLADE

| CODE             | DESCRIPTION                 | BOX QTY | CTN QTY |
|------------------|-----------------------------|---------|---------|
| <b>80-020</b>    | Pack of 10 Light Duty 0.2mm | 10      | 100     |
| <b>80-010TNC</b> | TiN Coated 0.1mm - gold     | 1       | 200     |
| <b>80-015TNC</b> | TiN Coated 0.15mm - gold    | 1       | 200     |
| <b>80-040</b>    | Pack of 10 Heavy Duty 0.4mm | 10      | 100     |
|                  | Dimensions L 43.5mm W 22mm  |         |         |

- Widely used for plastic slitting
- Three hole, square cornered
- Made in Germany
- Long Life TiN Coatings available
- Suits 470-1 – See pg. 50

# Slitting 211

## Round Slotted



### ROUND CORNERED SLOTTED BLADE

| Code             | Description                    | Box Qty  | Ctn Qty                 |
|------------------|--------------------------------|----------|-------------------------|
| <b>40-101-2</b>  | Box of 100                     | 1        | 50                      |
| <b>40-101-4</b>  | Pack of 10                     | 10       | 10                      |
| <b>40-101C</b>   | Cryo Treated Box of 100        | 1        | 1                       |
| <b>40-101TNC</b> | TiN Coated each - Gold         | 1        | 200                     |
| <b>40-101TCN</b> | TiCN Coated each - Grey        | 1        | 200                     |
| <b>40-101TIC</b> | TiC Carbide Coated each - Grey | 1        | 200                     |
| <b>40-101DUR</b> | DuraCoat Coated each           | 1        | 200                     |
| Dimensions       |                                | L 57.3mm | W 19mm T 0.38mm/ 0.43mm |

- Used for plastic slitting and carpet laying tools
- Round cornered
- Long Life TiN, TiCN, TiC & DuraCoat Coatings available
- Suits 18-420 - See pg. 70, 18-410 - See pg. 71

## Square Slotted



### SQUARE CORNERED SLOTTED BLADE

| CODE               | DESCRIPTION                     | BOX QTY  | CTN QTY         |
|--------------------|---------------------------------|----------|-----------------|
| <b>40-150-2</b>    | Box of 100                      | 1        | 50              |
| <b>40-150-2C</b>   | Cryo Treated Box of 100         | 1        | 1               |
| <b>40-150TNC</b>   | TiN Coated each - Gold          | 1        | 200             |
| <b>40-150-4TNC</b> | TiN Coated Dispenser of 10      | 1        | 20              |
| <b>40-150TCN</b>   | TiCN Coated each - Grey         | 1        | 200             |
| <b>40-150BD</b>    | Black Diamond Coated each-Black | 1        | 200             |
| <b>40-150DUR</b>   | DuraCoat Coated each            | 1        | 200             |
| Dimensions         |                                 | L 57.3mm | W 19mm T 0.38mm |

- Used for plastic slitting and other machine applications
- Square cornered
- Long Life TiN, TiCN, Black Diamond & DuraCoat Coatings available



## 60mm Tech

### 60MM TECHNICAL BLADE

| CODE          | DESCRIPTION | BOX QTY | CTN QTY        |
|---------------|-------------|---------|----------------|
| <b>60-20G</b> | Bulk        | 200     | 1000           |
| Dimensions    |             | L 60mm  | W 22mm T 0.2mm |

- Used in plastic slitting machines
- 3 hole, square cornered
- Made in Germany

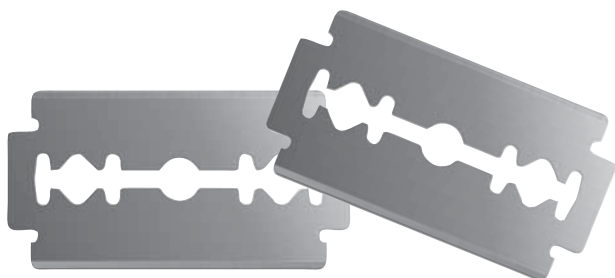

## Sterling® Shaving Blade

| CODE                 | DESCRIPTION | BOX QTY    | CTN QTY               |
|----------------------|-------------|------------|-----------------------|
| <b>04TSS</b>         | Pack of 5   | 20*        | 1000                  |
| *Box quantities only |             | Dimensions | L 43mm W 22mm T 0.1mm |

- Platinum Super Stainless Steel, double sided
- Individually wrapped
- Suits shaving blade holders



## Sterling® Arrow Head

### BLADE

| CODE        | DESCRIPTION | BOX QTY  | CTN QTY           |
|-------------|-------------|----------|-------------------|
| <b>8340</b> | Pack of 10  | 1        | 1000              |
| Dimensions  |             | L 30.6mm | W 24.85mm T 0.5mm |

- Made in Germany



## Perforator Blade

| CODE        | DESCRIPTION | BOX QTY  | CTN QTY        |
|-------------|-------------|----------|----------------|
| <b>8237</b> | Each Bulk   | 1        | 1500           |
| Dimensions  |             | L 33.4mm | W 10mm T 0.2mm |

- Used for plastic slitting
- Ideal for custom perforation
- Made in Germany

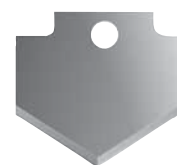

## Sterling® Arrow Head

### BLADE

| CODE        | DESCRIPTION | BOX QTY  | CTN QTY          |
|-------------|-------------|----------|------------------|
| <b>B-39</b> | Tube of 10  | 1        | 50               |
| Dimensions  |             | L 17.7mm | W 19.3mm T 0.4mm |

- B-39 suits TC-11 tube cutter - See pg. 59
- Made in Taiwan



## Round Mica

### ROUND CORNERED MICA KNIFE BLADE

| CODE            | DESCRIPTION | BOX QTY | CTN QTY           |
|-----------------|-------------|---------|-------------------|
| <b>451-040R</b> | Tube of 10  | 1       | 50                |
| Dimensions      |             | L 39mm  | W 18.2mm T 0.40mm |

- Suits #100R Safety Mica Knife - See pg. 46
- 418-1 Protector - See pg. 47

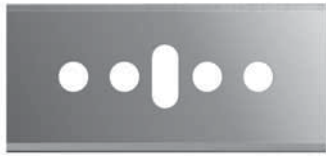

## Square Mica

### SQUARE CORNERED MICA KNIFE BLADE

| CODE           | DESCRIPTION | BOX QTY | CTN QTY           |
|----------------|-------------|---------|-------------------|
| <b>451-040</b> | Tube of 10  | 1       | 50                |
| Dimensions     |             | L 39mm  | W 18.2mm T 0.40mm |

- Suits #100R Safety Mica Knife - See pg. 46
- 418-1 Protector - See pg. 47



## Carton Blade

### ROUND CORNERED CARTON BLADE

| CODE            | DESCRIPTION | BOX QTY | CTN QTY          |
|-----------------|-------------|---------|------------------|
| <b>471-040R</b> | Tube of 10  | 1       | 50               |
| Dimensions      |             | L 39mm  | W 18.2mm T 0.4mm |

- Fits #100B Brass Carton Cutter. See pg. 47



## Poultry Blade

| CODE          | DESCRIPTION                 | BOX QTY | CTN QTY           |
|---------------|-----------------------------|---------|-------------------|
| <b>04-031</b> | Box of 350 Stainless Steel* | 1       | 1                 |
| <b>SM-90</b>  | Box of 100 Carbon Steel**   | 1       | 1                 |
| Dimensions    |                             | L 61mm  | W 12.6mm T 0.65mm |

- Used in Poultry processing machine
- Available in Stainless Steel\* or Carbon Steel\*\*
- Made in Sheffield - England



## Crane Type

### STRIP CUTTER BLADE

| CODE            | DESCRIPTION | BOX QTY  | CTN QTY          |
|-----------------|-------------|----------|------------------|
| <b>40-500-4</b> | Tube of 8   | 1        | 1                |
| Dimensions      |             | L 37.3mm | W 11.5mm T 1.0mm |

- Replacement blade for carpet strip cutters



## Mini Blade

| CODE          | DESCRIPTION | BOX QTY  | CTN QTY          |
|---------------|-------------|----------|------------------|
| <b>03-043</b> | Card of 5   | 20*      | 20               |
| Dimensions    |             | L 28.6mm | W 9.1mm T 0.45mm |

\*Box quantities only

- One hole mini blade
- Suits #110 - Mini Knife. See pg. 14
- Made in USA



**Sterling**

## Fibreglass 1 Hole

### 1 HOLE FIBREGLASS CHOPPER BLADE

| CODE                             | DESCRIPTION        | BOX QTY | CTN QTY |
|----------------------------------|--------------------|---------|---------|
| <b>70-225-2</b>                  | Plastic Box of 100 | 1       | 10      |
| Dimensions L 22mm W 8mm T 0.25mm |                    |         |         |

- 0.875" x 0.312"
- Made in USA
- Suits some Robinson, Glasscraft & other Chopper Guns



**Sterling**

## Fibreglass 2 Hole

### 2 HOLE FIBREGLASS CHOPPER BLADE

| CODE                               | DESCRIPTION        | BOX QTY | CTN QTY |
|------------------------------------|--------------------|---------|---------|
| <b>70-201-2</b>                    | Plastic Box of 100 | 1       | 10      |
| Dimensions L 25.5mm W 8mm T 0.25mm |                    |         |         |

- 1.00" x 0.312"
- Made in USA
- Suits most Fiberglass Chopper Guns



**Sterling** 430B-4

### YELLOWTAIL REPLACEMENT BLADE

| CODE                               | DESCRIPTION | BOX QTY | CTN QTY |
|------------------------------------|-------------|---------|---------|
| <b>430B-4</b>                      | Card of 10  | 1       | 10      |
| Dimensions L 50.3mm W 12mm T 0.4mm |             |         |         |

- Suits Yellowtail Safety Knife. See pg. 43.
- Also suits OLFA SK-7 cutter

Injector Blade



TIN Coated



TiCN Coated



Black Diamond Coated

**Sterling**

### INJECTOR BLADE

| CODE                             | DESCRIPTION             | BOX QTY | CTN QTY |
|----------------------------------|-------------------------|---------|---------|
| <b>70-1102-2</b>                 | Box of 1000             | 1       | -       |
| <b>70-1102-3</b>                 | Dispenser of 20         | 1       | -       |
| <b>70-1102TNC</b>                | TIN Coated each - Gold  | 1       | 200     |
| <b>70-1102TCN</b>                | TiCN Coated each - Grey | 1       | 200     |
| <b>70-1102BD</b>                 | Coated each - Black     | 1       | 200     |
| <b>70-1102TIC</b>                | Carbide coated - Grey   | 1       | 200     |
| Dimensions L 38mm W 8mm T 0.25mm |                         |         |         |

- Stainless Steel
- Made in USA
- Long life TiN, TiCN & Black Diamond Coatings available
- Also suits some Venus fibreglass Chopper Guns

# Clean cut

An exceptional range of **disposal scalpels** and **individually wrapped** professional **sterile scalpel blade** shapes and styles.



Surgical Sharpness



Sterile blades  
individually wrapped



*Sterling*





## Swann Morton Disposable Scalpels

| CODE             | DESCRIPTION         | BOX QTY | CTN QTY |
|------------------|---------------------|---------|---------|
| <b>No. 22DSM</b> | Sterile – Box of 10 | 1       | –       |
| <b>No. 23DSM</b> | Sterile – Box of 10 | 1       | –       |
| <b>No. 24DSM</b> | Sterile – Box of 10 | 1       | –       |

- Blade and handle supplied as complete disposable unit
- Made in Sheffield - England
- Swann Morton brand



## Swann Morton Disposable Scalpels

| CODE             | DESCRIPTION         | BOX QTY | CTN QTY |
|------------------|---------------------|---------|---------|
| <b>No. 11DSM</b> | Sterile – Box of 10 | 1       | –       |
| <b>No. 15DSM</b> | Sterile – Box of 10 | 1       | –       |

- Blade and handle supplied as complete disposable unit
- Made in Sheffield - England
- Swann Morton brand



## Disposable Scalpels

| CODE            | DESCRIPTION         | BOX QTY | CTN QTY |
|-----------------|---------------------|---------|---------|
| <b>No. 10D</b>  | Sterile – Box of 10 | 1       | –       |
| <b>No. 10AD</b> | Sterile – Box of 10 | 1       | –       |
| <b>No. 11D</b>  | Sterile – Box of 10 | 1       | –       |
| <b>No. 12D</b>  | Sterile – Box of 10 | 1       | –       |
| <b>No. 15D</b>  | Sterile – Box of 10 | 1       | –       |

- Blade and handle supplied as complete disposable unit

Scalpel

217

SCALPEL BLADES

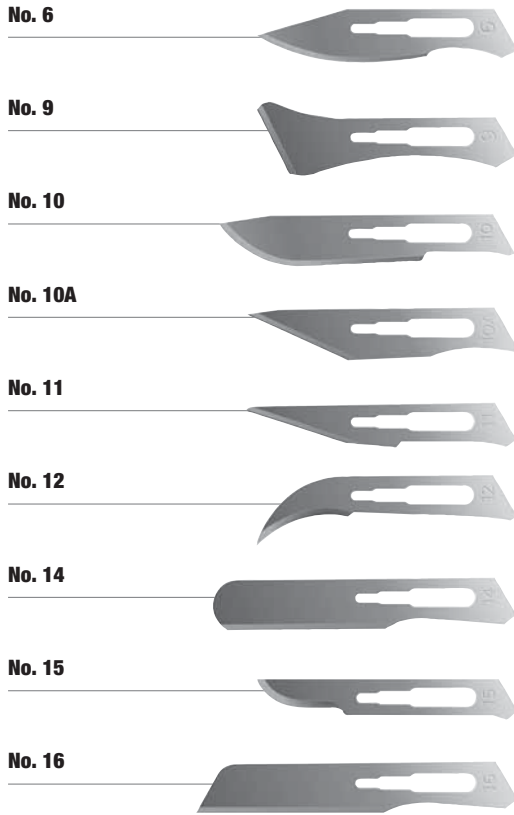

## Scalpel Blades

### NO. 3 FITMENT SCALPEL BLADES

| CODE           | DESCRIPTION          | BOX QTY | CTN QTY |
|----------------|----------------------|---------|---------|
| <b>No. 6</b>   | Sterile – Box of 100 | 1       | –       |
| <b>No. 9</b>   | Sterile – Box of 100 | 1       | –       |
| <b>No. 10</b>  | Sterile – Box of 100 | 1       | –       |
| <b>No. 10A</b> | Sterile – Box of 100 | 1       | –       |
| <b>No. 11</b>  | Sterile – Box of 100 | 1       | –       |
| <b>No. 12</b>  | Sterile – Box of 100 | 1       | –       |
| <b>No. 14</b>  | Sterile – Box of 100 | 1       | –       |
| <b>No. 15</b>  | Sterile – Box of 100 | 1       | –       |
| <b>No. 16</b>  | Sterile – Box of 100 | 1       | –       |

- No.3 Fitment
- Sterile blades individually wrapped
- Suits handles No.3SM & No.3SS, 2800 & 2801 - See pg. 127

## Swann Morton Scalpel Blades

### NO. 3 FITMENT SWANN MORTON SCALPEL BLADES

| CODE             | DESCRIPTION          | BOX QTY | CTN QTY |
|------------------|----------------------|---------|---------|
| <b>No. 6SM</b>   | Sterile – Box of 100 | 1       | –       |
| <b>No. 9SM</b>   | Sterile – Box of 100 | 1       | –       |
| <b>No. 10SM</b>  | Sterile – Box of 100 | 1       | –       |
| <b>No. 10ASM</b> | Sterile – Box of 100 | 1       | –       |
| <b>No. 11SM</b>  | Sterile – Box of 100 | 1       | –       |
| <b>No. 12SM</b>  | Sterile – Box of 100 | 1       | –       |
| <b>No. 14SM</b>  | Sterile – Box of 100 | 1       | –       |
| <b>No. 15SM</b>  | Sterile – Box of 100 | 1       | –       |

- No.3 Fitment
- Made in Sheffield - England
- Swann Morton Brand
- Sterile blades individually wrapped
- Suits handles No.3SM & No.3SS, 2800 & 2801 - See pg. 127



## Scalpel Blades

**NO. 4 FITMENT**

| CODE           | DESCRIPTION          | BOX QTY | CTN QTY |
|----------------|----------------------|---------|---------|
| <b>No. 20</b>  | Sterile – Box of 100 | 1       | –       |
| <b>No. 21</b>  | Sterile – Box of 100 | 1       | –       |
| <b>No. 22</b>  | Sterile – Box of 100 | 1       | –       |
| <b>No. 22A</b> | Sterile – Box of 100 | 1       | –       |
| <b>No. 23</b>  | Sterile – Box of 100 | 1       | –       |
| <b>No. 24</b>  | Sterile – Box of 100 | 1       | –       |
| <b>No. 25</b>  | Sterile – Box of 100 | 1       | –       |
| <b>No. 25A</b> | Sterile – Box of 100 | 1       | –       |
| <b>No. 26</b>  | Sterile – Box of 100 | 1       | –       |

- No.4 Fitment
- Sterile blades individually wrapped
- Suits No. 4SM handle & No 4SS handle - See pg. 127

## Swann Morton Scalpel Blades

**NO. 4 FITMENT**

| CODE             | DESCRIPTION          | BOX QTY | CTN QTY |
|------------------|----------------------|---------|---------|
| <b>No. 20SM</b>  | Sterile – Box of 100 | 1       | –       |
| <b>No. 21SM</b>  | Sterile – Box of 100 | 1       | –       |
| <b>No. 22SM</b>  | Sterile – Box of 100 | 1       | –       |
| <b>No. 22ASM</b> | Sterile – Box of 100 | 1       | –       |
| <b>No. 23SM</b>  | Sterile – Box of 100 | 1       | –       |
| <b>No. 24SM</b>  | Sterile – Box of 100 | 1       | –       |
| <b>No. 25SM</b>  | Sterile – Box of 100 | 1       | –       |
| <b>No. 25ASM</b> | Sterile – Box of 100 | 1       | –       |
| <b>No. 26SM</b>  | Sterile – Box of 100 | 1       | –       |

- No.4 Fitment
- Made in Sheffield - England
- Swann Morton brand
- Sterile blades individually wrapped
- Suits No.4SM handle & No.4SS handle - See pg. 127

Smooth out those rough edges with the **NEW Sterling Deburring tools**. Available in various shapes and sizes, comfort grip, extensions and handles.

Clean getaway





New composite Acetal & Rubber body



Blade storage in rear



Comfort grip with rubber nose area

# Comfort Grip Deburrer



*Sterling*<sup>®</sup>

### COMFORT GRIP DEBURRER - C TYPE

| CODE         | DESCRIPTION                 | BOX QTY | CTN QTY |
|--------------|-----------------------------|---------|---------|
| <b>DT-MK</b> | Black/Yellow Takes C blades | 12      | -       |

- New composite Acetal & Rubber body provides ergonomic comfort grip
- Secure quick-release blade holding system
- Blade storage in rear
- Supplied with C-10, C-20 & C-30 blades

*Sterling*

# deburring

# 221

DEBURRING TOOLS



Comfort Grip Multi-Deburrer



COMFORT GRIP MULTI-BURRER

| CODE            | DESCRIPTION  | BOX QTY | CTN QTY |
|-----------------|--|---------|---------|
| <b>DT-5C-MK</b> | Black/Yellow Takes C Blades with Telescopic Holder | 12      | -       |

- New composite T-SD-MK Acetal & Rubber body
- Telescopic holder takes C type blades
- Unique push-chuck holding system for easy adjustment & replacement
- Comfort grip rubber nose area
- Supplied with C-10, C-20, C-30, C-15 & C-35 blades



Sterling® Single & Double Edge Deburrer

COMFORT GRIP SCRAPER

| CODE          | DESCRIPTION                    | BOX QTY | CTN QTY |
|---------------|--------------------------------|---------|---------|
| <b>V-2-MK</b> | Black/Yellow Double End Scaper | 12      | -       |

- Double ended V-2 blade for scraping - double edge up to 4mm or single edge up to 6.5mm
- New Composite T-SD-MK Acetal & Rubber body
- Unique push-chuck holding system for easy adjustment & replacement
- Takes replaceable V2 blades. *See pg. 226*



Sterling® Sheet/Rib Deburrer

COMFORT GRIP SHEET/RIB DEBURRER

| CODE          | DESCRIPTION                     | BOX QTY | CTN QTY |
|---------------|---------------------------------|---------|---------|
| <b>VDT-MK</b> | Black/Yellow Sheet/Rib Deburrer | 12      | -       |

- Sheet/Rib Deburrer for deburring both sides of sheet or narrow material
- Supplied with replaceable V-4 blade & telescopic handle. *See pg. 226*
- New Composite T-SD-MK Acetal & Rubber body
- Unique push-chuck holding system for easy adjustment & replacement



Sterling® Combo Scraper

COMFORT GRIP COMBO SCRAPER

| CODE            | DESCRIPTION                 | BOX QTY | CTN QTY |
|-----------------|-----------------------------|---------|---------|
| <b>SCR-6-MK</b> | Black/Yellow Detail Scraper | 12      | -       |

- Double ended scraper blade - Triangular & Internal
- New Composite T-SD-MK Acetal & Rubber body
- Unique push-chuck holding system for easy adjustment & replacement
- Takes replacement SCR-6 blade. *See pg. 226*

Double Ended Bit





**Sterling**

## CT-MK Ceramic

### MULTI-FIT DEBURRING TOOL

| CODE         | DESCRIPTION               | BOX QTY | CTN QTY |
|--------------|---------------------------|---------|---------|
| <b>CT-MK</b> | Black/Yellow Ceramic Tool | 12      | -       |

- Ceramic Blade provides safe deburring on plastics, metals & hardened materials
- Supplied with C-1 replaceable Ceramic Blade. *See pg. 226*
- New Composite T-SD-MK Acetal & Rubber body
- Unique push-chuck holding system for easy adjustment & replacement

**Sterling**

## Sheet Deburring Set



### SHEET DEBURRER SET

| CODE           | DESCRIPTION  | BOX QTY | CTN QTY |
|----------------|--|---------|---------|
| <b>SDT-SET</b> | Excellent for deburring one or both edges of sheets / ribs | 1       | -       |

- Width range of 0-12mm
- Sturdy ABS handle with hand protector
- Takes S-12 blades. *See pg. 226*



**Sterling**

## T-SD-MK Comfort Grip Handle

### COMFORT GRIP HANDLE

| CODE           | DESCRIPTION         | BOX QTY | CTN QTY |
|----------------|---------------------|---------|---------|
| <b>T-SD-MK</b> | Black/Yellow Handle | 12      | -       |

- Takes all telescopic holders, *See pg 224*, scrapers & ceramic blade, *See pg 226*
- New Composite T-SD-MK Acetal & Rubber body
- Unique push-chuck holding system for easy adjustment & replacement
- Ball end screw lock provides comfort, control and security
- Used with correct telescopic holder - *See pg 224*, Will take all 'P' and 'C' type blades - *See pg 225*



## Sterling Economy Deburring Tool

### ECONOMY DEBURRING TOOL - C TYPE

| CODE           | DESCRIPTION              | BOX QTY | CTN QTY |
|----------------|--------------------------|---------|---------|
| <b>DT-1-2</b>  | Deburring Tool (Pack 2)  | 2       | 24      |
| <b>DT-1-10</b> | Deburring Tool (Pack 10) | 10      | 100     |

- Swivel Universal C-10 blade
- All metal body with pocket clip
- Non-replaceable blade
- Available in hangable 2 pack or counter 10 pack



**DT-1-10** 10 Pack



## Sterling "C" Econo Tool

### COMFORT GRIP 'C' TYPE HOLDER

| CODE        | DESCRIPTION                  | BOX QTY | CTN QTY |
|-------------|------------------------------|---------|---------|
| <b>ET-2</b> | Black/Yellow with C-10 blade | 12      | -       |

- Compact metal handle deburring tool with soft grip
- Quick clip replaceable C type blade
- Supplied with C-10 blade
- Ball end provides comfort and control
- Takes blades C-10 – C-35, *See pg 225*



## Sterling "P" Econo Tool

### COMFORT GRIP 'P' TYPE HOLDER

| CODE        | DESCRIPTION                 | BOX QTY | CTN QTY |
|-------------|-----------------------------|---------|---------|
| <b>ET-1</b> | Black/Yellow with P-1 blade | 12      | -       |

- Compact metal handle deburring tool with soft grip
- Quick clip replaceable P type blade
- Supplied with P-1 blade
- Ball end provides comfort and control
- Takes blades P1-P3 *See pg 225*



## Sterling® Countersink Handle

### COUNTERSINK HANDLE

| CODE             | DESCRIPTION                     | BOX QTY | CTN QTY |
|------------------|---------------------------------|---------|---------|
| <b>CS HANDLE</b> | Black/Orange Countersink Handle | 6       | -       |

- Countersink handle to take CS-12, CS-20 & CS-30
- New Composite T-SD-MK Acetal & Rubber body
- Unique push-chuck holding system for easy adjustment & replacement

**CS-12**

**CS-20**

**CS-30**

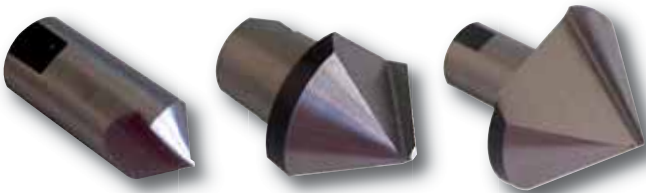

## Sterling® Countersinks

### 2 FLUTE COUNTERSINK

| CODE         | DESCRIPTION      | BOX QTY | CTN QTY |
|--------------|------------------|---------|---------|
| <b>CS-12</b> | 12mm Countersink | 1       | -       |
| <b>CS-20</b> | 20mm Countersink | 1       | -       |
| <b>CS-30</b> | 30mm Countersink | 1       | -       |

- Ideal for hand countersinking applications
- Suits CS Handle



## Sterling® Countersink Holder

### CS-LONG HOLDER FOR COUNTERSINKS

| CODE           | DESCRIPTION             | BOX QTY | CTN QTY |
|----------------|-------------------------|---------|---------|
| <b>CS-LONG</b> | Holder for Countersinks | 1       | -       |

- Holds all 2-Flute Countersinks; CS-12, CS-20, CS-30
- Suits T-SD-MK Handle



## Sterling® C Blade Holder

### C TELESCOPIC BLADE HOLDER

| CODE        | DESCRIPTION               | BOX QTY | CTN QTY |
|-------------|---------------------------|---------|---------|
| <b>DT-C</b> | Takes all C styles blades | 1       | -       |

- Holds all standard 'C' (3.2mm) style blades C-10 – C-35. *See pg. 225*
- Suits T-SD-MK Holder *See pg 223*



## Sterling® P Blade Holder

### P TELESCOPIC BLADE HOLDER

| CODE        | DESCRIPTION              | BOX QTY | CTN QTY |
|-------------|--------------------------|---------|---------|
| <b>DT-P</b> | Takes all P Style blades | 1       | -       |

- Holds all light duty 'P' (2.6mm) style blades P-1, P-2 & P-3. *See pg. 225*
- Suits T-SD-MK Holder *See pg 223*



## Sterling® VT Blade Holder

### VT TELESCOPIC BLADE HOLDER

| CODE      | DESCRIPTION      | BOX QTY | CTN QTY |
|-----------|------------------|---------|---------|
| <b>VT</b> | Takes V-4 blades | 1       | -       |

- Holds V-4 4 way blade. *See pg. 226*
- Suits T-SD-MK Holder *See pg 223*



## Sterling® KW Blade Holder











### KW TELESCOPIC BLADE HOLDER

| CODE      | DESCRIPTION                      | BOX QTY | CTN QTY |
|-----------|----------------------------------|---------|---------|
| <b>KW</b> | Takes all keyway and slot blades | 1       | -       |

- Holds all keyway KW-9, KW-16 and slot blades S-12. *See pg. 226*
- Suits T-SD-MK Holder *See pg 223*



## Sterling® Deburring Blades

| CODE  | DESCRIPTION  | BOX QTY | CTN QTY |
|---|--|---------|---------|
|    | <b>LIGHT DUTY 2.6MM SWIVEL BLADE</b><br><b>P-1</b> For light duty and small components<br>Ideal for steel, aluminium, copper, zinc, plastics etc | 10      | 100     |
|    | <b>LIGHT DUTY 2.6MM SWIVEL BLADE</b><br><b>P-2</b> For small components<br>Ideal for cast iron and brass   | 10      | 100     |
|   | <b>LIGHT DUTY 2.6MM SWIVEL BLADE</b><br><b>P-3</b> For deburring both sides of sheetmetal holes up to 6mm thick                                  | 10      | 100     |
|  | <b>STANDARD 3.2MM SWIVEL BLADE</b><br><b>C-10</b> Ideal for steel, aluminium, copper, zinc, plastics etc.  | 10      | 100     |
|  | <b>STANDARD 3.2MM SWIVEL BLADE</b><br><b>C-15</b> Ideal for stainless steel and hard plastics  | 10      | 100     |
|  | <b>STANDARD 3.2MM SWIVEL BLADE</b><br><b>C-20</b> Ideal for materials with brittle burr i.e. cast iron and brass                                 | 10      | 100     |
|  | <b>STANDARD 3.2MM SWIVEL BLADE</b><br><b>C-30</b> Ideal for simultaneous deburring of inner and outer edges of sheetmetal up to 10mm thickness   | 10      | 100     |
|  | <b>STANDARD 3.2MM SWIVEL BLADE</b><br><b>C-60</b> Ideal for all backside edge deburring up to 20mm thickness                                     | 5       | 100     |
|  | <b>SMALL HEAD 3.2MM SWIVEL BLADE</b><br><b>C-101</b> Ideal for small holes from 1.5mm in steel and aluminium                                     | 10      | 100     |
|  | <b>STANDARD 3.2MM SWIVEL BLADE</b><br><b>C-35</b> Ideal for straight edges on most materials   | 10      | 100     |



## Sterling® Keyway

### 9MM KEYWAY DEBURRING BLADE

| CODE        | DESCRIPTION     | BOX QTY | CTN QTY |
|-------------|-----------------|---------|---------|
| <b>KW-9</b> | For width 0-9mm | 1       | -       |

- 4 cutting edges (2 for standard depth and 2 for shallow depth)
- Suits stainless steel
- Use with KW holder. *See pg. 224*

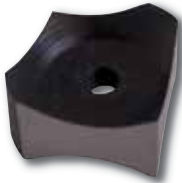

## Sterling® Keyway

### 16MM KEYWAY DEBURRING BLADE

| CODE         | DESCRIPTION      | BOX QTY | CTN QTY |
|--------------|------------------|---------|---------|
| <b>KW-16</b> | For width 0-16mm | 1       | -       |

- 4 Cutting edges (2 for standard depth and 2 for shallow depth)
- Suits stainless steel
- Use with KW holder. *See pg. 224*



## Sterling® Sheet/Rib

### SHEET / RIB DEBURRING BLADES

| CODE        | DESCRIPTION  | BOX QTY | CTN QTY |
|-------------|--|---------|---------|
| <b>S-12</b> | Cutting edge along full circle and 2 sides for long life | 1       | -       |

- Use with SDT-SET, *See pg. 223* or KW holder, *See pg. 224* - 2 blades in set



## Sterling® 4 Way

### 4 WAY DEBURRING BLADE

| CODE       | DESCRIPTION   | BOX QTY | CTN QTY |
|------------|---|---------|---------|
| <b>V-4</b> | 4V shape edges (2 for 1-12mm width and 2 for 0-4mm width) | 1       | -       |

- Use with VT holder. *See pg. 224*
- Replacement blade for VDT-MK. *See pg. 222*



## Double Ended

### V-2 DOUBLE ENDED BLADE

| CODE       | DESCRIPTION        | BOX QTY | CTN QTY |
|------------|--------------------|---------|---------|
| <b>V-2</b> | Double Ended Blade | 10      | -       |

- Deburr up to 4mm width of sheet/Rib material with one end or single edge deburring with other end
- Suits V-2-MK, *See pg. 222*, T-SD-MK holders. *See pg. 223*



## Combo Scraper

### COMBO SCRAPER BLADE

| CODE         | DESCRIPTION         | BOX QTY | CTN QTY |
|--------------|---------------------|---------|---------|
| <b>SCR-6</b> | Combo Scraper Blade | 10      | -       |

- Printed scraper at one end and internal scraper at other end
- Suits SCR-6-MK, *See pg. 222* & T-SD-MK holders. *See pg. 223*



## Ceramic Blade

### C-1 CERAMIC BLADE

| CODE       | DESCRIPTION   | BOX QTY | CTN QTY |
|------------|---------------|---------|---------|
| <b>C-1</b> | Ceramic Blade | 10      | -       |

- Ceramic blade for safe deburring in a wide range of materials including plastics, metals & hardened materials
- Suits CT-MK, *See pg. 223* & T-SD-MK holders. *See pg. 223*



# 14 Piece Deburring Set



## 14 PIECE DEBURRING SET

| CODE | DESCRIPTION | BOX QTY | CTN QTY |
|------|-------------|---------|---------|
|------|-------------|---------|---------|

- |               |   |   |   |
|---------------|---|---|---|
| <b>DTK-14</b> | <b>Set includes:</b>  | 1 | - |
|               | <ul style="list-style-type: none"> <li>• T-SD-MK Handle</li> <li>• DT-C &amp; DT-P Telescopic Blade Holder</li> <li>• CS-LONG Countersink Holder</li> <li>• CS-20 Countersink</li> </ul>          |   |   |
|               | <b>Deburring blades:</b>  |   |   |
|               | <ul style="list-style-type: none"> <li>• C-10</li> <li>• C-20</li> <li>• C-30</li> <li>• C-15</li> <li>• C-35</li> <li>• P1</li> <li>• P2</li> <li>• P3</li> <li>• SCR-6 Combo Scraper</li> </ul> |   |   |

# 24 Piece Deburring Set



## 24 PIECE DEBURRING SET

| CODE | DESCRIPTION | BOX QTY | CTN QTY |
|------|-------------|---------|---------|
|------|-------------|---------|---------|

- |               |   |   |   |
|---------------|---|---|---|
| <b>DTK-24</b> | <b>Set includes:</b>  | 1 | - |
|               | <ul style="list-style-type: none"> <li>• T-SD-MK Handle</li> <li>• ET-1 &amp; ET-2 Econohandles</li> <li>• DT-C &amp; DT-P Telescopic Blade Holder</li> <li>• CS-LONG Countersink Holder</li> <li>• CS-20 Countersink</li> <li>• KW Blade Holder</li> </ul>                                   |   |   |
|               | <b>Deburring blades:</b>  |   |   |
|               | <ul style="list-style-type: none"> <li>• C-10 (x3)</li> <li>• C-20</li> <li>• C-30</li> <li>• C-15</li> <li>• C-35</li> <li>• C-101</li> <li>• P1, P2 &amp; P3</li> <li>• KW-9 &amp; KW-16</li> <li>• SCR-6 Combo Scraper</li> <li>• V-2 Double Ended</li> <li>• C-1 Ceramic Blade</li> </ul> |   |   |



Whether you just have a corner or a large warehouse space,  
**there's a Sterling stand to cater for your display needs.**  
But why stop at one - a combination of sizes could suit you better.  
**So go on - show off!**

SHOW OFF

*Sterling*

# Sterling Large Stand



**Sterling**

## STERLING LARGE DISPLAY STAND ONE

| CODE            | DESCRIPTION                         |
|-----------------|-------------------------------------|
| <b>LGSTER01</b> | Large Sterling Display 1            |
| Size            | 2100mm (H) x 1250mm (W) x 500mm (D) |

- Outstanding presentation of Sterling range
- Standard options available
- Fully customisable to suit your showroom

displays 229

STERLING DISPLAYS

## Sterling Spinner Stand



Sterling®

**STERLING SPINNER DISPLAY STAND**

| CODE              | DESCRIPTION                    | BOX QTY                | CTN QTY |
|-------------------|--------------------------------|------------------------|---------|
| <b>STERSPINHD</b> | Sterling Spinner Display Stand | ea                     | ea      |
|                   | Dimensions                     | 1750mm (H) x 440mm (W) |         |

- Compact display that holds an excellent range
- Can be positioned anywhere in your showroom
- Standard options available
- Fully customisable to suit your showroom

## Sterling Small Floor Stand



Sterling®

**SMALL FLOOR DISPLAY STAND**

| CODE            | DESCRIPTION               | BOX QTY                            | CTN QTY |
|-----------------|---------------------------|------------------------------------|---------|
| <b>SMSTER01</b> | Small Floor Display Stand | ea                                 | ea      |
|                 | Dimensions                | 1460mm (H) x 700mm (W) x 500mm (D) |         |

- Compact display holds a concise Sterling range
- Ideal for smaller showroom areas
- Standard options available
- Fully customisable to suit your showroom

Sterling Double Stand



**STERLING DOUBLE LARGE DISPLAY STAND**

| CODE            | DESCRIPTION              | BOX QTY                             | CTN QTY |
|-----------------|--------------------------|-------------------------------------|---------|
| <b>LGSTER02</b> | Large Sterling Display 1 | ea                                  | ea      |
|                 | Dimensions               | 2100mm (H) x 2500mm (W) x 500mm (D) |         |

- Awesome presentation of complete Sterling range
- Ideal for Trade & Industrial Suppliers
- Standard options available
- Fully customisable to suit your showroom

| Stock Code    | Description   | Page No.   |
|---------------|---|------------|
| <b>01-092</b> | <b>Swivel Art Knife Blade (x2)</b>                  | <b>126</b> |
| 01-101-2      | No. 10 Craft Blade (x100)                           | 202        |
| 01-103-1      | No. 10 Craft Blade (x5)                             | 202        |
| 01-111-2      | No. 11 Craft Blade (x100)                           | 201        |
| 01-113-2      | No. 11 Craft Blade (x100) UK                        | 202        |
| 01-161-2      | No. 16 Craft Blade (x100)                           | 202        |
| 01-163-1      | No. 16 Craft Blade (x5)                             | 202        |
| 01-173-1      | No.17 Hobby Blade (x5)                              | 202        |
| 01-181-2      | No. 18 Craft Blade (x100)                           | 202        |
| 01-183-1      | No.18 Hobby Blade (x5)                              | 202        |
| 01-191-2      | No.19 Hobby Blade (x100)                            | 203        |
| 01-192-2      | No.19 Single Bevel Matt Blade (x100)                | 203        |
| 01-201-2      | STERLING No. 2 Craft Blade (x100)                   | 203        |
| 01-203-1      | STERLING No.2 Craft Blade (x5)                      | 203        |
| 01-231-2      | No.23 Hobby Blade (x100)                            | 203        |
| 01-231TNC     | No. 23 Craft Blade - Titanium                       | 203        |
| 01005-1       | 18mm Large Snap Blade Card 5                        | 186        |
| 02005-1       | 9mm Small Snap Blade Card 5                         | 191        |
| 03-0016       | Floor Dot 8in Extendable Floor Scraper              | 81         |
| 03-018        | Extra Heavy Duty SS Trimming Knife Blade (x100)     | 176        |
| 03-043        | Mini Trimming Blade with Holes Card (x5)            | 214        |
| 03-096        | Long Heavy Duty Blade (X5)                          | 179        |
| 03-153        | Linoleum Blade Card 1                               | 183        |
| 04-0140       | F1 Floor Dot Premium Knee Kicker                    | 79         |
| 04-0140-1     | Pin Plate for F1 Knee Kicker                        | 80         |
| 04-0140-4     | 2in Bumper for Floor Dot Knee Kickers               | 80         |
| 04-0140-5     | 3in Bumper for Floor Dot Knee Kickers               | 80         |
| 04-0150-1     | Pin Plate for 04-0160 Knee Kicker                   | 80         |
| 04-0150-2     | Grippers Cottonhead Type for Knee Kickers (x3)      | 80         |
| 04-0160       | Floor Dot Hi Arch Knee Kicker                       | 79         |
| 04-0161       | Cover for 04-0160 Knee Kicker                       | 80         |
| 04-0270       | Floor Dot 4in Seam Roller                           | 82         |
| 04-0290       | Floor Dot Carpet Tucker Roller                      | 81         |
| 04-0291       | Replacement Wheels (x2) for Floor Dot Carpet Tucker | 81         |
| 04-031        | Poultry Blade (x350) - Stainless Steel              | 214        |
| 04-0499       | Floor Dot Red Row Cutter                            | 83         |
| 04-0500       | Floor Dot Cushion Back Cutter                       | 83         |
| 04-0505       | Floor Dot Loop Pile Cutter                          | 82         |
| 04-0510       | Floor Dot Wall Trimmer                              | 82         |
| 04-0608       | Floor Dot 8in Offset Napping Shears                 | 83         |
| 04-0612       | Floor Dot 10in Carpet Shear                         | 83         |
| 04-0670       | Floor Dot Nail Driving Bar                          | 84         |
| 04-0680       | Floor Dot Moulding Lifter                           | 84         |
| 04-3003       | Floor Dot Heavy Duty Blades (x100)                  | 176        |
| 04-3027       | Floor Dot 4in Scraper Blades (x10)                  | 196        |
| 04-3032-1     | Floor Dot 8in Scraper Blades (x10)                  | 197        |
| 04-3050       | Floor Dot 18mm Large Snap off Blades (x10)          | 187        |
| 04-3055       | Floor Dot 18mm Black Snap off Blades (x10)          | 187        |
| 04TSS         | Platinum Stainless shaving blades (x5)              | 213        |
| 05-0010       | Floor Dot PVC & Lino Groover                        | 84         |
| 05-0011       | Floor Dot Groover Replacement Blades (x5)           | 85         |
| 05-0080       | Floor Dot Multi Scriber                             | 85         |
| 05-0091-1     | Diamond Exacto Blades (x2)                          | 85         |
| 05-0091-2     | Flat Exacto Blades (x2)                             | 85         |
| 05-0091-3     | Small Round Exacto Blades (x2)                      | 85         |
| 05-0091-4     | Large Round Exacto Blades (x2)                      | 85         |
| 05-491        | Single Edge Razor Blade #9 (x100)                   | 193        |
| <b>100</b>    | <b>Silver Metal Carton Opener</b>                   | <b>47</b>  |
| 10021         | 1000mm/40in Stainless Steel Ruler - Metric/Imperial | 137        |
| 100B          | Carton Cutter                                       | 47         |
| 100R          | Auto Retracting Carton Cutter                       | 46         |
| 102-1         | Ultra-Lap Silver Fixed Knife - Carded               | 20         |
| 102-1S        | Ultra-Lap Silver Fixed Knife w/Thumblock - Carded   | 20         |
| 102-2         | Ultra-Lap Silver Fixed Knife                        | 20         |
| 102-2B        | Ultra-Lap Silver Fixed Knife w/3 Blades             | 20         |

| Stock Code | Description  | Page No. |
|------------|--|----------|
| 102-2R     | Ringlock Fixed Trimming Knife                        | 20       |
| 102-2RD    | Ringlock Fluro Fixed Trimming Knife                  | 20       |
| 102-2S     | Ultra-Lap Silver Fixed Knife w/Thumblock             | 20       |
| 104-063    | Hooked Blade with Centre Hole (x10)                  | 181      |
| 104-1      | Lockset Fixed Trimming Knife                         | 20       |
| 105-063    | Deep Hooked Blade (x10)                              | 181      |
| 105-2      | Silver Shark Fixed Knife                             | 19       |
| 106-2      | Green Quick Change Fixed Knife                       | 21       |
| 107-2      | Hard Edge Fixed Blade Trimming knife                 | 21       |
| 1089       | 10m x 25mm Tape Measure - TapeTech                   | 145      |
| 1089I      | 10m/33ft Tape Measure - TapeTech                     | 145      |
| 109-1      | Swivel Lock Fixed Blade Knife                        | 21       |
| 110 MINI   | Mini Retractable Knife                               | 14       |
| 1105       | Universal Shears with Orange Handle                  | 103      |
| 1105A      | Replacement Anvil for 1105 Shears                    | 103      |
| 1105B      | Replacement Blade for 1105 Shears                    | 103      |
| 111-1      | No. 11 Craft Blade (x5)                              | 201      |
| 112-1      | Auto-Loading Retractable Knife                       | 11       |
| 112COMBO   | 112 Knife Combo Pack with Holster and Blade Pack     | 11       |
| 114-1      | Yellow/Black Retractable Knife                       | 13       |
| 114-2R     | Auto-Retracting Orange Safety Knife with Rubber Grip | 40       |
| 114-2RS    | Auto-Retracting Knife with Thumb-Screw               | 40       |
| 115-1G     | Ultra Grip Retractable Grey Knife                    | 12       |
| 115-1GS    | Ultra Grip Retractable Knife + Thumscrew             | 13       |
| 115-1Y     | Ultra Grip Retractable Yellow Knife                  | 12       |
| 115-1YR    | Orange Safety Auto-Retracting Knife                  | 40       |
| 115-1YRS   | Orange Ultra Grip Safety Knife + Thumblock           | 39       |
| 115-1YS    | Retractable Yellow Knife + Thumblock                 | 13       |
| 115-2BG    | Ultra Grip Retractable Grey Knife                    | 12       |
| 115-2BY    | Ultra Grip Retractable Yellow Knife                  | 12       |
| 115-2G     | Ultra Grip Retractable Grey Knife                    | 12       |
| 115-2GS    | Retractable Grey Knife + Thumscrew                   | 13       |
| 115-2Y     | Ultra Grip Retractable Yellow Knife                  | 12       |
| 115-2YS    | Retractable Yellow Knife + ThumScrew                 | 13       |
| 117-2      | Fast-Lock Retractable Knife with Holster             | 13       |
| 118-2      | Yellow/Black Rhino Grip Retractable Knife            | 13       |
| 119-1      | Retractable Trimming Knife                           | 14       |
| 119-1R     | Safety Auto-Retracting Knife                         | 40       |
| 119-2      | Retractable Grey Trimming Knife                      | 14       |
| 119-2D     | Fluro Retractable Trimming Knife                     | 14       |
| 119-2S     | Retractable Grey Knife + ThumScrew                   | 14       |
| 1200D      | Mat Cutter Blade - 0.12 Double (x5)                  | 209      |
| 1200S      | Mat Cutter Blade - 0.12 Single (x5)                  | 209      |
| 12021-A    | 1200mm Aluminium Rule                                | 138      |
| 12021-AR   | 1200mm Aluminium Rule + Rubber Back                  | 138      |
| 1241       | No.1 Craft Tool Blade (x50)                          | 203      |
| 1242       | No.2 Craft Tool Blade (x50)                          | 203      |
| 1243       | No.3 Craft Tool Blade (x50)                          | 203      |
| 128        | Yellow 9mm Plastic Cutter                            | 36       |
| 13-2202-2  | Dexter Blade (x100)                                  | 205      |
| 14-010     | 4x12in Heavy Duty Scraper                            | 93       |
| 14-012     | 4x12in Heavy Duty Scraper with Hammer End            | 93       |
| 14-030     | 4x18in Heavy Duty Scraper                            | 93       |
| 14-048     | 4x48in Heavy Duty Scraper                            | 93       |
| 14-084     | 6 x 24in Heavy Duty Scraper                          | 94       |
| 14-086     | 8in Telescopic Scraper                               | 94       |
| 14-088     | 5in x17in Heavy Duty Scraper                         | 94       |
| 14-132     | Lino Knife with Rubber Handle                        | 68       |
| 14-134     | Carpet Knife   | 69       |
| 14-137     | Carpet Tucking Knife                                 | 67       |
| 14-708     | Long Handle Scraper                                  | 89       |
| 1402-4     | Sharp Angle 9mm Snap-Off Blade (x10)                 | 190      |
| 1403-S     | 9mm Small Snap-Off Blade (x10)                       | 191      |
| 1404-L     | Large 18mm Snap Blade (x10)                          | 186      |
| 1404L-1    | Large 18mm Snap Blade (x10) Carded                   | 186      |
| 1404L-2    | Large 18mm Snap Blade (x50)                          | 186      |



| Stock Code   | Description   | Page No.   |
|--------------|---|------------|
| 1500D        | Mat Cutter Blade - 0.15 Double (x5)                     | 209        |
| 1500S        | Mat Cutter Blade - 0.15 Single (x5)                     | 209        |
| 15021        | 1500mm/60in Stainless Steel Ruler - Metric/Imperial     | 137        |
| 15021-A      | 1500mm Aluminium Rule                                   | 138        |
| 15021-AR     | 1500mm Aluminium Rule with rubber back                  | 138        |
| 1521         | 150mm/6in Stainless Steel Ruler - Metric/Imperial       | 137        |
| 16           | Yellow Touch Knife                                      | 46         |
| 160-063      | Long Beak Concave Trimming Blade (x10)                  | 182        |
| 16003        | BOA Plastic Handle Versasaw                             | 62         |
| 16004        | BOA Aluminium Versa Hacksaw                             | 63         |
| 17-635       | Economy Notched Trowel 1.6 and 2.4                      | 77         |
| 17-H1        | Slidlock Trowel Handle - Small                          | 75         |
| 17-H2        | Slidlock Trowel Handle - Large                          | 75         |
| 17-SQ1       | 1.6mm Slidlock Blade - Square Notch                     | 77         |
| 17-ST        | Slidlock Blade - Straight                               | 77         |
| 17-U1        | Slidlock Trowel Blade 0.8mm U1                          | 77         |
| 17-VN1       | Slidlock Trowel Blades - 1.6mm V                        | 77         |
| 17-VN2       | Slidlock Trowel Blade - 2.4mm V                         | 77         |
| 17-VN3       | Slidlock Trowel Blade - 3.2mm V                         | 77         |
| 17-VN5       | Slidlock Trowel Blade - 4.8mm V                         | 77         |
| 17-VN6       | Slidlock Trowel Blade - 6.0mm V                         | 77         |
| 18-001       | Blue Carpet Foam Back Cutter                            | 70         |
| 18-002       | Red Carpet Row Cutter                                   | 70         |
| 18-010       | 100mm Smooth Seam Roller                                | 72         |
| 18-020       | 150mm Smooth Seam Roller                                | 71         |
| 18-030       | 100mm Flex Action Seam Roller                           | 71         |
| 18-040       | 100mm Seam Roller                                       | 71         |
| 18-050       | 150mm Seam Roller                                       | 71         |
| 18-070       | Wall Trimmer  | 70         |
| 18-070WR     | Nylon Wall Runner                                       | 70         |
| 18-092       | Cushion Grip Stair Tool                                 | 69         |
| 18-095       | T-Type Stair Tool                                       | 69         |
| 18-410       | Loop Pile Cutter  | 71         |
| 18-420       | Cushion Back Cutter                                     | 70         |
| 18-501       | Knee Pad  | 73         |
| 18-530       | Gel Knee Pads   | 73         |
| 18-540       | Knee Pad with Replaceable Caps                          | 73         |
| 18-550       | Non Marking Comfort Style Knee Pad                      | 72         |
| 19015        | Ruler/Cutter & Green Cutting Mat                        | 133        |
| 1910         | 4in Window Scraper                                      | 91         |
| 1915         | 6in ErgoScrape Rubber Grip Scraper                      | 90         |
| 1916         | 6in Triumph Angled MK-3 Scraper                         | 90         |
| 1917         | 6in Triumph Mk2 Black Plastic Scraper                   | 90         |
| 1918         | 5in Champion Scraper                                    | 90         |
| 1919         | 80mm Blue Plastic Handy Scraper                         | 91         |
| 1B           | Allway Scraper Blade 28mm (X2)                          | 98         |
| <b>200-1</b> | <b>STERLING 9mm Small Snap-Off Blade (x10) - carded</b> | <b>190</b> |
| 200-2        | STERLING 9mm Small Snap-Off Blade (x50)                 | 190        |
| 200-2S       | STERLING 9mm SS Small Snap-Off Blade (x50)              | 190        |
| 200-4        | STERLING 9mm Small Snap-Off Blade (x10)                 | 190        |
| 200-4S       | STERLING 9mm SS Small Snap-Off Blade (x10)              | 190        |
| 20010        | 245mm Smartcut Rubberised Scissors                      | 121        |
| 20021        | 2000mm/80in Stainless Steel Ruler - Metric/Imperial     | 137        |
| 20021-A      | 2000mm Aluminium Rule                                   | 138        |
| 20021-AR     | 2000mm Aluminium Ruler w/Rubber Back                    | 138        |
| 2005         | 140mm Smartcut Rubberised Scissors                      | 121        |
| 2006         | 155mm Smartcut Rubberised Scissors                      | 121        |
| 2007         | 175mm Smartcut Rubberised Scissors                      | 121        |
| 2008         | 195mm Smartcut Rubberised Scissors                      | 121        |
| 2009         | 215mm Smartcut Rubberised Scissors                      | 121        |
| 201-1        | STERLING 18mm Large Snap Blade (x10) - carded           | 185        |
| 201-2        | STERLING 18mm Large Snap - Off Blade (x50)              | 185        |
| 201-2BH      | Sterling Ultra Black 18mm Snap off Blades (x50)         | 186        |
| 201-2GR      | STERLING ULTRA 18mm Large Snap Blades (x50)             | 186        |
| 201-4        | STERLING 18mm Large Snap - Off Blade (x10)              | 185        |
| 201-4BH      | Sterling Ultra-Black Blades (x10)                       | 186        |
| 201-4GR      | STERLING ULTRA 18mm Large Snap Blade (x10)              | 186        |
| 202-4        | 9mm Small Non Segmented Blade (x10)                     | 191        |
| 203-4        | STERLING 18mm Large Non-Segmented Blade (x10)           | 187        |
| 207-1        | STERLING 25mm X-Large Snap Blades (x10) Sheffield       | 188        |
| 207-2        | STERLING 25mm X-Large Snap Blades (x25) Sheffield       | 188        |
| 208          | Yellow Plastic Scraper                                  | 88         |
| 208B         | Blue Plastic Scraper                                    | 88         |
| 209-2        | STERLING 25mm Non-Segmented Blade (x25)                 | 188        |
| 209-4        | STERLING 25mm Non-Segmented Blade (x10)                 | 188        |
| 210-4        | 12mm STERLING Non Segmented Blades (x10)                | 56         |

| Stock Code    | Description  | Page No.   |
|---------------|--|------------|
| 215-4         | 18mm Hooked Snap Blade (x10)                           | 188        |
| 220-1         | Black Enamelled Steel Cutter                           | 36         |
| 2202-1        | Dexter Blade (x5) - carded                             | 205        |
| 22B           | Allway Scraper Blade 38mm (x2)                         | 98         |
| 26005         | Heavy Duty Blade FCI (x5) - carded                     | 176        |
| 26010         | Heavy Duty Blades Disp.10 Sterling e                   | 176        |
| 26100         | Sterlinge Heavy DutyTrade Blades Disp. 100             | 176        |
| 2800          | Retractaway Scalpel Handle No.3                        | 127        |
| 2801          | Retractaway Carded Scalpel Handle No.3                 | 127        |
| 289           | 2M Tape Measure - TapeTech                             | 145        |
| 29-501        | 135mm Black Panther Stationery Scissors                | 115        |
| 29-503        | 140mm Black Panther Electrical Scissors                | 108        |
| 29-506        | 120mm Black Panther Straight Embroidery Scissors       | 119        |
| 29-507        | 120mm Black Panther Curved Embroidery Scissors         | 119        |
| 29-603        | 160mm Black Panther Stationery Scissors                | 115        |
| 29-700        | 200mm Black Panther Industrial Snips                   | 108        |
| 29-701        | 185mm Black Panther Industrial Snips                   | 107        |
| 29-702        | 185mm Black Panther Red Hi Tensile Industrial Snips    | 108        |
| 29-703        | 185mm Industrial Snips - FCI                           | 109        |
| 29-704        | Black Panther Snips with Round Points                  | 107        |
| 29-707        | 7in. Jewellers Snips                                   | 109        |
| 29-708        | 8in. Traditional Tin Snips                             | 109        |
| 29-710        | 10in. Traditional Tin Snips                            | 109        |
| 29-712        | 12in. Traditional Tin Snips                            | 109        |
| 29-714        | 14in. Traditional Tin Snips                            | 109        |
| 29-740B       | 7in Black Plastic Anvil Magic Snip                     | 105        |
| 29-740Y       | 7in Yellow Plastic Anvil Magic Snip                    | 105        |
| 29-751        | Red Left Cut Aviation Snips                            | 110        |
| 29-752        | Green Right Cut Aviation Snips                         | 110        |
| 29-753        | Yellow Straight Cut Aviation Snips                     | 110        |
| 29-756        | Yellow Long Cut Aviation Snips                         | 110        |
| 29-765        | Red Left Cut Offset Snips                              | 111        |
| 29-766        | Green Right Cut Offset Snips                           | 111        |
| 29-772        | 12in. Pelican Tin Snips                                | 109        |
| 29-775        | Red Left Cut Upright Snips                             | 111        |
| 29-776        | Green Right Cut Upright Snips                          | 111        |
| 29-800        | 210mm Black Panther Scissors                           | 115        |
| 29-802        | 205mm Black Panther Kitchen Scissors                   | 114        |
| 29-810        | 220mm Black Panther Scissors                           | 114        |
| 29-900        | 235mm Black Panther Scissors                           | 115        |
| 29-902        | 250mm Black Panther Scissors                           | 114        |
| 29-904        | 10in Black Panther Carpet Shears                       | 116        |
| 29-910        | 245mm Black Panther Scissors                           | 114        |
| 29-911        | 11in Black Panther Scissors                            | 113        |
| 29-912        | 12in Black Panther Scissor                             | 113        |
| 29-915        | 11in Black Panther Serrated Scissors                   | 113        |
| 29-916        | 12in Black Panther Serrated Scissors                   | 113        |
| 291-1         | Single Edge Razor Blade (x5) carded                    | 194        |
| <b>30-101</b> | <b>Single Edged Razor Blade (x5)</b>                   | <b>194</b> |
| 30-112        | Sterling Single Edge Blades (x100)                     | 193        |
| 30-112CL      | Sterling Single Edge Blades (x100)                     | 193        |
| 30-117        | H/Duty .012 Single Edge Blades (x100)                  | 194        |
| 30-327        | Single Edge No Notch Blades (x100)                     | 194        |
| 300-18S       | 18tpi Hacksaw Blades - Sterling                        | 172        |
| 300-18U       | 18tpi Hacksaw Blade - ULTRA                            | 172        |
| 300-24S       | 24tpi Hacksaw Blades - Sterling                        | 172        |
| 300-24U       | 24tpi Hacksaw Blade - ULTRA                            | 172        |
| 300-32S       | 32tpi Hacksaw Blades - Sterling                        | 172        |
| 300-32U       | 32tpi Hacksaw Blade - ULTRA                            | 172        |
| 300-VARU      | Hacksaw Blade - Variable Tooth 20-24tpi ULTRA Supercut | 171        |
| 30007         | 178mm (7in) Sterling SMARTCHOICE Scissors              | 122        |
| 30008         | 203mm (8in) Sterling SMARTCHOICE Scissors              | 122        |
| 30009         | 229mm (9in) Sterling SMARTCHOICE Scissors              | 122        |
| 3005S         | Stainless Steel Pocket Knife                           | 58         |
| 3021          | 300mm/12in Stainless Steel Ruler - Metric/Imperial     | 137        |
| 3021-M        | 300mm Stainless Steel Ruler - Metric Only              | 137        |
| 3022          | Redneck Folding Knife                                  | 16         |
| 3035          | SportsPro Multi Knife                                  | 16         |
| 3038          | Sterling Stealth Autoloading Sliding Pocket Knife      | 15         |
| 3044          | 4in Stainless Steel Pocket Knife                       | 53         |
| 3056          | MultiPro 12 Function Multitool + Holster               | 58         |
| 30607         | #7 Pounce Wheel  | 129        |
| 3066          | 8 Function Pocket Knife                                | 58         |
| 3088          | Black Folding Pocket Knife                             | 57         |
| 3088B         | Pocket Knife Replacement Blade (x1)                    | 205        |
| 3099          | Riggers Knife  | 59         |



| Stock Code    | Description  | Page No.   | Stock Code       | Description  | Page No.   |
|---------------|--|------------|------------------|--|------------|
| 3104A         | Replacement Anvil for 3104N                                | 104        | 416-L            | Longreach Lefthanded Self Retracting Knife               | 42         |
| 3104B         | Replacement Blades for 3104N                               | 104        | 416B-4           | Longreach Replacement Blades (x10)                       | 189        |
| 3104N         | Green Handle Duck Bill Shears                              | 104        | 417-1            | Safety DOUBLE PLUS Self Retracting Knife                 | 40         |
| 3106          | Heavy Duty Swivel Base Mitre Shear                         | 104        | 418-1            | Protector Fixed Knife with Safety Pin                    | 47         |
| 3108          | Multi-Function Ratchet Shear with 5 Anvils                 | 104        | 420-4            | Technical 3 Hole Blade (x10)                             | 211        |
| 3108A         | Replacement Anvil for 3108                                 | 104        | 420TNC           | Tech 3 Hole Blade RC TiN Coated                          | 211        |
| 3108B         | Replacement Blade for 3108 Shears                          | 104        | 42B              | Allway Scraper Blade 65mm                                | 98         |
| 320           | Blue Safety Cutter   | 49         | 430-1            | Sterling Yellowtail Safety knife                         | 43         |
| 325           | Green Safety Slitter                                       | 50         | 430B-4           | Replacement Blades for Yellowtail Knife (x10)            | 215        |
| 326-2         | Klever type Safe Edge Cutter Bulk                          | 49         | 440-1            | TUSK Safety Knife  | 48         |
| 330-1         | Yellow Deluxe Autolock Cutter                              | 33         | 441-1            | TUSK II Safety Knife                                     | 48         |
| 33710         | Small Round Router Blade (x2)                              | 206        | 442-1            | Tough Tusk Metal Carton Opener                           | 48         |
| 33720         | Medium Carving V Router Blade (x2)                         | 206        | 445-1            | ResQ Emergency Safety Hammer and Cutter                  | 51         |
| 33730         | Large Round Router Blade (x2)                              | 206        | 446-2            | Super Safe Top Cutter Carton Opener                      | 51         |
| 33740         | Flat Rectangular Router Blade (x2)                         | 206        | 448-2            | Glass Edge Safety Trimmer                                | 56         |
| 340-1         | 9mm Metal Autolock Cutter                                  | 35         | 451-040          | Mica Straight Cornered Blade (x10)                       | 214        |
| 350           | White Safety Cutter  | 49         | 451-040R         | Mica Round Cornered Blade (x10)                          | 214        |
| 35005         | Single Edge Razor Blade (x5)                               | 194        | 4521             | 450mm/18in Stainless Steel Ruler - Metric/Imperial       | 137        |
| 36-150        | Straight Levelling Trowel                                  | 77         | 470-1            | Superslit II Safety Slitter                              | 50         |
| 360-1         | 9mm Stainless Steel Cutter                                 | 37         | 471-040R         | Round Cornered Carton Cutter Blade (x10) for 100B Cutter | 214        |
| 380-1         | 9mm Metal Screwlock Cutter                                 | 35         |                  |  |            |
| 385I          | 3m/10ft Tape Measure - TapeTech                            | 145        | <b>50-085-4</b>  | <b>6in Scraper Blade (x10)</b>                           | <b>197</b> |
| 389           | 3m Tape Measure - TapeTech                                 | 145        | 50-089-4         | 5in Scraper Blades (x10)                                 | 197        |
|               |  |            | 50-151-4         | 4in Scraper Blades (x10)                                 | 196        |
| <b>40-010</b> | <b>Technical 3 Hole Blade Round (x10)</b>                  | <b>211</b> | 50-153-2         | 4in Scraper Blades (x100)                                | 196        |
| 40-030        | Technical 3 Hole Blade 0.3mm (x10)                         | 211        | 50-660           | 6in Hardpoint Drywall Saw                                | 61         |
| 40-101-2      | Round Cornered Slotted Blade (x100)                        | 212        | 50-770           | T-Rex 22in 550mm Hardpoint Handsaw                       | 62         |
| 40-101-4      | Round Slotted Blade (x10)                                  | 212        | 500-1            | Screwlock 18mm Snap Cutter                               | 27         |
| 40-101C       | Round Corner Slotted Blade Cryo                            | 212        | 500-B            | Screwlock 18mm Cutter with Non-Seg. Blade                | 27         |
| 40-101DUR     | Round Cornered Blade Dura Coated                           | 212        | 50001            | Light Duty Precision Art Knife                           | 125        |
| 40-101TCN     | Slotted Blade - Round Cornered TiCN Coated                 | 212        | 50002            | Medium Duty Precision Art Knife                          | 126        |
| 40-101TIC     | Slotted Blades Round Cornered Carbide Coated               | 212        | 50003            | Light Duty Pen Knife                                     | 126        |
| 40-101TNC     | Slotted Blade - Round Cornered TiN Coated                  | 212        | 50004            | Swivel Art Knife   | 126        |
| 40-150-2      | Square Slotted Blade (x100)                                | 212        | 50005            | Knife #5 Red   | 126        |
| 40-150-2C     | Sqaure Slotted Blades (x100) - Cryo                        | 212        | 550-1            | STERLING 18mm Yellow Screw-Lock Cutter                   | 27         |
| 40-150-4TNC   | Slotted Blade - Square Corner TiN Coated (x10)             | 212        | 570-1            | Yellow 18mm Screwlock Cutter                             | 27         |
| 40-150BD      | Slotted Blade - Square Corner Black Diamond Coated         | 212        | 580-1            | Zebra Screwlock Cutter                                   | 25         |
| 40-150DUR     | Square Corner Slotted Blade Dura Coated                    | 212        | 58-120           | Yellow Throwaway Knife                                   | 56         |
| 40-150TCN     | Slotted Blade - Square Corner TiCN Coated                  | 212        | 58-120R          | Orange Throwaway Knife - Safety Point                    | 56         |
| 40-150TNC     | Slotted Blade - Square Corner TiN Coated                   | 212        | 58-151P          | Roe Knife with Stainless Steel                           | 54         |
| 40-201-4      | STERLING 8in Scraper Blade (x10)                           | 197        | 58-546           | Lunar Knife - Stainless Steel Blade                      | 54         |
| 40-500-4      | Crain Type Strip Cutter Blades (x10)                       | 214        | 589              | 5m Measuring Tape - TapeTech                             | 145        |
| 401-1         | Straight Edge Keyhole Blade (x3)                           | 204        | 589I             | 5M/16ft Measuring Tape - TapeTech                        | 145        |
| 401-2         | Straight Edge Keyhole Blade (x100)                         | 204        | 590-1            | Silver Metal Screwlock                                   | 26         |
| 401TNC        | Straight Edge Keyhole Blade                                | 204        |                  |  |            |
| 404-1         | Convex Keyhole Blade (x3)                                  | 204        | <b>60-20G</b>    | <b>Technical 3 Hole Blade Square Cornered</b>            | <b>213</b> |
| 404-2         | Convex Keyhole Blade (x50)                                 | 204        | 6021             | 600mm/24in Stainless Steel Ruler - Metric/Imperial       | 137        |
| 404TNC        | Convex Keyhole Blade                                       | 204        | 6021-A           | 600mm Aluminum Ruler                                     | 138        |
| 405-1         | Keyhole Blade Short Angle (x3) Carded                      | 204        | 6021-AR          | 600mm Aluminium Ruler with Rubber Back                   | 138        |
| 405-2         | Short Angle Keyhole Blade (x100)                           | 204        | 6021-M           | 600mm Stainless Steel Ruler - Metric Only                | 137        |
| 405TNC        | Short Angle Keyhole Blade                                  | 204        | 61-109           | ULTRAKEEN Single Edge Razor Blades (x100)                | 193        |
| 406-1         | Keyhole Blade Long Angle (x3) carded                       | 204        | 6110-M           | Cable Tacker Staples 10mm (x1000)                        | 169        |
| 406-2         | Long Angle Keyhole Blade (x50)                             | 205        | 6212-M           | Cable Tacker Staples 12mm (x1000)                        | 169        |
| 406TNC        | Long Angle Keyhole Blade                                   | 205        | 6234             | 4in Scraper Blade (x10)                                  | 196        |
| 407-3         | Laila Craft Blade  | 205        | 625-1            | Snaploader Autoloading Cutter                            | 29         |
| 411-1         | Easy-Cut Self Retracting Cutter System with Holster Carded | 41         | 626              | Tortise Shell Scissors                                   | 123        |
| 411-2         | Easy-Cut Self Retracting Cutter System with Holster        | 41         | 655-1            | Yellow Heavy Duty Autolock Cutter                        | 30         |
| 411B-1        | Easy-Cut Replacement Blades Card (x10)                     | 41         | 670-1            | Yellow Autolock cutter                                   | 29         |
| 411B-2        | Dispenser (x80) Replacement Blades for Easy-Cut            | 41         | 68               | Yellow Plastic Cutter with Metal Insert                  | 31         |
| 412-1         | Sideslide Safety Knife                                     | 43         | 680-1            | Zebra Autolock Cutter                                    | 29         |
| 412-L         | Side-Slide Left Handed Self Retracting Knife               | 44         | 690-1            | Silver Metal Autolock Cutter                             | 28         |
| 412B          | Slidlock Knife Blades (x10)                                | 179        |                  |  |            |
| 413-1         | Safety Autoretracting Pocket Cutter                        | 41         | <b>70-1102-2</b> | <b>Injector Blades - Stainless Steel (x1000)</b>         | <b>215</b> |
| 414-1         | Side Lever Safety Knife                                    | 42         | 70-1102-3        | Injector Blades - Stainless Steel (x20)                  | 215        |
| 415           | Sideslide Junior Safety Knife                              | 45         | 70-1102BD        | Injector Blade Black Diamond                             | 215        |
| 416-1         | Longreach Safety Self-Retracting Knife                     | 42         | 70-1102TCN       | Injector Blade - Stainless Steel TiCN Coated             | 215        |

| Stock Code | Description  | Page No. |
|------------|--|----------|
| 70-1102TIC | Injector Blades Carbide Coated                         | 215      |
| 70-1102TNC | Injector Blade - Stainless Steel TIN Coated            | 215      |
| 70-201-2   | STERLING Fibreglass Chopper Blade - 1.00in (x100)      | 215      |
| 70-225-2   | Fibreglass Chopper Blade - 0.8in (x100)                | 215      |
| 700-1      | STERLING 25mm Yellow Extra Heavy Duty Cutter           | 23       |
| 701-1      | STERLING 25mm Red Extra Heavy Duty Cutter              | 22       |
| 7163-C2    | 2in/50mm Carbon Steel Scraper Plastic Handle           | 93       |
| 7163-S1    | 1in/25mm Stainless Steel Scraper Plastic Handle        | 93       |
| 7163-S1.5  | 1-1/2in/38mm Stainless Steel Scraper Plastic Handle    | 93       |
| 7163-S2    | 2in/50mm Stainless Steel Scraper Plastic Handle        | 93       |
| 7163-S3    | 3in/75mm Stainless Steel Scraper Plastic Handle        | 93       |
| 7163-S4    | 4in/100mm Stainless Steel Scraper Plastic Handle       | 93       |
| 7363-S1    | 1in/25mm Stainless Steel Scaper with Rhinogrip Handle  | 92       |
| 7363-S2    | 2in/50mm Stainless Steel Scaper with Rhinogrip Handle  | 92       |
| 7363-S3    | 3in/75mm Stainless Steel Scaper with Rhinogrip Handle  | 92       |
| 7363-S4    | 4in/100mm Stainless Steel Scaper with Rhinogrip Handle | 92       |
| 760-1      | Commander Extra Large Cutter                           | 23       |
| 78-407     | Red Handle 8in Forged Smooth Blade Scissors            | 116      |
| 78-408     | 8in. Tailoring Shears - Serrated                       | 116      |
| 78-408L    | 8in Lefthanded Shears                                  | 116      |
| 78-410     | 10in. Forged Tailoring Shears                          | 116      |
| 78-410L    | 10in. Left Handed Tailoring Shears                     | 116      |
| 78-412     | 12in. Forged Tailoring Shears                          | 116      |
| 78-415     | 10in Forged Serrated Edge Tailoring Shears             | 117      |
| 78-416     | 12in Forged Serrated Edge Tailoring Shears             | 117      |

**80 Yellow Plastic Cutter 31**

|           |   |     |
|-----------|---|-----|
| 80-010TNC | Technical 3 Hole Blade Square Cornered TNC Coated | 211 |
| 80-015TNC | 3 Hole Technical Blade Tin Coated                 | 211 |
| 80-020    | Technical 3 Hole Blade Square Cornered (x10)      | 211 |
| 80-040    | Technical 3 Hole Blade Square Cornered (x10)      | 211 |
| 80-200    | Metal Heavy Duty Scraper with Brass Button        | 87  |
| 80-202    | Metal Heavy Duty Scraper                          | 88  |
| 80-202B   | Metal Scraper                                     | 88  |
| 80-214    | Mini Scraper with 1 Blade                         | 89  |
| 802       | Boot Knife with Wooden Handle                     | 55  |
| 803       | Boot Knife with Wooden Handle                     | 55  |
| 804       | Boot Knife with Plastic Handle                    | 55  |
| 804H      | Boot Knife with Plastic Handle and Holster        | 55  |
| 805-1     | Hacking Knife                                     | 57  |
| 806       | 215mm Tortoise Shell Office Scissors              | 123 |
| 811004    | 4in Scraper Blade Single Sided (x10)              | 196 |
| 82        | Black/Yellow Safety Carton Opener                 | 49  |
| 820402    | 40mm Snappy Type Scraper Blade Double Side (x10)  | 198 |
| 820802    | 80mm Scraper Blade Double Side (x10)              | 198 |
| 820943    | 94mm Scraper Blade Double Sided (x10)             | 198 |
| 821002    | 100mm Scraper Blade Double Side (x10)             | 199 |
| 821252    | 5in Scraper Blade Double Sided (x10)              | 199 |
| 821502    | 6in Scraper Blade Double Side (X10)               | 199 |
| 8237      | Perforator Blade                                  | 213 |
| 8340      | Arrow Head Blade (x10)                            | 213 |
| 846       | 8m Rubber Case Measuring Tape - TapeTech          | 144 |
| 846l      | 8M/27ft Rubber Case Tape Measure - TapeTech       | 144 |
| 852-020   | 80mm Scraper Blade Double Side (x25)              | 198 |
| 854-020   | 6in Scraper Blade Double Sided (x25)              | 199 |
| 854-020B  | 6in Scraper Blade                                 | 199 |
| 889       | 8M Tape Measure - TapeTech                        | 145 |
| 889l      | 8M/26ft Tape Measure - TapeTech                   | 145 |
| 894-030   | 94mm Scraper Blade Double Sided (x25)             | 198 |

**902-1 Yellow Auto-Lock Cutter with Metal Insert 30**

|        |  |     |
|--------|--|-----|
| 905-1  | Yellow Plastic Auto-Lock Cutter        | 36  |
| 911-1  | Standard Duty Blade Card (x5)          | 178 |
| 911-2  | Standard Duty Blade Box (x100)         | 178 |
| 911-2D | Standard Duty Blade Dispenser (x100)   | 178 |
| 911-3  | Standard Duty Blade (x5)               | 178 |
| 911-4D | Standard Duty Blade Dispenser (x10)    | 178 |
| 915-3  | 2 Hole Trimmer Blade (x5)              | 178 |
| 915-4D | 2 Hole Trimmer Blade (x10)             | 178 |
| 921-1  | Heavy Duty Blade Card (x5)             | 175 |
| 921-2  | Heavy Duty Blades Box (x100)           | 175 |
| 921-2D | Heavy Duty Blade Dispenser (x100)      | 175 |
| 921-3  | Heavy Duty Blades (x5)                 | 175 |
| 921-4D | Heavy Duty Blade Dispenser (x10)       | 175 |
| 921-TD | Heavy Duty Blade Tungsten Disp. (x100) | 175 |
| 9210-3 | Heavy Duty Blade with 3 Notches (x5)   | 177 |
| 922-3  | Heavy Duty Blade with Centre Hole (x5) | 177 |

| Stock Code | Description   | Page No. |
|------------|---|----------|
| 924-3      | Heavy Duty Blade with 4 Holes (x5)                  | 177      |
| 924-3SS    | Heavy Duty Blade with 4 Holes Stainless Steel (x5)  | 177      |
| 924-4D     | Heavy Duty Blade with 4 Holes Disp.10               | 177      |
| 926-3      | Heavy Duty Blade 5 Hole 3 Notch (x5)                | 177      |
| 928-2      | Heavy Duty Bull Nose Blade (x100)                   | 176      |
| 928-2D     | Heavy Duty Bull Nose Blade in Dispenser Pack (x100) | 176      |
| 928-3      | Heavy Duty Bull Nose Blade (x5)                     | 176      |
| 928-4D     | Heavy Duty Bull Nose Blade in Dispenser (x10)       | 176      |
| 941-2      | Trimmer Blade Box (x100)                            | 178      |
| 941-2D     | Trimmer Blade Dispenser (x100)                      | 178      |
| 941-3      | Trimmer Blade (x5)                                  | 178      |
| 941-4D     | Trimmer Blade Dispenser (x10)                       | 178      |
| 9600-3     | Special Hook Blade (x5)                             | 180      |
| 961-1      | Hooked Blade Card (x5)                              | 180      |
| 961-2      | Hooked Blade Box (x100)                             | 180      |
| 961-2D     | Hooked Blade Dispenser (x100)                       | 180      |
| 961-3      | Hooked Blade (x5)                                   | 180      |
| 961-4D     | Hooked Blade Dispenser (x10)                        | 180      |
| 962-3      | Deep Hook Blade (x5)                                | 181      |
| 962-4D     | Deep Hook Blade Dispenser 10                        | 181      |
| 963-3      | Hooked Blade with Centre Hole (x5)                  | 180      |
| 963-4D     | Hooked Blade with Centre Hole (x10)                 | 180      |
| 964-3      | Medium Hook Blade (x5)                              | 181      |
| 964-4D     | Medium Hooked Blade Disp.10                         | 181      |
| 968-3      | Hooked Blade with Blunt Points (x5)                 | 181      |
| 968-4D     | Hook Blades with Blunt Points (x10)                 | 181      |
| 98         | Letter Opener                                       | 50       |
| 981-3      | Convex Blade (x5)                                   | 183      |
| 9900       | 230mm Pinking Scissors                              | 120      |
| 991-1      | Concave Blade Card (x5)                             | 182      |
| 991-2      | Concave Blade Box (x100)                            | 182      |
| 991-2D     | Concave Blade Dispenser (x100)                      | 182      |
| 991-3      | Concave Blade (x5)                                  | 182      |
| 991-4D     | Concave Blade Dispenser (x10)                       | 182      |
| 991-TD     | Concave Blade Tungsten Dispenser (x100)             | 182      |
| 992-3      | Concave Blade with 3 Holes (x5)                     | 182      |
| 992-4D     | Concave Blade with 3 Holes Disp.10                  | 182      |

**A-300 Cream Autolock Cutter with Stainless Sleeve 34**

|            |  |     |
|------------|--|-----|
| A0G3       | Green Cutting Mat A0 1200x900mm                | 132 |
| A0G3D      | Dual Measurement Cutting Mat 1200x900mm        | 132 |
| A1106-2M   | 6mm A11 Style Staples - box 2000               | 164 |
| A1106-5M   | 6mm A11 Style Staples - box 5000               | 164 |
| A1108-2M   | 8mm A11 Style Staples - box 2000               | 164 |
| A1108-2MSP | 8mm A11 Style Sharp Point Staples (x2000)      | 164 |
| A1108-2MSS | 8mm A11 Style Stainless Steel Staples (x2000)  | 165 |
| A1108-5M   | 8mm A11 Style Staples - box 5000               | 164 |
| A1108-5MSP | 8mm A11 Style Sharp Point Staples (x5000)      | 164 |
| A1108-5MSS | 8mm A11 Style Stainless Steel Staples (x5000)  | 165 |
| A1110-2M   | 10mm A11 Style Staples - box 2000              | 164 |
| A1110-2MSP | 10mm A11 Style Sharp Point Staples (x2000)     | 164 |
| A1110-2MSS | 10mm A11 Style Stainless Steel Staples (x2000) | 165 |
| A1110-5M   | 10mm A11 Style Staples - box 5000              | 164 |
| A1110-5MSP | 10mm A11 Style Sharp Point Staples (x5000)     | 164 |
| A1110-5MSS | 10mm A11 Style Stainless Steel Staples (x5000) | 165 |
| A1112-2M   | 12mm A11 Style Staples - box 2000              | 164 |
| A1112-5M   | 12mm A11 Style Staples - box 5000              | 164 |
| A1112-2MSS | 12mm A11 Style Stainless Steel Staples (x2000) | 165 |
| A1112-5MSS | 12mm A11 Style Stainless Steel Staples (x5000) | 165 |
| A1306-5M   | Series 13 Staples 6mm (x5000)                  | 167 |
| A1308-5M   | 8mm 13 Series Staples (x5000)                  | 167 |
| A1310-5M   | Series 13 Staples 10mm (x5000)                 | 167 |
| A1G3       | Green Cutting Mat A1 900x600mm                 | 132 |
| A1G3D      | Dual Green Cutting Mat A1 900x600mm            | 132 |
| A1T3       | Translucent Cutting Mat A1 900x600mm           | 133 |
| A2606-5M   | 6mm 26 Series Staples (x5000)                  | 167 |
| A2608-5M   | 8mm 26 Series Staples (x5000)                  | 167 |
| A4012-5M   | 12mm 4000 Series Staples - box 5000            | 166 |
| A4014-5M   | 14mm 4000 Series Staples - box 5000            | 166 |
| A4016-5M   | 16mm 4000 Series Staples - bulk 5000           | 166 |
| A4018-5M   | 18mm 4000 Series Staples - bulk 5000           | 166 |
| A4020-5M   | 20mm 4000 Series Staples - bulk 5000           | 166 |
| A4022-5M   | 22mm 4000 Series Staples - bulk 5000           | 166 |
| A6016-5M   | 16mm 6000 Series Staples - Box 5000            | 166 |
| A6018-5M   | 18mm 6000 Series Staples - bulk 5000           | 166 |
| A6020-5M   | 20mm 6000 Series Staples - bulk 5000           | 166 |
| A6022-5M   | 22mm 6000 Series Staples - bulk 5000           | 166 |



| Stock Code  | Description   | Page No.   |
|-------------|---|------------|
| A6025-5M    | 25mm 6000 Series Staples - bulk 5000                            | 166        |
| A6032-5M    | 32mm 6000 Series Staples - bulk 5000                            | 166        |
| A6038-5M    | 38mm 6000 Series Staples - bulk 5000                            | 166        |
| A7310-5M    | 10mm 73 Series Staples (x5000)                                  | 168        |
| A7312-5M    | 12mm 73 Series Staples (x5000)                                  | 168        |
| A8010-10M   | 10mm 80 Series Staples - bulk 10,000 (similar to 86/800 series) | 169        |
| A8010-10MPB | 80 Series Staples - bulk 10,000 Plastic Box                     | 169        |
| A8010-5MPB  | 80 Series Staples - bulk 5,000 Plastic Box                      | 169        |
| A8012-5MPB  | 80 Series Staples - bulk 5,000 Plastic Box                      | 169        |
| A8012-10M   | 12mm 80 Series Staples - bulk 10,000 (similar to 86/800 series) | 169        |
| A8014-5MPB  | 80 Series Staples - bulk 5,000 Plastic Box                      | 169        |
| A8060-10M   | 80 Series Staples - bulk 10,000                                 | 169        |
| A8060-10MPB | 80 Series Staples - bulk 10,000 Plastic Box                     | 169        |
| A8080-10M   | 80 Series Staples - bulk 10,000                                 | 169        |
| A8080-10MPB | 80 Series Staples - bulk 10,000 Plastic Box                     | 169        |
| A9714-5M    | 97 Series Staples 14mm Long - Box 5000                          | 168        |
| A9716-5M    | 97 Series Staples 16mm Long - Box 5000                          | 168        |
| A9718-5M    | 97 Series Staples 18mm Long - Box 5000                          | 168        |
| A9722-5M    | 97 Series Staples 22mm Long - Box 5000                          | 168        |
| A2G3        | Green Cutting Mat A2 600x450mm                                  | 132        |
| A2G3D       | Dual Green Cutting Mat A2 600x450mm                             | 132        |
| A2T3        | Translucent Cutting Mat A2 600x450mm                            | 133        |
| A300GRP     | NT Metal AutoLock Cutter 9mm                                    | 34         |
| A300RP      | NT Autolock Cream Cutter 9mm                                    | 34         |
| A3G3        | Green Cutting Mat A3 450x300mm                                  | 132        |
| A3G3D       | Dual Green Cutting Mat A3 450x300mm                             | 132        |
| A3T3        | Translucent Cutting Mat A3 450x300mm                            | 133        |
| A4G3        | Green Cutting Mat A4 300x220mm                                  | 132        |
| A4G3D       | Dual Green Cutting Mat A4 300x220mm                             | 132        |
| A4T3        | Translucent Cutting Mat A4 300x220mm                            | 133        |
| A5G3        | Green Cutting Mat A5  | 132        |
| AG5519-10M  | 19mm (3/4in) Staples - bulk 10,000 (G5562-19)                   | 165        |
| AG5525-10M  | 25mm (1in) Staples - bulk 10,000 (G5562-25)                     | 165        |
| AG5535-10M  | 35mm (1-5/8in) Staples - bulk 10,000 (G5562-35)                 | 165        |
| AG5538-10M  | 38mm (1-1/2in) Staples - bulk 10,000 (G5562-38)                 | 165        |
| AH-915      | Sterling Heavy Duty Hammer Tacker                               | 158        |
| ALC3013     | 30M Y-Liner Open Reel Measuring Tape                            | 148        |
| ALC5013     | 50M Y-Liner Open Reel Measuring Tape                            | 148        |
| AP-250      | Plier Type Stapler  | 162        |
| AP-270      | Multi-Functional Plier Tape Stapler                             | 163        |
| AR-425      | Stapler Remover   | 163        |
| AT-301      | Handy Tacker  | 162        |
| AT-516      | Apexon F13 Multi-functional 3 Way Staple Gun (R-83)             | 159        |
| AT-765B     | Apexon Heavy Duty Staple Gun                                    | 159        |
| AT-901      | Apexon A11 Target One Heavy Duty Staple Gun                     | 157        |
| AT-911      | Multi-Functional 3 Way Staple Gun (R-23)                        | 160        |
| AT-916      | Multi-Functional 3 Way Staple Gun (R-33)                        | 160        |
| AT-961      | Cable Tacker - Die Cast - 9-11mm                                | 161        |
| AT-962      | Cable Tacker - Die Cast - 10-14mm (R-36)                        | 161        |
| <b>B-39</b> | <b>Arrow Head Replacement Blades (x10)</b>                      | <b>213</b> |
| B3013       | 30M Closed Case Fibreglass Tape Measure                         | 146        |
| BA-100      | Small Snap Blades 9mm (x5 blades)                               | 190        |
| BD-100      | Blades 9mm 5pk  | 190        |
| BDA-200P    | NT Standard Angle Replacement Blades (x40)                      | 189        |
| BDC-200P    | NT Sharp Angle Replacement Blades (x40)                         | 189        |
| BF1         | Allway Blade File   | 99         |
| BF2         | Mini Blade File   | 99         |
| BHL         | Blade Holder for HDSCR scraper                                  | 91         |
| BL-150P     | NT 18mm Large Snap Blades (x6)                                  | 187        |
| BL-51P      | NT Large Snap Blades 50pk                                       | 187        |
| BLC         | Red Blade Cover   | 91         |
| BLR-1       | 0.5 litre 1Kg Sharps Disposal Container                         | 59         |
| BLR-2       | 2 Litre 2Kg Sharps Disposal Container                           | 59         |
| BLR-5       | 5 Litre 5Kg Sharps Disposal Container                           | 59         |
| BLR-B       | Blademate Sharps Container                                      | 59         |

| Stock Code    | Description                                     | Page No.   |
|---------------|---|------------|
| BSL-11P       | NT 18mm Snap Blades for SL-1P (x10)             | 189        |
| BTC35         | Leather Holster for Boot Knife                  | 155        |
| <b>C-10</b>   | <b>Universal Deburring Blades</b>               | <b>225</b> |
| C-101         | Small Hole Deburring Blades                     | 225        |
| C-15          | Deburring Blades for Stainless                  | 225        |
| C-1500P       | Circle Cutter                                   | 128        |
| C-20          | Deburring Blades for Brittle Material           | 225        |
| C-30          | Edge Deburring Blades                           | 225        |
| C-3000GP      | H/D Circle Cutter                               | 128        |
| C-60          | Backside Deburring Blades                       | 225        |
| CB10          | 1in Carbide Blade                               | 100        |
| CB20          | 2in Carbide Blade                               | 101        |
| CB25          | 2 1/2in Carbide Blade                           | 101        |
| CBB-14A       | 14tpi Air Hacksaw Blades - ALPHA (x10)          | 173        |
| CBB-18A       | 18tpi Air Hacksaw Blades - ALPHA (x10)          | 173        |
| CBB-18MPS     | 18tpi Air Hacksaw Blades - MPS (x5)             | 173        |
| CBB-24A       | 24tpi Air Hacksaw Blades - ALPHA (x10)          | 173        |
| CBB-24MPS     | 24tpi Air Hacksaw Blades - MPS (x5)             | 173        |
| CBB-32A       | 32tpi Air Hacksaw Blades - ALPHA (x10)          | 173        |
| CBB-32MPS     | 32tpi Air Hacksaw Blades - MPS (x5)             | 173        |
| CBS10         | 1in Carbide Scraper                             | 100        |
| CBS20         | 2in Carbide Scraper                             | 100        |
| CBS25         | 2 1/2in Carbide Scraper                         | 100        |
| CBSM6         | Carbide Scraper Merchandiser                    | 101        |
| CE-700P       | NT Circle Cutter Extension Bar                  | 128        |
| COMBS52       | Combination Square No.52 Metric Only            | 139        |
| COMBS52ME     | Combination Square No.52 Metric / English       | 139        |
| COMBS53       | Combination Square Heavy Duty No.53 Metric Only | 139        |
| COMBS53ME     | Combination Square No.53 Metric / English       | 139        |
| C-1           | Ceramic Blade                                   | 226        |
| CS-12         | 12mm Hand Countersink                           | 224        |
| CS-20         | 20mm Hand Countersink                           | 224        |
| CS-30         | 30mm Hand Countersink                           | 224        |
| CS6           | Softgrip Contour Scraper Compl                  | 96         |
| CS-B1         | Blade   | 96         |
| CS-B2         | Blade   | 96         |
| CS-B3         | Blade   | 96         |
| CS-B4         | Blade   | 96         |
| CS-B5         | Blade   | 96         |
| CS-B6         | Blade   | 96         |
| CSH           | Long Countersink Tool Handle                    | 224        |
| CS-LONG       | Long Holder for Countersinks                    | 224        |
| CT-MK         | Ceramic Deburring Tool                          | 223        |
| CVT-6         | Lino Carving Tool                               | 129        |
| CVT-P         | Pin Lino Tool                                   | 129        |
| CVT-U1        | Lino Carving Tool - U1                          | 129        |
| CVT-U2        | Lino Carving Tool - U2                          | 129        |
| CVT-U3        | Lino Carving Tool - U3                          | 129        |
| CVT-U4        | Lino Carving Tool - U4                          | 129        |
| CVT-V1        | Lino Carving Tool - V1                          | 129        |
| CVT-V2        | Lino Carving Tool - V2                          | 129        |
| <b>D-1000</b> | <b>NT Art Knife</b>                             | <b>128</b> |
| D-12GR        | Design Knife                                    | 128        |
| D-803         | Orange 18mm Plastic Cutter                      | 31         |
| D-803A        | Orange Plastic Cutter Carded                    | 31         |
| D-804         | Orange 9mm Plastic Cutter                       | 36         |
| D-804A        | 9mm Orange Plastic Cutter - carded              | 36         |
| DB-48         | Precision Art Blade (x48)                       | 128        |
| DT-1-10       | Economy Deburring Tool in Bucket                | 223        |
| DT-1-2        | Economy Deburring Tool                          | 223        |
| DT-5C-MK      | Comfort Grip Deburring Tool + 5 Blades          | 222        |
| DT-C          | C Deburring Blade Holder                        | 224        |
| DT-P          | P Deburring Blade Holder                        | 224        |
| DT-MK         | Comfort Grip Deburrer                           | 221        |

| Stock Code       | Description  | Page No.   |
|------------------|--|------------|
| DTK-14           | Deburring Tool Kit 14 Pce                            | 227        |
| DTK-24           | Deburring Tool Kit 24 Pce                            | 227        |
| DVZ1935          | 3.5m x 19mm KDS Measuring Tape                       | 150        |
| DVZ1950          | 5m x 19mm KDS Tape Measure                           | 150        |
| DVZ2575          | 7.5m x 25mm KDS Tape Measure                         | 150        |
| <b>EG3013</b>    | <b>30m Closed Case Fibreglass Tape Measure</b>       | <b>145</b> |
| END8025          | 8m x 25mm ENDURO Stainless Steel Tape Measure        | 141        |
| END8025I         | 8m/27ft x 25mm ENDURO Stainless Steel Measuring Tape | 141        |
| ES4405           | Black Embroidery Scissors                            | 119        |
| ET-1             | Comfort Grip P Holder                                | 223        |
| ET-2             | Comfort Grip C Holder                                | 223        |
| <b>F1</b>        | <b>Handy Scraper</b>                                 | <b>95</b>  |
| F10-02DM         | 2m Steel Diameter Tape Measure                       | 149        |
| F200             | Fish Safety Knife                                    | 51         |
| F4               | Super Scraper  | 95         |
| FE1              | Softgrip Handy Scraper 2 Edge                        | 96         |
| FE2              | Allway Scraper                                       | 96         |
| FE4              | Softgrip Handy Scraper 4 Edge                        | 97         |
| FEB7             | Allway Merchandiser                                  | 97         |
| FHT910           | Maxifast A11 Hammer Tacker (R-11)                    | 158        |
| FR8033           | FatRhino 8m x 33mm Measuring Tape                    | 143        |
| FR8033I          | FatRhino 8m/27ft x 33mm Measuring Tape               | 143        |
| FS-8             | 8in Floor Scraper                                    | 94         |
| FS-8BL           | Replacement Blade for FS-8                           | 94         |
| <b>GB-10H</b>    | <b>KDS Large Snap Blade x Tube 10</b>                | <b>186</b> |
| GB-50H           | KDS Large Snap Blade                                 | 186        |
| GES25-80ME       | 8m/26ft x 25mm KDS G-Edition Tape Measure            | 150        |
| GES25-80MM       | 8m x 25mm KDS G-Edition Tape Measure                 | 150        |
| GS-1             | Brass Button Scraper + 5 Blades                      | 87         |
| <b>H-12YE-3B</b> | <b>25mm KDS Job Boss Pro Cutter + 3 Blades</b>       | <b>22</b>  |
| H-13             | KDS Job-Boss Soft Grip Large Cutter                  | 22         |
| HB-10BH          | KDS Extra Large Power Black Snap Blade (x10)         | 188        |
| HC-020           | 20oz Claw Hammer                                     | 65         |
| HC-024           | 24oz Claw Hammer                                     | 65         |
| HDSCR            | 94mm Black Plastic Scraper                           | 91         |
| HF-40T           | Sterling Industrial Hacksaw Frame                    | 63         |
| HF-506           | Aluminium Hacksaw Frame                              | 63         |
| HOLST-B          | Black Plastic Holster                                | 154        |
| HOLST-C          | Canvas Knife Holster                                 | 154        |
| HOLST-ST         | Sterling Canvas Holster with Cap                     | 154        |
| HOLST-Y          | Yellow Plastic Holster                               | 154        |
| HX-520           | 20oz Striker Sterling Hammer                         | 65         |
| <b>JH-010</b>    | <b>Multi Sharpener</b>                               | <b>57</b>  |
| <b>KBS5</b>      | <b>Allway Heavy Duty Blades 3 Notch Round Point</b>  | <b>177</b> |
| KDLB-10BH        | KDS 18mm Large Power Black Snap Blade (x10)          | 187        |
| KDLB-50BH        | KDS 18mm Large Power Black Snap Blade (x50)          | 187        |
| KGM8027          | 8m x 27mm KINGGRIP Magnetic Hook Measuring Tape      | 142        |
| KGM8027I         | 8m/27ft x 27mm KINGGRIP Magnetic Hook Measuring Tape | 142        |
| KL1020ME         | 20m x 10mm KDS Long Steel Tape                       | 150        |
| KW               | Keyway Deburring Blade Holder                        | 224        |
| KW-16            | 16mm Keyway Deburring Blade                          | 226        |
| KW-9             | 9mm Keyway Deburring Blade                           | 226        |
| <b>L-25</b>      | <b>KDS Multi Pro Screw-Lock 18mm Snap Cutter</b>     | <b>26</b>  |
| L-500P           | NT Red 18mm Screwlock Cutter                         | 27         |
| LB-10H           | KDS 18mm Large Snap Blades (x10)                     | 186        |
| LB-50H           | KDS 18mm Large Snap Blades (x50)                     | 186        |
| LFP3013I         | 30M/100ft Pistol Steel Open Reel Tape Measure        | 149        |
| LFP5013I         | 50M/165ft Pistol Steel Open Reel Tape Measure        | 149        |
| LJ10660          | Smart Edge Scissor - 160mm                           | 120        |
| LJ10685          | Smart Edge Scissor - 225mm                           | 120        |
| LJ10695          | Smart Edge Scissor - 240mm                           | 120        |
| <b>MF102-P1</b>  | <b>Large Universal Shear with Single Tube Anvil</b>  | <b>104</b> |
| MF102-P2         | Large Universal Shear with Double Tube Anvil         | 104        |
| MN25-02          | MINI ROD 25mm wide with 2m + ROD markings            | 150        |
| MP-342           | 7in Duckbilled Napping Shears                        | 105        |
| MP-400           | 8in Offset Napping Shears                            | 105        |
| MW06             | Sterling Mini Wheelwalker Measuring Wheel            | 149        |
| MW12             | Sterling Wheelwalker Measuring Wheel                 | 148        |

| Stock Code     | Description   | Page No.   |
|----------------|---|------------|
| <b>NK10010</b> | <b>100m Open Reel 3x Speed Winder Sterling Steel Tape Measure</b> | <b>146</b> |
| NK3010         | 30m Open Case 3x Speed Winder Sterling Steel Tape Measure         | 146        |
| NK5010         | 50m Open Reel 3x Speed Winder Sterling Steel Tape Measure         | 146        |
| NKS-9          | 1/4 Moon Knife - Made in Sheffield England                        | 68         |
| No.10          | Scalpel Blades - No.10  | 217        |
| No.10A         | Scalpel Blades - No.10A   | 217        |
| No.10AD        | Disposable Scapel Blades No.10A - box 10                          | 219        |
| No.10ASM       | Scalpel Blades No.10A - Swann Morton                              | 217        |
| No.10D         | Disposable Scalpel Blade + Handle No.10 - box 10                  | 219        |
| No.10SM        | Scalpel Blades No.10 - Swann Morton                               | 217        |
| No.11          | Scalpel Blades - No.11  | 217        |
| No.11D         | Disposable Scalpel Blade + Handle No.11 - box 10                  | 219        |
| No.11DSM       | Disposable Scalpel Blade + Handle No.11 - box 10                  | 219        |
| No.11SM        | Scalpel Blades No.11 - Swann Morton                               | 217        |
| No.12          | Scalpel Blades - No.12  | 217        |
| No.12D         | Disposable Scapel Blade + Handle No.12 - box 10                   | 219        |
| No.12SM        | Scalpel Blades No.12 - Swann Morton                               | 217        |
| No.14          | Scalpel Blades - No.14  | 217        |
| No.14SM        | Scalpel Blades No.14 - Swann Morton                               | 217        |
| No.15          | Scalpel Blades - No.15  | 217        |
| No.15D         | Disposable Scalpel Blade + Handle No.15 - box 10                  | 219        |
| No.15DSM       | Disposable Scalpel Blade + Handle No.15 - box 10                  | 219        |
| No.15SM        | Scalpel Blades No.15 - Swann Morton                               | 217        |
| No.16          | Scalpel Blades - No.16  | 217        |
| No.20          | Scalpel Blades - No.20  | 218        |
| No.20SM        | Scalpel Blades No.20 - Swann Morton                               | 218        |
| No.21          | Scalpel Blades - No.21  | 218        |
| No.21SM        | Scalpel Blades No.21 - Swann Morton                               | 218        |
| No.22          | Scalpel Blades - No.22  | 218        |
| No.22A         | Scalpel Blades - No.22A   | 218        |
| No.22AD        | Disposable Scalpel Blade + Handle No.22A - box 10                 | 219        |
| No.22ASM       | Scalpel Blades No.22A - Swann Morton                              | 218        |
| No.22DSM       | Disposable Scalpel Blade + Handle No.22 - box 10                  | 219        |
| No.22SM        | Scalpel Blades No.22 - Swann Morton                               | 218        |
| No.23          | Scalpel Blades - No.23  | 218        |
| No.23DSM       | Disposable Scalpel Blade + Handle No.23 - box 10                  | 219        |
| No.23SM        | Scalpel Blades No.23 - Swann Morton                               | 218        |
| No.24          | Scalpel Blades - No.24  | 218        |
| No.24DSM       | Disposal scalpel blade & handle                                   | 219        |
| No.24SM        | Scalpel Blades No.24 - Swann Morton                               | 218        |
| No.25          | Scalpel Blades - No.25  | 218        |
| No.25A         | Scalpel Blades - No.25A   | 218        |
| No.25ASM       | Scalpel Blades No.25A - Swann Morton                              | 218        |
| No.25SM        | Scalpel Blades No.25 - Swann Morton                               | 218        |
| No.26          | Scalpel Blades - No.26  | 218        |
| No.26SM        | Scalpel Blades No.26 - Swann Morton                               | 218        |
| No.3SM         | No.3 Scalpel Handle Stainless Steel                               | 127        |
| No.3SS         | No.3 Stainless Steel Scalpel Handle                               | 127        |
| No.4SM         | No.4 Scalpel Handle Nickel Alloy                                  | 127        |
| No.4SS         | No.4 Stainless Steel Scalpel Handle                               | 127        |
| No.6           | Scalpel Blades - No.6   | 217        |
| No.6SM         | Scalpel Blades No.6 - Swann Morton                                | 217        |
| No.9           | Scalpel Blades - No.9   | 217        |
| No.9SM         | No.9 Scalpel Blades   | 217        |
| NP10013        | 100M Open Case Fibreglass Tape Measure                            | 147        |
| NP1513         | 15M Open Case Fibreglass Tape Measure                             | 147        |
| NP3013         | 30M Open Case Fibreglass Tape Measure                             | 147        |
| NP5013         | 50M Open Case Fibreglass Tape Measure                             | 147        |
| NR10010        | 100m Open Reel Nylon Coated Steel Sterling Measuring Tape         | 146        |
| NR3010         | 30m Open Reel Nylon Coated Steel Sterling Tape Measure            | 146        |
| NR5010         | 50m Open Reel Nylon Coated Steel Sterling Tape Measure            | 146        |
| <b>OF10013</b> | <b>100m Open Reel Fibreglass Sterling Tape Measure</b>            | <b>147</b> |
| OF3013         | 30m Open Reel Fibreglass Sterling Tape Measure                    | 147        |
| OF5013         | 50m Open Reel Fibreglass Sterling Tape Measure                    | 147        |
| <b>P-1</b>     | <b>Light Duty Universal Deburring Blades</b>                      | <b>225</b> |
| P-2            | Light Duty Brittle Material Deburring Blades                      | 225        |
| P-3            | Light Duty Sheet Deburring Blades                                 | 225        |
| PSEB-25        | Plastic Single-Edged Blade (x25)                                  | 194        |
| PSEB-5         | Plastic Single Edge Scraper and 5pkt Blades                       | 194        |
| <b>RB-01</b>   | <b>45mm Rotary Cutter Blade</b>                                   | <b>208</b> |
| RB-01-2        | 45mm Rotary Cutter Blade (x50)                                    | 208        |
| RB-03          | 28mm Rotary Cutter Blade (x2 blades)                              | 207        |
| RB-60          | 60mm Rotary Cutter Blade  | 208        |
| RC-11          | BANDO KNIFE - SHEFFIELD   | 55         |

| <i>Stock Code</i> | <i>Description</i>                           | <i>Page No.</i> |
|-------------------|--|-----------------|
| RC02              | 28mm Rotary Cutter                           | 135             |
| RC12              | 45mm Rotary Cutter                           | 135             |
| RCM4x10           | 4 x 10ft (1200 x 3000mm) Cutting Mat         | 131             |
| RCM4x12           | 4 x 12ft (1200 x 3600mm) Cutting Mat         | 131             |
| RCM4x8            | 4 x 8ft (1200 x 2400mm) Cutting Mat          | 131             |
| RCM5x10           | 5 x 10ft (1500 x 3000mm) Cutting Mat         | 131             |
| RCM5x12           | 5 x 12ft (1500 x 3600mm) Cutting mat         | 131             |
| RCM5x8            | 5 x 8ft (1500 x 2400mm) Cutting Mat          | 131             |
| RCM6x10           | 6 x 10ft (1800 x 3000mm) Cutting Mat         | 131             |
| RCM6x12           | 6 x 12ft (1800 x 3600mm) Cutting Mat         | 131             |
| RSKB-2            | Blade for SK-6                               | 44              |
| RTC25             | Leather Holster                              | 59              |
| <b>S-12</b>       | <b>Sheet &amp; Rib Deburring Blade (x2)</b>  | <b>226</b>      |
| S-18              | Slim-Trim Metal Snap Cutter                  | 37              |
| S-701             | Thread Snip                                  | 119             |
| SB-06             | Perforated Blade                             | 207             |
| SB-50H            | KDS 9mm Small Snap Blade (x50)               | 191             |
| SB-50SH-S         | KDS 9mm Stainless Steel Snap Blades (x50)    | 191             |
| SB411             | Wire Brush with Scraper                      | 99              |
| SCR-6-MK          | Combo Scraper Handle                         | 222             |
| SCR-6             | Combo Scraper Blade                          | 226             |
| SDT-SET           | Sheet Deburrer Set                           | 223             |
| SEB-10            | Single Edge Razor Blade (x10)                | 194             |
| SGS-25            | Metal Scraper with Rubber Soft Grip.         | 88              |
| SK-6              | Oifa Auto Guard Cutter                       | 44              |
| SK-8              | Oifa Safety Knife                            | 43              |
| SKB-8             | Blade for SK-8                               | 43              |
| SL-1P             | Safety Cutter                                | 45              |
| SM-90             | Poultry Blade- Carbon Steel (x100)           | 214             |
| SMOR              | Red Retractable Keyhole Knife                | 128             |
| SRK-B6            | Allway Slide Lever Safety Knife              | 44              |
| SRK-B6L           | Allway Slide Lever Safety Knife              | 44              |
| SSK               | Allway Controlled Depth Safety Knife         | 46              |
| SST10-30DH        | 30m KDS S/S Speed Winder Open Tape Measure   | 151             |
| SST10-50DH        | 50m KDS S/S Speed Winder Open Tape Measure   | 151             |
| ST13-01BP         | 1M Left to Right Bench Tape                  | 151             |
| ST13-02BP         | 2M Left to Right Bench Tape                  | 151             |
| ST13-05BP         | 5M Left to Right Bench Tape                  | 151             |
| STB13-01BP        | 1M Right to Left Bench Tape                  | 151             |
| STB13-02BP        | 2M Right to Left Bench Tape                  | 151             |
| STB13-05BP        | 5M Right to Left Bench Tape                  | 151             |
| STC45             | Leather Holster for Knife                    | 155             |
| STC65             | Nylon Knife and Snip Holster                 | 153             |
| <b>T-SD-MK</b>    | <b>Comfort Grip Deburring Holder</b>         | <b>223</b>      |
| TBC1025           | 10M x 25mm Professional Tape Measure         | 142             |
| TBC1025I          | 10M/33ft x 25mm Professional Tape Measure    | 142             |
| TBC5019           | 5M x 19mm Sterling Professional Tape Measure | 142             |
| TBC5019I          | 5M/16ft x 19mm Professional Tape Measure     | 142             |
| TBC8025           | 8M X 25mm Sterling Professional Tape Measure | 142             |
| TBC8025I          | 8M/27ft x 25mm Professional Tape Measure     | 142             |

| <i>Stock Code</i> | <i>Description</i>                                     | <i>Page No.</i> |
|-------------------|--|-----------------|
| TBCM1025          | 10M Professional Magnetic Hook Tape Measure            | 142             |
| TBCM1025I         | 10M/33ft Professional Magnetic Hook Tape Measure       | 142             |
| TBCM8025          | 8M Professional Magnetic Hook Tape Measure             | 142             |
| TBCM8025I         | 8M/27ft Professional Magnetic Hook Tape Measure        | 142             |
| TC-11             | Red Tube Cutter with Replaceable Blade                 | 59              |
| TC0123            | Silver Thread Snip                                     | 119             |
| TC1025            | 10M x 25mm Double Stop Tape Measure                    | 143             |
| TC1025I           | 10M/33ft x 25mm Double Stop Tape measure               | 143             |
| TCM1025           | 10m x 25mm Sterling Tape Measure with Magnet           | 143             |
| TH128             | Orange Plastic Cutter with Metal Insert                | 36              |
| TH208             | Yellow Plastic Scraper with 1                          | 88              |
| TH48A             | Red Plastic Scraper with H/D Blade                     | 92              |
| TH6230            | 4in x 12in Heavy Duty Floor & Wall Scraper             | 93              |
| TH68              | Yellow Plastic Cutter with Metal Insert                | 31              |
| TH82B             | Replacement Blades (x10)                               | 49              |
| TL10-30DH         | 30m KDS Open Reel Steel Tape Measure                   | 151             |
| TL10-50DH         | 50m KDS Open Reel Steel Tape Measure                   | 151             |
| TLR2095           | 20m Steel Closed Reel Tape Measure                     | 145             |
| TLR3095           | 30m Steel Closed Reel Tape Measure                     | 145             |
| TLR3095I          | 30m/100ft Steel Closed Reel Tape Measure               | 145             |
| TMT3516           | 3.5m Tru-Grip Tape Measure                             | 143             |
| TMT3516I          | 3.5m/12ft Tru-Grip Tape Measure                        | 143             |
| TMT5019           | 5m Tru-Grip Tape Measure                               | 143             |
| TMT5019I          | 5m/16ft Tru-Grip Tape Measure                          | 143             |
| TMT8025           | 8m Tru-Grip Tape Measure                               | 143             |
| TMT8025I          | 8m/27ft Tru-Grip Tape Measure                          | 143             |
| TOOLB             | STERLING Tool Bag                                      | 155             |
| TPC-135           | Multi Purpose Leather holster                          | 155             |
| TSS-10            | 10in Stainless Steel Tailoring Shears                  | 117             |
| TSS-10L           | 10in Left Handed Stainless Steel Shears                | 118             |
| TSS-12            | 12in Stainless Steel Tailoring Shears                  | 117             |
| TSS-12L           | Left Handed Scissors                                   | 118             |
| TSSTS-10          | 10in Stainless Steel Tailoring Shears Serrated         | 117             |
| TSSTS-12          | 12in Stainless Steel Tailoring Shears Serrated         | 117             |
| <b>US30-112</b>   | <b>Single Edge Razor Blade #9 (x100)</b>               | <b>193</b>      |
| <b>V-2-MK</b>     | <b>Comfort Grip Edge Deburrer</b>                      | <b>222</b>      |
| V-2               | Double Ended Blade                                     | 226             |
| V-4               | 4 Way Deburring Blade                                  | 226             |
| VDT-MK            | Comfort Grip Sheet/Rib Deburrer                        | 222             |
| V8025             | 8m x 25mm V-Force Metric Measuring Tape                | 144             |
| V8025F            | 8m x 25mm V-Force Fluro Measuring Tape                 | 144             |
| V8025I            | 8m/27ft x 25mm V-Force Metric/Imperial Measuring Tape  | 144             |
| V8025IF           | 8m/27ft x 25mm Fluro V-Force Measuring Tape            | 144             |
| VT                | 4 Way Deburring Blade Holder                           | 224             |
| <b>WPSCR</b>      | <b>Wagtail Wet Pivoting Scraper</b>                    | <b>91</b>       |
| <b>XBA3020</b>    | <b>30m x 20mm 3 Speed Winder Sterling Tape Measure</b> | <b>147</b>      |
| XBA5020           | 50m x 20mm 3 Speed Winder Sterling Tape Measure        | 147             |



# Sterling®

55 Pendlebury Road  
PO BOX 687  
Cardiff NSW 2285  
Australia.

T +61 (0)2 4957 8787  
F +61 (0)2 4957 3737  
[www.sterlingtools.com.au](http://www.sterlingtools.com.au)

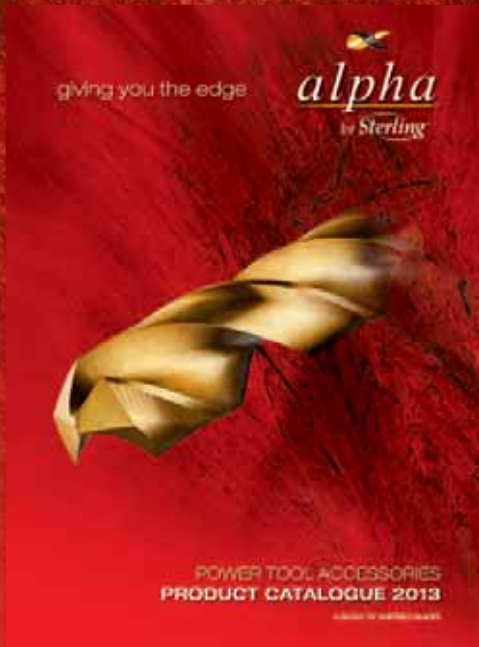

Alpha catalogue  
available on request

**SB**  
SHEFFIELD BLADES

P15



P25



P40



P48



P54



P61



P65



P68



P79



P87



P90



P103



P107



P110



P117



P142



P157



P175

